

**ROSHNI LP SOLISTA (ROLPSB)**  
**ROSHNI LP SOLISTA (ROLPSB/SV)**



ROLPSB : 0832-CPD-0132  
ROLPSB/SV : 0832-CPD-1652

EN54-3 Fire Alarm Device - Sounder  
Dispositif d'alarme incendie EN54-3 – Avertisseur d'incendie  
EN54-3 Feueralarmgerät – Töner  
Dispositivo di allarme antincendio a norma EN54-3 - Sirena  
EN54-3 Brandalarm – sounder  
Dispositivo de alarma de incendios EN54-3 – Timbre de alarma  
EN54-3 Brandvarnare – Signalgivare  
EN54-3 Urządzenie systemów SAP - Sygnalizator

EN54-3	
ROLPSB & ROLPSB/SV	
9 ~ 15VDC	18 ~ 28VDC
36mA max	
0.28mm <sup>2</sup> - 2.5mm <sup>2</sup>	
-10°C ~ +55°C	
ABS V0	
Type A = (IP21C*)	
6	

\*Product exceeds minimum requirements of EN54-3  
See www.cooperfulleon.com  
Le produit dépasse les exigences minimum de EN54-3  
Voir www.cooperfulleon.com  
Das Erzeugnis erfüllt die Mindestanforderungen von EN54-3.  
Siehe www.cooperfulleon.com  
Il prodotto supera i requisiti minimi previsti dalla norma EN54-3  
Vedi www.cooperfulleon.com  
Product overtreft de minimale vereisten van EN54-3.  
Zie www.cooperfulleon.com  
El producto excede los requisitos mínimos de la norma EN54-3  
Véase www.cooperfulleon.com  
Produkten överträffar minsta krav enligt EN54-3  
Se www.cooperfulleon.com  
Parametry techniczne produktu przekraczają minimalne  
wymagania normy PN EN54-3, szczególnie www.cooperfulleon.com

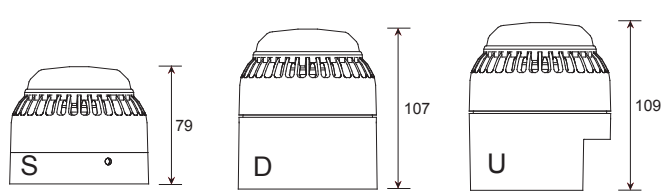
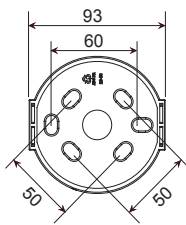

ROLPSB/SV

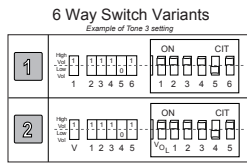

ROLPSB

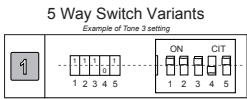

ROLPSB/SV

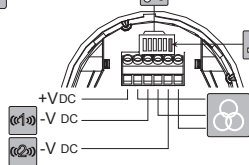

ROLPSB

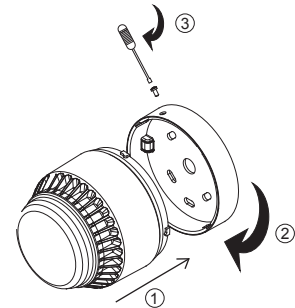
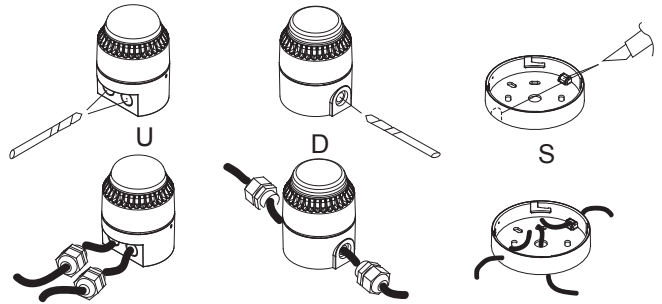
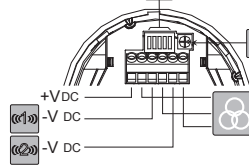

Pattern	Frequency Hz	Rate	Depiction	Main Application	Roshni LP (ROLPSB)							
					*12Vdc on axis @1M	EN54-3 15Vdc see notes	*24Vdc on axis @1M	EN54-3 28Vdc see notes	mA	dB(A)		
1	14	1111	Alternating	800 & 970	2Hz (250ms-250ms)	BS Fire	6	95	*	13	101	*
2	14	1110	Sweep	800 to 970	7Hz (7/s)	BS Fire	8	94	*	12	100	*
3	14	1101	Sweep	800 to 970	1Hz (1/s)	BS Fire	6	95	92	12	102	95
4	14	1100	Continuous	2850	Steady	General Purpose	16	99	*	32	105	*
5	4	1011	Sweep	2400 to 2850	7Hz	General Purpose	16	103	*	32	109	*
6	4	11010	Sweep	2400 to 2850	1Hz	General Purpose	16	105	*	32	112	*
7	14	11001	Slow whoop	500 to 1200	3s sweep, 0.5 s silence, then repeat	Dutch fire (NEN 2575)	6	97	93	12	103	97
8	14	11000	Sweep (DIN)	1200 to 500	1Hz	German fire (DIN 33 404)	7	96	93	15	103	94
9	4	10111	Alternating	2400 & 2850	2Hz (250ms-250ms)	General Purpose	15	99	*	31	105	*
10	14	10110	Intermittent	970	0.5Hz (1s On/1s Off)	PFEER alert	5	95	*	8	101	*
11	14	10101	Alternating	800 & 970	1Hz (500ms-500ms)	BS Fire	6	95	*	12	101	*
12	4	10100	Intermittent	2850	0.5Hz (1s On/1s Off)	General Purpose	9	99	*	17	105	*
13	14	10011	Intermittent	970	0.8Hz (250ms On/1s Off)	General Purpose	3	94	*	5	101	*
14	14	10010	Continuous	970	Steady	PFEER toxic gas	7	95	93	14	101	95
15	14	10001	Alternating	554 & 440	100ms-400ms	French fire (NFS 32-001)	8	96	*	17	102	*
16	16	10000	Intermittent	660	3.3Hz (150ms On/150ms Off)	Swedish (Air Raid)	4	94	*	6	100	*
17	17	01111	Intermittent	660	0.28Hz(1.8s On/1.8s Off)	Swedish (Local warning)	4	95	*	7	101	*
18	18	01110	Intermittent	660	0.05Hz (13s Off / 6.5Hz On)	Swedish (Pre-mess)	3	95	*	6	101	*
19	19	01101	Continuous	660	Steady	Swedish (All clear)	5	95	*	10	101	*
20	20	01100	Alternating	554 & 440	0.5Hz (1s On/1s Off)	Swedish (Turn out)	7	96	*	16	102	*
21	21	01011	Intermittent	660	1Hz (500ms-500ms)	Swedish general purpose	4	94	*	6	101	*
22	14	01010	Intermittent	2850	4Hz (150ms On/100ms Off)	Pelican crossing	12	98	*	27	104	*
23	14	01001	Sweep	800 to 970	50Hz	BS Fire	6	93	*	12	100	*
24	4	01000	Sweep	2400 to 2850	50Hz	General Purpose	15	102	*	32	108	*
25	25	00111	Intermittent	970	3 x 500ms pulses, 1.5s silence, then repeat	ISO 8201	4	95	*	7	101	*
26	26	00110	Intermittent (I*)	800 to 970	3 x 500ms pulsed sweep, 1.5s silence, then repeat	ISO 8201	4	95	*	6	102	*
27	27	00101	Intermittent (I*)	970 & 800	3 x 500ms pulsed sweep, 1.5s silence, then repeat	ISO 8201	3	94	*	6	101	*
28	10	00100	Alternating	800 & 970	2Hz (250ms-250ms)	BS Fire	6	95	*	12	101	*
29	988Hz	00011	Alternating	990 & 650	2Hz (250ms-250ms) (Symphoni tones)	BS Fire	10	99	93	20	105	96
30	510Hz	00010	Alternating	510 & 610	2Hz (250ms-250ms) (Squashni Micro tones)	BS Fire	8	94	91	16	100	92
31	14	00001	Sweep	300 to 1200	1Hz	General Purpose	10	98	*	14	103	*
32	510Hz	00000	Alternating	510 & 610	1Hz (500mS-500mS)	BS Fire	8	95	*	16	100	*

- (i) Tones certified under the CPD (Fire Alarm Applications) are shown in the column marked EN54-3
- (ii) All other SPL measurements are taken 'on axis' & are not third party verified.
- (iii) Detailed EN54-3 polar SPL measurements are available in M96-024
- (iii) A SPL of at least 65dB(A) is achieved in at least one direction at minimum volume/voltage.
- (i) Les tons certifiés dans le cadre de la DPC (application alarme incendie) sont indiqués dans la colonne intitulée EN54-3.
- (ii) Toutes les autres mesures NPA sont relevées « sur axe » et ne sont pas vérifiées par un tiers.
- (iii) Les mesures NPA polaires détaillées EN54-3 sont disponibles dans M96-024
- (i) Die nach CPD (Feuermelderanwendung) zertifizierten Töne sind in Spalte EN54-3.
- (ii) Alle anderen Schalldruckmessungen wurden vom akustischen Mittelpunkt ab gelesen und von keiner unabhängigen Stelle verifiziert.
- (iii) Detaillierte Polar-SPL-Messungen gemäß EN54-3 sind erhältlich in M96-024
- (i) I toni della sirena certificati CPD (applicazione allarme antincendio) sono indicate nella colonna contrassegnata con EN54-3.
- (ii) Tutte le altre misurazioni SPL sono state rilevate "sull'asse" e non sono state verificate da terzi.
- (iii) Le misurazioni SPL polari ai sensi della norma EN54-3 sono disponibili in M96-024
- (i) U vind tonen die onder CPD (brandalarmtoepassing) zijn gecertificeerd, in de kolom waar EN54-3 staat vermeld.
- (ii) Alle andere SPL-afmetingen zijn via de 'as' gedaan en niet door derden geverifieerd.
- (iii) Uitgebreide polaire SPL-afmetingen voor EN54-3 zijn beschikbaar in M96-024

- (i) Los sonidos certificados por el CPD (aplicación para alarmas de incendios) se muestran en la columna marcada con EN54-3.
- (ii) Cualquier otra medida del SPL (nivel de intensidad acústica) se toma "sobre el eje" y no está verificada por terceras partes.
- (iii) Las medidas detalladas del SPL polar EN54-3 están disponibles en M96-024
- (i) Signaler som är certifierade för CPD (brandvarnare) visas i kolumnen märkt EN54-3.
- (ii) Alla övriga mätningar av ljudtrycket har genomförts "direkt intill" och är inte bekräftade av tredje part.
- (iii) Detaljerade polära mätningar av ljudtrycket enligt EN54-3 finns under M96-024
- (i) Sygnaly tonowe zgodne z certyfikatem CPD dla systemów sygnalizacji pożaru wskazane są w kolumnie EN54-3.
- (ii) Wszystkie pomiary SPL są wykonane w osi sygnalizatora i nie były poddane weryfikacji przez inną stronę.
- (iii) Szczegółowe pomiary kątowych SPL wg EN54-3 dostępne są w M96-024.

CE marking under the CPD was affixed on: (see batch code on product)  
La marque CE dans le cadre de la DPC a été apposée le : (voir code de lot sur le produit)  
CE-Kennzeichnung unter dem CPD angebracht am: (siehe Chargencode am Erzeugnis).  
La marcatura CE ai sensi della direttiva CPD è stata apposta su: (vedi codice sul prodotto)  
CE-markering onder CPD is toegevoegd d.d.: (zie batchcode op het product)  
CE-märkning enligt CPD fästes på: (se satskod på produkten)  
Oznakowanie CE i CPD zostało naniesione na produkt.  
Fullleon Ltd, Cwmbran, South Wales, U.K.  
www.cooperfulleon.com