

ISC-PPR1-W16G



EN | Installation Instructions
Professional Series
PIR Detector

1.0 General Information

The ISC-PPR1-W16x Professional Series PIR Detectors are exceptionally suited for commercial indoor applications. Sensor data fusion technology ensures that the detectors send alarm conditions based on precise information. Tri-focus optics eliminate coverage gaps and respond efficiently to intruders. The powerful combination of unique features in the Professional Series delivers superior catch performance and virtually eliminates false alarms. The self-locking two-piece enclosure, built-in bubble level, flexible mounting height, and three optional mounting brackets simplify installation and reduce service time.

2.0 Installation Procedure

Do Not:

- **Mount outdoors**
- **Point toward windows**
- **Install facing direct sunlight**
- **Point towards fireplaces or air conditioners**
- **Install near moving objects such as ceiling fans**

The ISC-PPR1 is immune to small animals weighing less than 10 lb. (4.5 kg). The small animal immunity feature was not investigated by UL.

Mount the detector so that it is between 7 ft and 10 ft from the floor (2.1 m - 3 m).

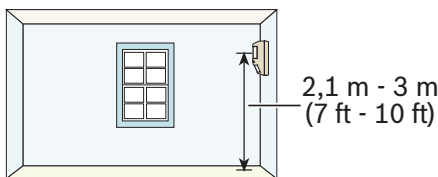

Mount the detector so that a person walks across the detection pattern.

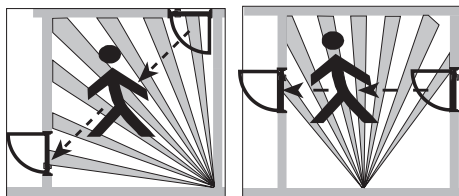

Typical mounting locations

1.1 Unlock and remove the cover

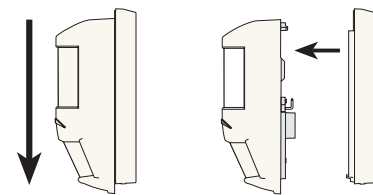
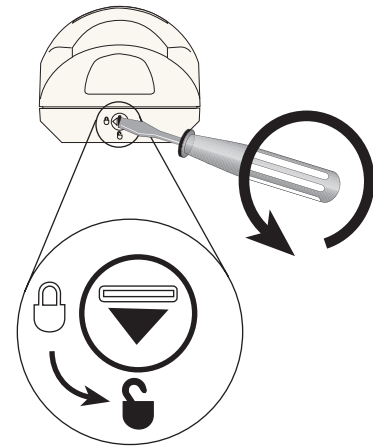

The cover lock snaps back to the locked position when the cover is removed. The cover must be reattached with the lock in the locked position.

2.2 Mounting Level

The detector has a built-in level which can be moved to measure on two axes.

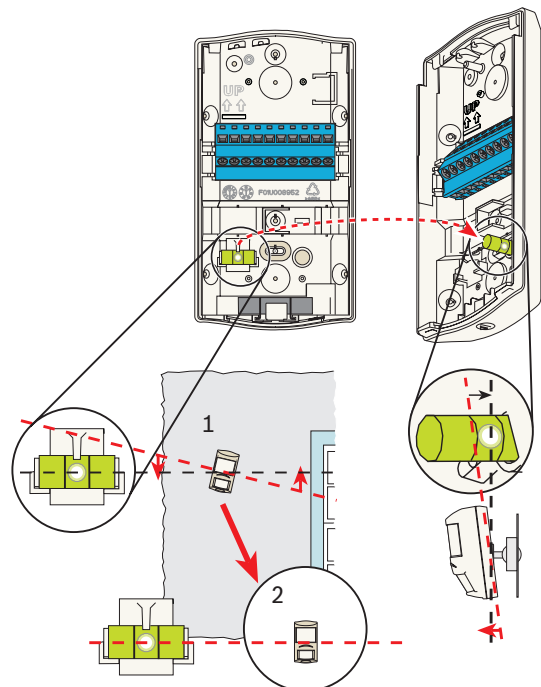

2.3 Mounting the detector

Use the hardware provided. The plastic mounting anchors require a 3/16 (5 mm) hole.

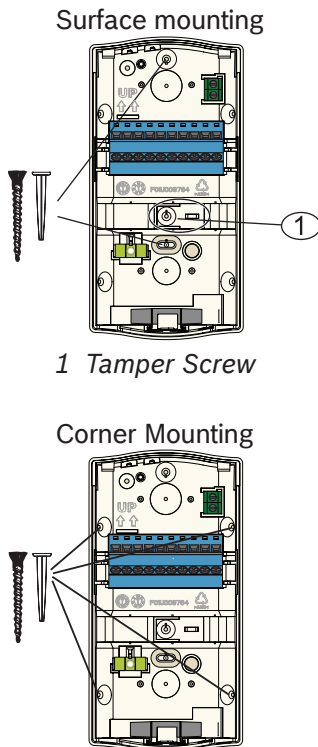

2.4 Wiring the detector

Wire sizes between 16 AWG and 26 AWG (0.2 mm² and 1 mm²) are permitted. Install the wiring using the appropriate knock-outs and tie-downs.

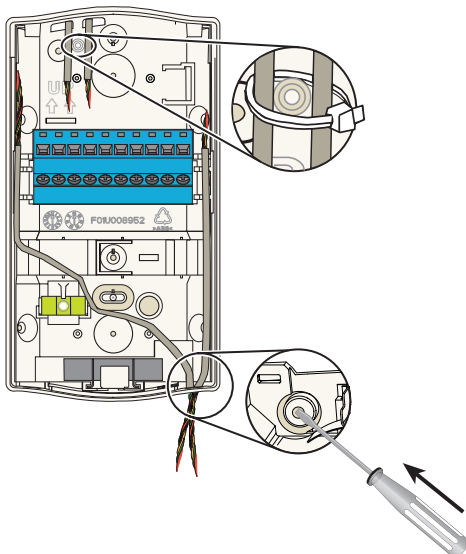

2.5 Wiring the terminal blocks

The detector has two terminal blocks. One block is used for primary wiring; the other has two spare terminals. The two spare terminals are normally used as tie points for the EOL resistor.

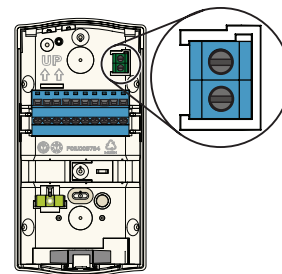
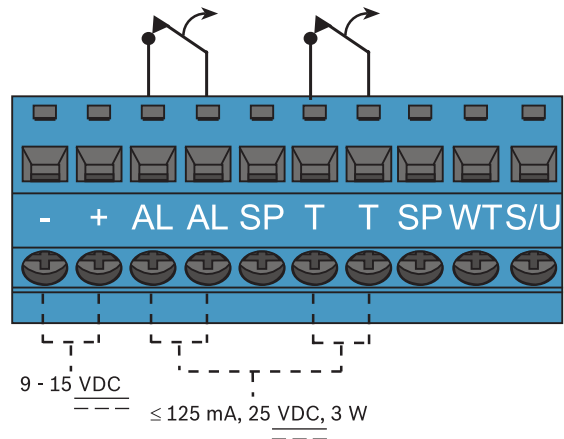

Do not attempt to remove the terminal blocks from the cover. This could result in permanent damage to the detector.

3.0 Switch Settings

3.1 Switch 1 - Walk Test

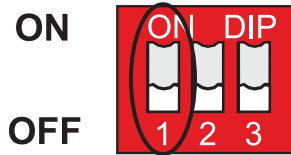

Switch 1	Voltage on WT Terminal	Walk Test
ON	0	ON
ON	+12	OFF
OFF	0	OFF
OFF	+12	ON

The Remote Self Test automatically occurs when the walk test changes from a disabled to enabled by a change in the voltage on the WT terminals.



A passing Remote Self Test responds with an alarm signal.

The Remote Self Test must be connected to 0 or +12 VDC on UL listed Control Panels.

3.2 Switch 2 - Alarm Memory Polarity



Switch 2	Voltage on S/U Terminal	Alarm Memory
ON	+12	ON (Locked)
ON	0	OFF (Unlocked)
OFF	0	ON (Locked)
OFF	+12	OFF (Unlocked)

The Alarm Memory must be connected to 0 or +12 VDC on UL listed control panels.

3.3 Switch 3 - Short Range/ Long Range

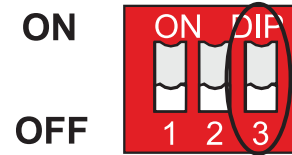

Switch 3	Range	Distance
ON	Short	25 ft (8 m)
OFF	Long	50 ft (16 m)

4.0 LED Indicators

Color	Indication	Function
Blue	Steady ON	New alarm detected
Blue	Flashing 1/4 sec ON, 1/4 sec OFF	Alarm Memory
Blue	4 Flashes	Self Test/ Self Test failure
Blue	5 Flashes	Low Input Power

5.0 Setup

5.1 Walk Test

If Switch 1 is ON and no connections are made to the WT terminal, the local Walk Test is always on. For switch settings refer to Section 3.1 Switch 1 - Walk Test on page 4.

To perform the Walk Test, walk across the detection pattern.

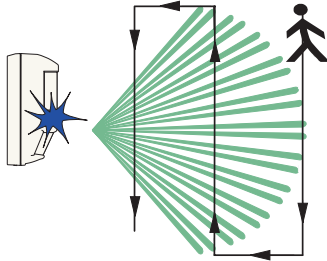

5.2 Alarm Memory

If Switch 2 is ON and no connections are made to the S/U terminal, the Alarm Memory is OFF. For switch settings refer to Section 3.2 Switch 2 - Alarm Memory Polarity on page 4.

Alarm memory flashes the alarm LED to indicate stored alarms for use in multiple unit applications. A switched voltage from the control panel controls the alarm memory.

The Alarm Memory function is used when more than one detector is connected to an alarm loop. The Alarm Memory identifies the units experiencing an alarm in the last armed period. The detector stores the alarm event in memory during the armed period. It shows the stored alarm when the system is disarmed. The LED flashes to indicate the stored alarm. Alarm Memory clears when the system is re-armed.

5.3 Trouble Memory

Pulsing the WT Terminals recalls the last trouble condition from the memory. Refer to Section 4.0 LED Indicators on page 4 for the trouble conditions.

When the memory is recalled, it clears automatically after 12 hours.

5.4 Short Range/Long Range

For switch settings refer to Section 3.3 Switch 3 - Short Range/Long Range on page 4. If Switch 3 is in the ON position the coverage pattern is 25 ft x 33 ft (8 m x 10 m). If Switch 3 is in the OFF position the coverage pattern is 50 ft x 70 ft (16 m x 21 m).

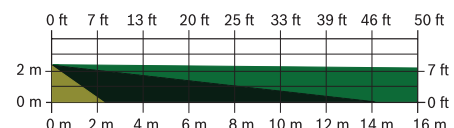
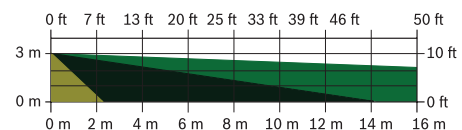
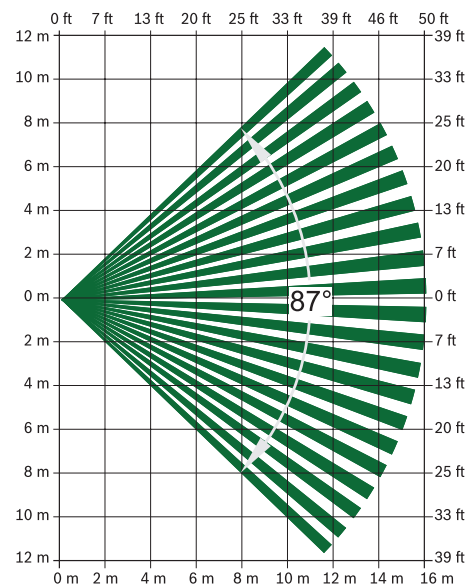
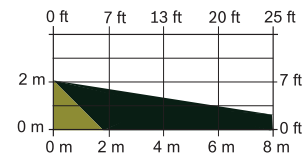
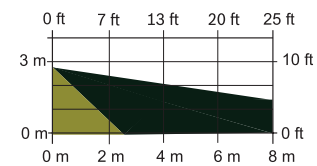
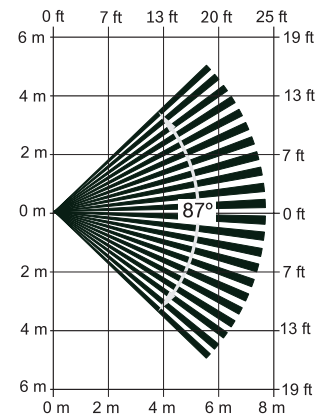

6.0 Specifications

Electrical

Power Requirements

Voltage (Operating): 9 VDC to 15 VDC

Current (Maximum): 15 mA. Current (Standby): 10 mA

Outputs

Relay: Solid state relay, normally-closed (NC) contacts power supervised.

3 W, 125 mA, 25 VDC, resistance < 10 Ω .

Tamper: Normally-closed (NC) contacts (with cover on) rated at 25 VDC, 125 mA maximum.

Connect tamper circuit to 24-hour protection circuit.

Trouble: Solid-state relay normally-closed (NC) contacts.

Mechanical

Enclosure Design

Color: White

Dimensions: 5.0 in. x 2.75 in. x 2.25 in.

(127 mm x 69 mm x 58 mm)

Material: High-impact ABS plastic

Indicators

Alarm Indicators:

- Blue LED for alarms

Detection Zones

Zones: 86

Frequency Information

Radio Frequency Interference (RFI) immunity:

No alarm or setup on critical frequencies in the range from 26 MHz to 1 GHz at 50 V/m.

Environmental

Relative Humidity: 0 to 95%, non-condensing

Temperature (Operating and Storage):

-20°F to +130°F (-29°C to +55°C)

For UL Certificated installations, +32°F to +120°F (0°C to +49°C)

Environmental Class II EN 50130-5

Protection Rating: IP41, IK04 (EN 60529, EN 50102)