

ROBOTICS

Operating manual

RobotStudio

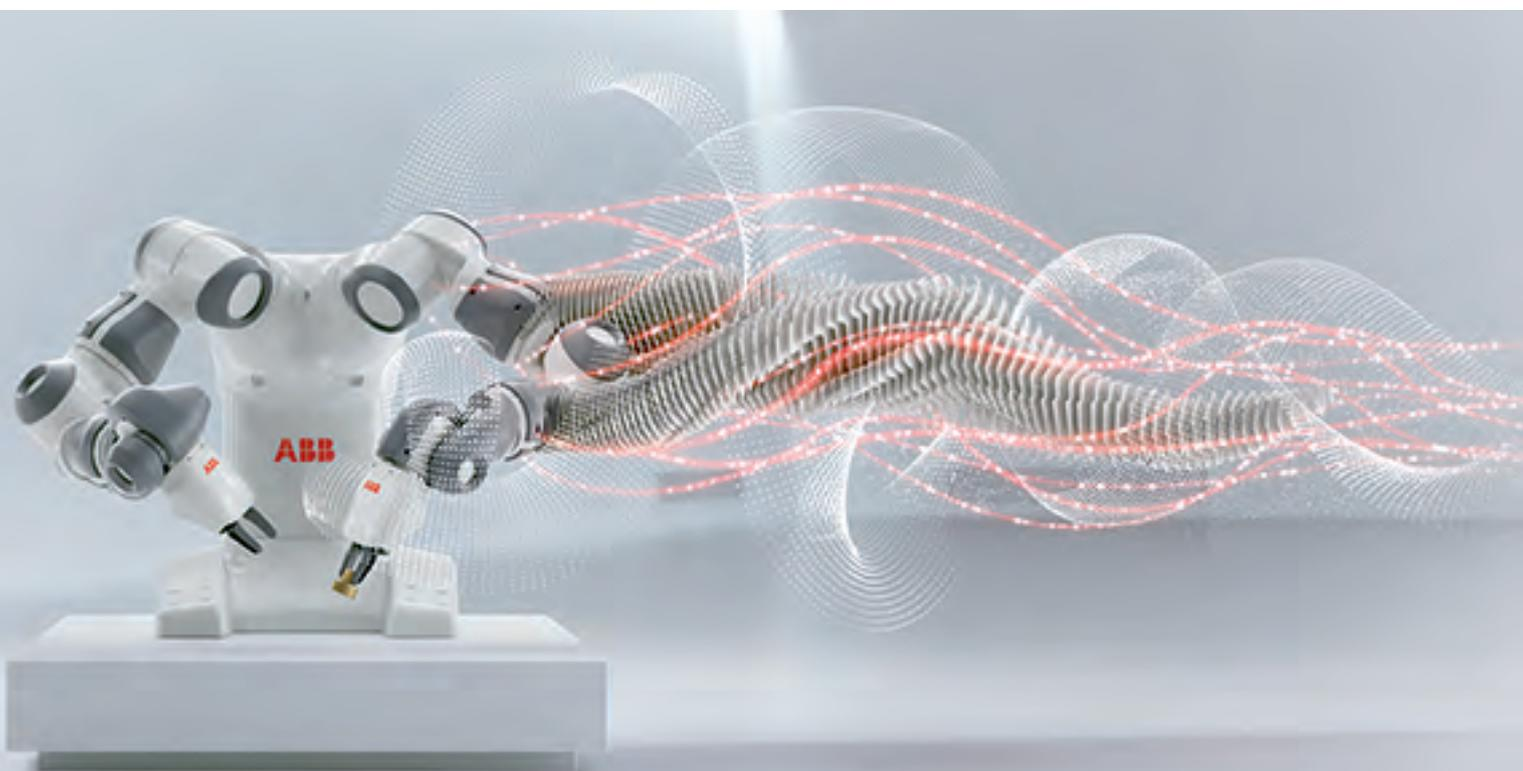

Trace back information:
Workspace R17-2 version a11
Checked in 2017-09-20
Skribenta version 5.1.011

Operating manual
RobotStudio

6.06

Document ID: 3HAC032104-001

Revision: V

The information in this manual is subject to change without notice and should not be construed as a commitment by ABB. ABB assumes no responsibility for any errors that may appear in this manual.

Except as may be expressly stated anywhere in this manual, nothing herein shall be construed as any kind of guarantee or warranty by ABB for losses, damages to persons or property, fitness for a specific purpose or the like.

In no event shall ABB be liable for incidental or consequential damages arising from use of this manual and products described herein.

This manual and parts thereof must not be reproduced or copied without ABB's written permission.

Keep for future reference.

Additional copies of this manual may be obtained from ABB.

Original instructions.

© Copyright 2008-2017 ABB. All rights reserved.

ABB AB, Robotics
Robotics and Motion
Se-721 68 Västerås
Sweden

Table of contents

Overview of this manual	13
Product documentation, IRC5	20
Safety	22
Network security	23
1 Introduction to RobotStudio	25
1.1 What is RobotStudio	25
1.2 Terms and concepts	26
1.2.1 Hardware concepts	26
1.2.2 RobotWare concepts	28
1.2.3 RAPID concepts	30
1.2.4 Concepts of programming	31
1.2.5 Targets and paths	32
1.2.6 Coordinate systems	33
1.2.7 Robot axis configurations	39
1.2.8 Libraries, geometries and CAD files	41
1.3 Installing and licensing RobotStudio	44
1.3.1 Installation options and prerequisites	44
1.3.2 Activating RobotStudio	45
1.4 User interface	52
1.4.1 Ribbon, tabs and groups	52
1.4.2 Layout browser	53
1.4.3 The Paths & Targets browser	54
1.4.4 The Controller browser	55
1.4.5 Files browser	57
1.4.6 Add-Ins browser	58
1.4.7 Windows layout	59
1.4.8 The Output window	60
1.4.9 The Controller Status window	61
1.4.10 The Operator Window	63
1.4.11 The Documents window	65
1.4.12 Using a mouse	72
1.4.13 3D Mouse	73
1.4.14 Selecting an item	74
1.4.15 Attaching and detaching objects	75
1.4.16 Keyboard shortcuts	76
2 Building stations	81
2.1 Workflow of building a station	81
2.2 Setting the Conveyor tracking station	83
2.2.1 Setting Conveyor tracking	83
2.3 Creating a system with external axes automatically	85
2.4 Manually setting up system based on RobotWare 5.xx with track motion	88
2.4.1 Track motion of type RTT or IRBTx003	88
2.4.2 Track motion of type IRBTx004	89
2.5 Virtual controller	90
2.5.1 Starting a VC	90
2.5.2 Restarting a VC	91
2.6 Station components	92
2.6.1 Importing a station component	92
2.6.2 Troubleshooting and optimizing geometries	94
2.7 Modeling	96
2.7.1 Objects	96
2.7.2 Mechanisms	98
2.7.3 Tools and tooldata	99
2.7.4 Setting the local origin of an object	100

Table of contents

2.8	Placement	101
2.8.1	Placing objects	101
2.8.2	Placing external axes	102
2.8.3	Placing robots	104
3	Programming robots	107
3.1	Workflow for programming a robot	107
3.2	Workobjects	108
3.3	Jogging mechanisms	109
3.4	Targets	110
3.5	Paths	112
3.6	Orientations	116
3.7	RAPID Instructions	120
3.8	Testing positions and motions	127
3.9	Programming MultiMove systems	129
3.9.1	About programming MultiMove	129
3.9.2	Setting up the MultiMove	131
3.9.3	Testing the MultiMove	132
3.9.4	Tuning the motion behavior	133
3.9.5	Creating paths	135
3.10	Programming external axes	136
3.11	Loading and saving programs and modules	138
3.12	Synchronization	139
4	Deploying and distributing	141
4.1	Copying programs	141
4.2	Pack & Go / Unpack & Work	142
4.3	Screen Capture	143
5	Simulating programs	145
5.1	Simulation Overview	145
5.2	Detecting collisions	147
5.3	Creating an event	150
5.4	Simulating I/O signals	151
5.5	Enabling simulation monitoring	152
5.6	Measuring simulation time	153
6	Working online	155
6.1	Connecting a PC to the controller	155
6.2	Network settings	159
6.3	User Authorization	162
6.4	The System Builder	164
6.4.1	About System Builder	164
6.4.2	Viewing system properties	166
6.4.3	Building a new system	167
6.4.4	Modifying a system	171
6.4.5	Copying a system	175
6.4.6	Creating a system from backup	176
6.4.7	Downloading a system to a controller	177
6.4.8	Creating boot media	178
6.4.9	Examples using the System Builder when offline	179
6.4.9.1	A system with support for one robot and one positioner external axis	179
6.4.9.2	Options settings for systems with positioners	182
6.5	The Installation Manager	183
6.5.1	About Installation Manager	183
6.5.2	Startup and settings	184
6.5.3	Building a new system	185
6.5.4	Modifying a system	187

6.5.5	Copying a system	189
6.5.6	Creating a system from backup	191
6.5.7	Renaming a system	193
6.5.8	A MultiMove system with two coordinated robots	194
6.5.9	The recovery disk function	196
6.6	Handle I/O	198
6.7	Configure systems	199
6.8	Handle events	205
7	File tab	209
7.1	Overview	209
7.2	New tab	211
7.3	Share	213
7.3.1	Pack and Go	213
7.3.2	Unpack and Work	214
7.3.3	Station Viewer	215
7.4	Options	217
8	Home tab	225
8.1	Overview	225
8.2	ABB Library	226
8.3	Import Library	227
8.4	Robot System	228
8.4.1	Robot System	228
8.4.2	External Axis Wizard	231
8.5	Import Geometry	234
8.6	Export Geometry	235
8.7	Frame	236
8.7.1	Frame	236
8.7.2	Frame from Three Points	237
8.8	Workobject	239
8.9	Tooldata	240
8.10	Target	241
8.10.1	Teach Target	241
8.10.2	Create Target	242
8.10.3	Create Jointtarget	244
8.10.4	Create Targets on Edge	245
8.11	Empty Path	247
8.12	AutoPath	248
8.13	MultiMove	250
8.14	Teach Instruction	258
8.15	Move Instruction	259
8.16	Action Instruction	260
8.17	Instruction Template Manager	261
8.18	Settings	262
8.18.1	Task	262
8.18.2	Workobject	263
8.18.3	Tool	264
8.19	The Freehand Group	265
8.19.1	Rotate	266
8.19.2	Jog Joint	267
8.19.3	Jog Linear	268
8.19.4	Jog Reorient	269
8.19.5	MultiRobot Jog	270
8.20	Graphics Tools	271
8.20.1	View Tab	272
8.20.2	Edit Tab	279

9	Modeling tab	281
9.1	Overview	281
9.2	Component Group	282
9.3	Empty Part	283
9.4	Smart Component	284
9.4.1	Smart Component	284
9.4.2	Smart Component Editor	285
9.4.3	The Compose tab	286
9.4.4	The Properties and Bindings tab	289
9.4.5	The Signals and Connections tab	292
9.4.6	The Design tab	295
9.4.7	Basic Smart Components	296
9.4.8	Property Editor	313
9.4.9	The Simulation Watch window	314
9.5	Tags	316
9.6	Selection of Objects	317
9.7	Solid	318
9.8	Surface	322
9.9	Curve	324
9.10	Border	330
9.11	Intersect	332
9.12	Subtract	333
9.13	Union	334
9.14	Extrude Surface or Curve	335
9.15	Line from Normal	337
9.16	The Measure Group	338
9.17	Create Mechanism	339
9.18	Create Tool	346
9.19	Physics Tools	348
10	Simulation tab	351
10.1	Overview	351
10.2	Create Collision Set	352
10.3	Simulation Setup	353
10.4	Event Manager	355
10.5	Station Logic	361
10.6	Activate Mechanical Units	362
10.7	Simulation Control	363
10.8	I/O Simulator	364
10.9	Monitor	366
10.10	Stopwatch	367
10.11	Signal Analyzer	368
10.11.1	Signal Analyzer for both real and virtual controllers	368
10.11.2	Signal Setup	369
10.11.3	Layout and usage	373
10.11.4	History	376
10.12	Record Movie	377
10.13	Conveyor Tracking Mechanism	378
10.13.1	Conveyor Tracking	378
10.13.2	Conveyor Simulation	379
11	Controller tab	381
11.1	Real and virtual controllers	381
11.2	Features for both virtual and real controllers	382
11.2.1	Add Controller	382
11.2.2	Events	385
11.2.3	Inputs/Outputs	386
11.2.4	ScreenMaker	388

11.2.5	Restart a controller	390
11.2.6	Back up a system	392
11.2.7	Restore a system	394
11.2.8	System Builder	396
11.2.9	Installation Manager	397
11.2.10	Configuration editor	398
11.2.11	Load Parameters	400
11.2.12	Save Parameters	401
11.2.13	Transfer	402
11.2.14	Signal Analyzer Online	405
11.2.15	Safety Configuration	407
11.2.16	Collision Avoidance	408
11.3	Features for real controllers	409
11.3.1	Request Write Access	409
11.3.2	Release Write Access	410
11.3.3	Authenticate	411
11.3.4	File transfer	412
11.3.5	FlexPendant Viewer	414
11.3.6	Import Options	415
11.3.7	Properties	416
11.3.8	Go Offline	419
11.3.9	Online Monitor	420
11.3.10	Visual SafeMove	422
11.3.11	User Accounts	423
11.3.12	UAS Grant Viewer	428
11.3.13	Integrated Vision	432
11.3.14	Jobs	433
11.4	Features for virtual controllers	438
11.4.1	Virtual FlexPendant	438
11.4.2	Control Panel	439
11.4.3	Shutdown	440
11.4.4	Set Task Frames	441
11.4.5	Edit System	442
12	RAPID tab	445
12.1	Overview of the RAPID tab	445
12.2	Synchronize to Station	446
12.3	Synchronize to RAPID	447
12.4	Edit RAPID code	448
12.5	Find and replace RAPID code	453
12.6	Manage RAPID modules	455
12.7	Edit RAPID data	457
12.8	Manage RAPID files and backups	458
12.9	Manage RAPID code on the controller	459
12.9.1	Manage RAPID programs	459
12.9.2	RAPID Tasks	460
12.9.3	Run Mode	463
12.9.4	Adjust Robtargets	464
12.10	Test and debug	467
12.10.1	Commands for testing and debugging	467
12.10.2	Using the Program Pointer	468
12.10.3	Using the RAPID Profiler	470
12.11	RAPID Breakpoints window	472
12.12	RAPID Call Stack window	473
12.13	RAPID Watch window	474
12.14	Examples of using the RAPID editor	475

Table of contents

13 Add-Ins tab	477
13.1 RobotApps	478
13.1.1 Distribution package	479
13.2 Migration tools	481
13.3 Gearbox Heat Prediction	482
14 Context menus	485
14.1 Add to Path	485
14.2 Align Frame Orientation	486
14.3 Align Target Orientation	487
14.4 Attach to	488
14.5 Configurations	489
14.6 Configurations	490
14.7 Convert Frame to Workobject	491
14.8 Work envelope	492
14.9 Convert to Move Circular	493
14.10 Copy / Apply Orientation	494
14.11 Detach	495
14.12 Defeature	496
14.13 Execute Move Instruction	497
14.14 External Axis Interpolation	498
14.15 Graphic Appearance	499
14.16 Remove internal geometry	501
14.17 Go to Visualization and Go to Declaration	502
14.18 Zone visualization	503
14.19 Zone reduction	504
14.20 Interpolate Path	505
14.21 Invert	506
14.22 Jump to Target	507
14.23 Linked Geometry	508
14.24 Modify Library Component	509
14.25 Mechanism Joint Jog	510
14.26 Mechanism Linear Jog	512
14.27 Mirror Path	513
14.28 Mirror	514
14.29 Modify Curve	515
14.30 Modify External Axis	517
14.31 Modify Instruction	518
14.32 Modify Mechanism	519
14.33 Modify Tooldata	520
14.34 Modify Workobject	521
14.35 Move Along Path	522
14.36 Move to Pose	523
14.37 Offset Position	524
14.38 Place	525
14.39 Protected Smart Component	527
14.40 Remove Unused Targets	528
14.41 Rename Targets	529
14.42 Reverse Path	530
14.43 Rotate	531
14.44 Rotate Path	532
14.45 Set Local Origin	533
14.46 Set Normal to Surface	534
14.47 Set Position	535
14.48 Tool Compensation	536
14.49 Translate Path	537
14.50 View Robot at Target	538
14.51 View Tool at Target	539

15 ScreenMaker tab	541
15.1 Introduction to ScreenMaker	541
15.2 Development environment	544
15.3 Working with ScreenMaker	549
15.3.1 Managing projects	549
15.3.2 Application variables	568
15.3.3 Data binding	569
15.3.4 ScreenMaker Doctor	572
15.4 Frequently asked questions	575
15.5 Tutorial	578
15.5.1 Overview	578
15.5.2 Designing the FlexArc operator panel	579
15.5.3 Designing the screen	582
15.5.4 Building and deploying the project	588
A Technical support	589
Index	591

This page is intentionally left blank

Overview of this manual

About this manual

RobotStudio is a PC application for modeling, offline programming, and simulation of robot cells. This manual describes how to create, program and simulate robot cells and stations using RobotStudio. This manual also explains the terms and concepts related to both offline and online programming.

Usage

This manual should be used when working with the offline or online functions of RobotStudio.

Who should read this manual?

This manual is intended for RobotStudio users, proposal engineers, mechanical designers, offline programmers, robot technicians, service technicians, PLC programmers, Robot programmers, and Robot System integrators.

Prerequisites

The reader should have basic knowledge of:

- Robot programming
- Generic Windows handling
- 3D CAD programs

Organization of chapters

The operating manual is structured in the following chapters:

Chapter		Contents
1	Introduction to RobotStudio on page 25	Contains installation instructions, basic explanations of the terms and concepts related to robotics and programming, and a description of the GUI.
2	Building stations on page 81	Describes how to build stations in RobotStudio. This includes importing and configuring the equipment to be simulated, as well as testing the reachability for finding the optimal station layout.
3	Programming robots on page 107	Describes how to create robot movements, I/O signals, process instructions and logics in a RAPID program for the robots. It also describes how to run and test the program.
4	Simulating programs on page 145	Describes how to simulate and validate robot programs.
5	Deploying and distributing on page 141	Describes how to transfer systems between RobotStudio's virtual controllers and real IRC5 controllers, how to copy programs, how to package an active station for moving between RobotStudio PCs, and how to capture a screen.
6	Working online on page 155	Covers the functionality of the Minimal Installation, describing such online functions as building systems (with offline examples), handling I/O and events, and configuring systems.

Continues on next page

Chapter		Contents
7	File tab on page 209	Describes the options to create new station, create new robot system, connect to a controller, save station as viewer, and RobotStudio options.
8	Home tab on page 225	Describes the controls required for building stations, creating systems, programming paths and placing items.
9	Modeling tab on page 281	Describes the controls for creating and grouping components, creating bodies, measurements and CAD operations.
10	Simulation tab on page 351	Describes the controls for setting up, configuring, controlling, monitoring, and recording simulations.
11	Controller tab on page 381	Describes the controls for managing a real controller and also the controls for synchronization, configuration and tasks assigned to the virtual controller (VC).
12	RAPID tab on page 445	Describes the features of the RAPID editor, management of RAPID files and other controls for RAPID programming.
13	Add-Ins tab on page 477	Describes the control for PowerPacs .
14	Context menus on page 485	Describes the options available from the context menus.
15	ScreenMaker tab on page 541	Describes the ScreenMaker development tool, how to manage projects in ScreenMaker and the various menus and commands used in the application.

References

Reference	Document ID
<i>Product manual - IRC5</i> IRC5 of design M2004	3HAC021313-001
<i>Product manual - IRC5</i> IRC5 of design 14	3HAC047136-001
<i>Operating manual - IRC5 with FlexPendant</i>	3HAC050941-001
<i>Technical reference manual - RAPID overview</i>	3HAC050947-001
<i>Technical reference manual - System parameters</i>	3HAC050948-001
<i>Application manual - MultiMove</i>	3HAC050961-001
<i>Application manual - Conveyor tracking</i>	3HAC050991-001
<i>Application manual - SafeMove</i>	3HAC050974-001
<i>Application manual - Electronic Position Switches</i>	3HAC050996-001
<i>Application manual - Integrated Vision</i>	3HAC044251-001



Note

The document numbers that are listed for software documents are valid for RobotWare 6. Equivalent documents are available for RobotWare 5.

Revisions

Revision	Description
A	First revision, called RobotStudio 2008, released for Partner Days. The entire manual has been adapted to the new GUI, in which RobotStudio ^{On-line} has been integrated.
B	Released with RobotStudio 5.12. The following updates were made in the manual: <ul style="list-style-type: none"> • Conveyor Tracking on page 378 • Create Conveyor on page 339 • Conveyor Simulation on page 379 • Two robot systems sharing the same task frame position • Two robot systems having different task frame positions. • Creating a system with external axes automatically on page 85 • Track motion of type RTT or IRBTx003 on page 88 • Track motion of type IRBTx004 on page 89 • The Operator Window on page 63 • Station Viewer on page 215 • Recording the simulation on page 377 • Viewpoint • Linked Geometry on page 508
C	Released with RobotStudio 5.13. <ul style="list-style-type: none"> • Merged chapters <i>The Offline tab</i> and <i>The Online tab</i> • Added the missing information from RobotStudio Online manual. • Integrated ScreenMaker. See ScreenMaker on page 388. Added the following new content: <ul style="list-style-type: none"> • Smart Component on page 284 • The Simulation Watch window on page 314 • The Documents window on page 65 • Station Logic on page 361 • Simulation Setup on page 353 Updated the changes related to handling Task Frames. <ul style="list-style-type: none"> • Updated Modifying Task frame on page 441. • Added Placing robots on page 104. • Updated Creating a system from layout on page 228.
D	Released with RobotStudio 5.13.02. The ScreenMaker tutorial was updated. See Tutorial on page 578 .
E	Released with RobotStudio 5.14. <ul style="list-style-type: none"> • Added The Controller Status window on page 61. • Updated the sections Simulation Setup on page 353 and Simulation Control on page 363. • Moved RAPID Watch window on page 474 to the chapter <i>Common features in Online and Offline tabs</i>. • Updated The Documents window on page 65 (added <i>Station mode</i>). • Updated Creating and loading a Station Viewer on page 215 (Record to Viewer) • Added Jog Reorient on page 269. • Added The 3D View group. • Updated The Compose tab on page 286 (added <i>Export to XML</i> and updated <i>Base Component</i> menu).

Continues on next page

Revision	Description
	<ul style="list-style-type: none"> • Updated Coordinate systems on page 33 (improved task frame description). • Updated Supported 3D formats on page 42 . <p>Added the following new content:</p> <ul style="list-style-type: none"> • AutoPath on page 248 • Online Monitor on page 420 • Adjust Robtargets on page 464 • Using the RAPID Profiler on page 470 • Markup • Signal Analyzer on page 368 • External Axis Interpolation on page 498 • Auto Configuration on page 489 • The Design tab on page 295 <p>The following are the ScreenMaker updates:</p> <ul style="list-style-type: none"> • Added ScreenMaker Doctor on page 572. • Added new controls VariantButton on page 555 and Conditional-Trigger on page 556. • Updated Creating a new project on page 549 (added <i>pre-defined templates</i>). • Updated Controller object data binding on page 570 (added information on <i>shared data</i>).
F	<p>Released with RobotStudio 5.14.02.</p> <p>Added the following new content:</p> <ul style="list-style-type: none"> • Gearbox Heat Prediction • External Axis Wizard on page 231 <p>Added the following new contents in Settings tab:</p> <ul style="list-style-type: none"> • Selecting a Task on page 262 • Selecting a Workobject on page 263 • Selecting a Tool on page 264 <p>Updated Creating boot media on page 178 (added information on creating a new system)</p> <p>Added information on Logic Expression in Signals and Properties on page 296</p> <p>Added a Note for Call .Net Method in Designing screens on page 551 of the ScreenMaker tab</p> <p>Added information on I-start in Result on page 174 for the Modifying a system section</p> <p>Added information on Offs in the Note for Prerequisites on page 464 in Using Adjust Robtargets</p> <p>Added a Note for the Execute button in Using Adjust Robtargets on page 464</p> <p>Added information on Always on top in Create Markup of the Markup section</p> <p>Updated Note for Using ScreenMaker Doctor in ScreenMaker Doctor on page 572</p>
G	<p>Released with RobotStudio 5.14.02.01.</p> <p>Updated the section Activating a network license on page 47.</p>
H	<p>Released with RobotStudio 5.14.03.</p> <p>Added a note regarding the usage of .NET DLLs under Advanced Actions on page 557</p> <p>Added scenarios in Errors fixed by ScreenMaker Doctor on page 572</p> <p>Updated the procedure in Creating Markup</p>

Continues on next page

Revision	Description
	<p>Updated the note in Prerequisites on page 464 for Adjust Robtargets</p> <p>Updated the procedure for Using Adjust Robtargets on page 464</p> <p>Updated the table under LogicExpression for Signals and Properties on page 296</p> <p>Added a procedure for adding events to a menu item under CommandBar on page 555</p> <p>Updated the details for Creating autopath under AutoPath on page 248</p> <p>Updated the table showing the Supported 3D formats on page 42</p>
J	<p>Released with RobotStudio 5.15.</p> <p>In addition to the following important updates, numerous minor improvements and corrections have been made throughout the document.</p> <p>Introduced the following new chapters containing both new features and also updated features;</p> <ul style="list-style-type: none"> • Controller tab on page 381, which contain features related to real and virtual controllers. • RAPID tab on page 445, which contains features related to RAPID programming. <p>Added the following new content:</p> <ul style="list-style-type: none"> • Edit RAPID data on page 457 • Transfer on page 402 • Stopwatch on page 367 • Go to Visualization and Go to Declaration on page 502 • Offset Position on page 524 • Protected Smart Component on page 527 <p>Updated, reworked the following sections:</p> <ul style="list-style-type: none"> • Edit RAPID code on page 448 • RAPID Watch window on page 474 • Installing and licensing RobotStudio on page 44 • Virtual controller on page 90 • Screen Capture on page 143 • Pack and Go on page 213 and Unpack and Work on page 214
K	<p>Released with RobotStudio 5.15.01.</p> <ul style="list-style-type: none"> • Added section What is RAPID array on page 576. • Added a sample code snippet to the advanced option Call .Net Method. See Advanced Actions on page 557. • Added an advanced option Call FP Standard View. See Advanced Actions on page 557. • Added a note in the section Controller object data binding on page 570. • Renamed the section ScreenMaker Doctor scenarios as Errors fixed by ScreenMaker Doctor and made some updates. See Errors fixed by ScreenMaker Doctor on page 572.
L	<p>Released with RobotStudio 5.60.</p> <ul style="list-style-type: none"> • Removed all instances of VSTA, Import of S4 stations and Defeathering and updated the ScreenRecorder section. • Updated the information on Backup and save in Controller grants on page 429. • Updated the section Working online on page 155 with information on the new main computer DSQC1000. • Updated the section Overview on page 515. • Updated the section Adjust Robtargets on page 464.

Continues on next page

Revision	Description
	<ul style="list-style-type: none"> Added a new section Visualizing Safety Zones in Online Monitor on page 421 in Online Monitor. Updated the section AutoPath on page 248. Added a new section Graphics Tools on page 271. Added a new section Tags on page 316.
M	<p>Released with RobotStudio 5.61.</p> <ul style="list-style-type: none"> Added description about the General tab in Modifying Project properties on page 559 in ScreenMaker chapter. Added a new section Creating Production Screen Widget on page 563 in ScreenMaker chapter. Added a note in the section General keyboard shortcuts on page 76. Updated the section Supported 3D formats on page 42. Updated the prerequisites in the section ScreenMaker on page 388.
N	<p>Released with RobotStudio 6.0.</p> <ul style="list-style-type: none"> Added a new section on Jobs on page 433. Added a new section on About Installation Manager on page 183. Added a new section on Zone visualization on page 503. Added a new section on Zone visualization on page 503. Added a new section on RobotStudio Solutions on page 209. Added a new section on RobotApps on page 478. Added a new section on Visual SafeMove on page 422. Updated the section Installing and licensing RobotStudio on page 44.
P	<p>Released with RobotStudio 6.01.</p> <ul style="list-style-type: none"> Added a new section on Work envelope on page 492. Added a new section on I/O Signal Data Editor on page 387. Added a new section on Windows layout on page 59. Added a new table for Supported RobotWare 6 configurations for positioners, motor units, gear units and track motions on page 86. Added a new section on 3D Mouse on page 73. Added a new section on Automatic transparency on page 273.
Q	<p>Released with RobotStudio 6.02.</p> <ul style="list-style-type: none"> Added a new section on Shallow rectangle selection on page 317. Added following sections about conveyor tracking. <ul style="list-style-type: none"> Create connection between virtual controller and conveyor on page 340 Modifying the connection between VC and conveyor on page 230 Removing objects from conveyor on page 230 Create Conveyor on page 339
R	<p>Released with RobotStudio 6.03</p> <ul style="list-style-type: none"> Added a section about Renaming a system on page 193 Added a section about RAPID Breakpoints window on page 472 Added a section about RAPID Call Stack window on page 473 Added a section about Setting the IP address of the controller on page 417 Added a section about Collision Avoidance on page 408 Added a section about Selected tasks on page 467 Added a section about Calibrating the baseframe position on page 443

Continues on next page

Revision	Description
	<ul style="list-style-type: none"> • Added a section about Settings file on page 184
S	<p>Released with RobotStudio 6.03.01.</p> <ul style="list-style-type: none"> • Updated the section Network security on page 23. • Updated information about the default user in UAS, see User Authorization on page 162
T	<p>Released with RobotStudio 6.04.</p> <ul style="list-style-type: none"> • Added a new section on Options:General:Autosave on page 218. • Added a section about Options:Graphics:Stereo/VR* on page 223 • Added a section about Four Bar joint on page 343 • Updated information about the TCP Trace, see The TCP Trace tab on page 366. • Added a new section on Gravity parameters in online monitor on page 420. • Updated information about the Supported actions in Jobs, see Supported actions on page 435. • Added a new section on Jobs with several actions on page 436. • Added a new section on Running job from the Command Prompt window on page 437. • Updated the section Edit RAPID code on page 448.
U	<p>Released with RobotStudio 6.05.</p> <ul style="list-style-type: none"> • Added a new section on Deployment packages and the repository on page 183. • Added a section The recovery disk function on page 196. • Added a section Instruction Template Manager on page 261. • Added a section Virtual Reality on page 274. • Added a new section on Physics Tools on page 348. • Added a new section on RobotApps on page 478. • Minor updates in the following sections. <ul style="list-style-type: none"> - Options on page 217 - Configurations on page 489
V	<p>Released with RobotStudio 6.06.</p> <p>In addition to the following updates, numerous minor improvements and corrections have been made throughout the document.</p> <p>Following sections are added:</p> <ul style="list-style-type: none"> • RapidVariable on page 309 • PhysicsControl on page 309 • Defeature on page 496 <p>Following sections are updated:</p> <ul style="list-style-type: none"> • Supported 3D formats on page 42 • Checking reachability on page 127 • The Create Cylinder dialog box on page 319 • The Create Polyline dialog box on page 328 • The Create Spline dialog box on page 328 • Back up a system on page 392 • Restore a system on page 394 • Configurations on page 489

Product documentation, IRC5

Categories for user documentation from ABB Robotics

The user documentation from ABB Robotics is divided into a number of categories. This listing is based on the type of information in the documents, regardless of whether the products are standard or optional.

All documents listed can be ordered from ABB on a DVD. The documents listed are valid for IRC5 robot systems.

Product manuals

Manipulators, controllers, DressPack/SpotPack, and most other hardware is delivered with a **Product manual** that generally contains:

- Safety information.
 - Installation and commissioning (descriptions of mechanical installation or electrical connections).
 - Maintenance (descriptions of all required preventive maintenance procedures including intervals and expected life time of parts).
 - Repair (descriptions of all recommended repair procedures including spare parts).
 - Calibration.
 - Decommissioning.
 - Reference information (safety standards, unit conversions, screw joints, lists of tools).
 - Spare parts list with exploded views (or references to separate spare parts lists).
 - Circuit diagrams (or references to circuit diagrams).
-

Technical reference manuals

The technical reference manuals describe reference information for robotics products.

- *Technical reference manual - Lubrication in gearboxes*: Description of types and volumes of lubrication for the manipulator gearboxes.
- *Technical reference manual - RAPID overview*: An overview of the RAPID programming language.
- *Technical reference manual - RAPID Instructions, Functions and Data types*: Description and syntax for all RAPID instructions, functions, and data types.
- *Technical reference manual - RAPID kernel*: A formal description of the RAPID programming language.
- *Technical reference manual - System parameters*: Description of system parameters and configuration workflows.

Continues on next page

Application manuals

Specific applications (for example software or hardware options) are described in **Application manuals**. An application manual can describe one or several applications.

An application manual generally contains information about:

- The purpose of the application (what it does and when it is useful).
- What is included (for example cables, I/O boards, RAPID instructions, system parameters, DVD with PC software).
- How to install included or required hardware.
- How to use the application.
- Examples of how to use the application.

Operating manuals

The operating manuals describe hands-on handling of the products. The manuals are aimed at those having first-hand operational contact with the product, that is production cell operators, programmers, and troubleshooters.

The group of manuals includes (among others):

- *Operating manual - Emergency safety information*
- *Operating manual - General safety information*
- *Operating manual - Getting started, IRC5 and RobotStudio*
- *Operating manual - IRC5 Integrator's guide*
- *Operating manual - IRC5 with FlexPendant*
- *Operating manual - RobotStudio*
- *Operating manual - Troubleshooting IRC5*

Safety

Safety of personnel

A robot is heavy and extremely powerful regardless of its speed. A pause or long stop in movement can be followed by a fast hazardous movement. Even if a pattern of movement is predicted, a change in operation can be triggered by an external signal resulting in an unexpected movement.

Therefore, it is important that all safety regulations are followed when entering safeguarded space.

Safety regulations

Before beginning work with the robot, make sure you are familiar with the safety regulations described in the manual *Operating manual - General safety information*.

Network security

Network security

This product is designed to be connected to and to communicate information and data via a network interface, It is your sole responsibility to provide and continuously ensure a secure connection between the product and to your network or any other network (as the case may be). You shall establish and maintain any appropriate measures (such as but not limited to the installation of firewalls, application of authentication measures, encryption of data, installation of anti-virus programs, etc) to protect the product, the network, its system and the interface against any kind of security breaches, unauthorized access, interference, intrusion, leakage and/or theft of data or information. ABB Ltd and its entities are not liable for damages and/or losses related to such security breaches, any unauthorized access, interference, intrusion, leakage and/or theft of data or information.

This page is intentionally left blank

1 Introduction to RobotStudio

1.1 What is RobotStudio

RobotStudio is a PC application for modeling, offline programming, and simulation of robot cells.

RobotStudio allows you to work with an off-line controller, which is a virtual IRC5 controller running locally on your PC. This offline controller is also referred to as the virtual controller (VC). RobotStudio also allows you to work with the real physical IRC5 controller, which is simply referred to as the real controller.

When RobotStudio is used with real controllers, it is referred to as the online mode. When working without being connected to a real controller, or while being connected to a virtual controller, RobotStudio is said to be in offline mode.

RobotStudio offers the following installation options:

- Complete
- Custom, allowing user-customized contents and paths
- Minimal, allowing you to run RobotStudio in online mode only.

1 Introduction to RobotStudio

1.2.1 Hardware concepts

1.2 Terms and concepts

1.2.1 Hardware concepts

Overview

This section introduces the hardware in a typical IRC5 robot cell. For detailed explanations, see the manuals related to IRC5 robots specified in [References on page 14](#).

Standard hardware

The table below describes the standard hardware in an IRC5 robot cell.

Hardware	Explanation
Robot manipulator	An ABB industrial robot.
Control module	Contains the main computer that controls the motion of the manipulator. This includes RAPID execution and signal handling. One control module can be connected to 1 – 4 drive modules.
Drive module	A module containing the electronics that power the motors of a manipulator. The drive module can contain up to nine drive units, each controlling one manipulator joint. Since the standard robot manipulators have six joints, you usually use one drive module per robot manipulator.
FlexController	The controller cabinet for the IRC5 robots. It consists of one control module and one drive module for each robot manipulator in the system.
FlexPendant	The programming pendant, connected to the control module. Programming on the FlexPendant is referred to as “online programming”.
Tool	A device usually mounted on the robot manipulator to allow it to perform specific tasks, such as gripping, cutting or welding. The tool can also be stationary, see below for more information.

Optional hardware

The table below describes the optional hardware for an IRC5 robot cell.

Hardware	Explanation
Track manipulator	A moving stand holding the robot manipulator to give it a larger work space. When the control module controls the motion of a track manipulator, it is referred to as a “Track External Axis”.
Positioner manipulator	A moving stand normally holding a work piece or a fixture. When the control module controls the motion of a positioner manipulator, it is referred to as an “External Axis”.
FlexPositioner	A second robot manipulator acting as a positioner manipulator. It is controlled by the same control module as the positioner manipulator.
Stationary tool	A device that stands in a fixed location. The robot manipulator picks up the work piece and brings it to the device to perform specific tasks, such as gluing, grinding or welding.
Work piece	The product being worked on.

Continues on next page

Hardware	Explanation
Fixture	A construction holding the work piece in a specific position so that the repeatability of the production can be maintained.

1 Introduction to RobotStudio

1.2.2 RobotWare concepts

1.2.2 RobotWare concepts

Overview

This section introduces terminology regarding RobotWare. For detailed explanations, see the manuals related to IRC5 robots specified in [References on page 14](#).

RobotWare

The table below describes the RobotWare terminology and concepts that can be useful when working with RobotStudio.

Concept	Explanation
RobotWare	As a concept, refers to both the software used to create a RobotWare System and the RobotWare systems themselves.
RobotWare installation	<p>When installing RobotStudio, only one version of RobotWare will be installed. To simulate a specific RobotWare system, the RobotWare version used for this particular RobotWare system must be installed on your PC.</p> <p>RobotWare 5 is installed into the PC's program files folder using a standard PC installer. RobotWare 6 is automatically installed for the <i>Complete</i> installation option of RobotStudio. Alternatively, use the RobotApps page in the Add-Ins tab to install RobotWare 6.</p>
RobotWare Key	<p>Used when you create a new RobotWare system or upgrade an existing system. The RobotWare keys unlock the RobotWare options included in the system, and determine the RobotWare version from which the RobotWare system will be built.</p> <p>For IRC5 systems there are three types of RobotWare keys:</p> <ul style="list-style-type: none">• The controller key, which specifies the controller and software options.• The drive keys, which specify the robots in the system. The system has one drive key for each robot it uses.• add-ins specify additional options, like positioner external axes. <p>A virtual key allows you to select any RobotWare options you wish, but a RobotWare system created from a virtual key can only be used in a virtual environment such as RobotStudio.</p>
RobotWare system	<p>A set of software files that, when loaded into a controller, enables all functions, configurations, data and programs controlling the robot system.</p> <p>RobotWare systems are created in the RobotStudio software. The systems can be stored and saved on a PC, as well as on the control module.</p> <p>RobotWare systems can be edited by RobotStudio or the FlexPendant.</p>
RobotWare version	<p>Each RobotWare is released with a major and a minor version number, separated by a dot. The RobotWare version for IRC5 is 6.xx, where xx identifies the minor version.</p> <p>When ABB releases a new robot model, a new RobotWare version will be released with support for the new robot.</p>

Continues on next page

Concept	Explanation
Mediapool	<p>For RobotWare 5, the mediapool is a folder on the PC in which each RobotWare version is stored in a folder of its own.</p> <p>The files of the mediapool are used to create and implement all the different RobotWare options. Therefore, the correct RobotWare version must be installed in the mediapool when creating RobotWare systems or running them on virtual controllers.</p>
RobotWare Add-In	<p>A RobotWare add-in is a self-contained package that extends the functionality of a robot system. RobotWare add-ins are the RobotWare 6 equivalent of RobotWare 5 additional options.</p>
Product	<p>In the context of RobotWare 6, a product can be either a RobotWare version or a RobotWare add-in. Products can be free or licensed.</p>
License	<p>The license unlocks the options you can use in your robot system, for example robots and RobotWare options.</p> <p>If you wish to upgrade from RobotWare version 5.15 or earlier, you must replace the controller main computer and get RobotWare 6 licenses. Contact your ABB Robotics service representative at www.abb.com/contacts.</p>
Distribution package	<p>A Distribution package may contain RobotWare and RobotWare add-ins. RobotWare 6 Distribution package also contains RobotWare Add-Ins for Positioners and TrackMotion. For more information, see Distribution package on page 479.</p>

1 Introduction to RobotStudio

1.2.3 RAPID concepts

1.2.3 RAPID concepts

Overview

This section introduces the basic terminology of RAPID. The manuals related to RAPID and programming are listed in [References on page 14](#).

Terminology of the RAPID structure

The table below describes the RAPID terminology that you may come across when working with RobotStudio. The concepts are listed by size, from most basic to increasingly large.

Concept	Explanation
Data declaration	Used to create instances of variables or data types, like num or tooldata.
Instruction	The actual code commands that make something happen, for example, setting data to a specific value or a robot motion. Instructions can only be created inside a routine.
Move instructions	Create the robot motions. They consist of a reference to a target specified in a data declaration along with parameters that set motion and process behavior. If inline targets are used, the position is declared in the move instructions.
Action instruction	Instructions that perform other actions than moving the robot, such as setting data or sync properties.
Routine	Usually a set of data declarations followed by a set of instructions implementing a task. Routines can be divided into three categories: procedures, functions and trap routines.
Procedure	A set of instructions that does not return a value.
Function	A set of instructions that returns a value.
Trap	A set of instructions that is triggered by an interrupt.
Module	A set of data declarations followed by a set of routines. Modules can be saved, loaded and copied as files. Modules are divided into program modules and system modules.
Program module (.mod)	Can be loaded and unloaded during execution.
System module (.sys)	Used mainly for common system-specific data and routines, for example, an arcware system module that is common for all arc robots.
Program files (.pgf)	In IRC5 a RAPID program is a collection of module files (.mod) and the program file (.pgf.) that references all the module files. When loading a program file, all old program modules are replaced by those referenced in the .pgf file. System modules are unaffected by program load.

1.2.4 Concepts of programming

Overview

This section introduces the terminology regarding programming. The manuals related to programming and IRC5 Robots are listed in [References on page 14](#).

Programming concepts

The table below describes the terminology and concepts that are used in robot programming.

Concept	Explanation
Online programming	Programming when connected to a real controller. This expression also implies using the robot to create positions and motion.
Offline programming	Programming without being connected to the robot or the real controller.
True offline programming	Refers to the ABB Robotics concept of connecting a simulation environment to a virtual controller. This enables not only program creation, but also program testing and optimizing offline.
Virtual controller	A software that emulates a FlexController to allow the same software (the RobotWare system) that is controlling the robots to run on a PC. This gives the same behavior of the robots offline as you get online.
MultiMove	Running multiple robot manipulators with the same control module.
Coordinate systems	Used to define positions and orientations. When programming a robot, you can take advantage of using different coordinate systems to more easily position objects relative to each other.
Frame	A synonym for coordinate system.
Workobject calibration	If all your targets refer to workobjects, you only need to calibrate the workobjects when deploying offline programs.

1 Introduction to RobotStudio

1.2.5 Targets and paths

1.2.5 Targets and paths

Overview

Targets (positions) and paths (sequences of move instructions to targets) are used when programming robot motions in RobotStudio.

When you synchronize the RobotStudio station to the virtual controller, RAPID programs are created from the paths.

Targets

A target is a coordinate that the robot shall reach. It contains the following information:

Information	Description
Position	The position of the target, defined in a workobject coordinate system, see Coordinate systems on page 33 .
Orientation	The orientation of the target, relative to the orientation of the workobject. When the robot reaches the target, it will align the TCP's orientation with the target's orientation, see Coordinate systems on page 33 .
Configuration	Configuration values that specify how the robot shall reach the target. For more information, see Robot axis configurations on page 39 .

Targets are converted to instances of the data type *robtarg* when synchronized to the virtual controller.

Paths

A sequence of move instructions, paths are used to make the robot move along a sequence of targets.

Paths are converted to procedures when synchronized to the virtual controller.

Move instructions

A move instruction consists of:

- a reference to a target
 - motion data, such as motion type, speed and zone
 - a reference to a tooldata
 - a workobject reference
-

Action instructions

An action instruction is a RAPID string that can be used for setting and changing parameters. Action instructions can be inserted before, after or between instruction targets in paths.

1.2.6 Coordinate systems

Overview

This section provides an introduction to the coordinate systems used mostly for offline programming. In RobotStudio, you can either use the coordinate systems (that are explained below) or the user-defined coordinated systems for co-relating elements and objects.

Hierarchy

The coordinate systems are co-related hierarchically. The origin of each coordinate system is defined as a position in one of its ancestries. The following are the descriptions of the commonly used coordinate systems.

Tool Center Point Coordinate system

The tool center point coordinate system, also called TCP, is the center point of the tool. You can define different TCPs for one robot. All robots have one predefined TCP at the robot's tool mounting point, called *tool0*.

When a program runs, the robot moves the TCP to the programmed position.

RobotStudio World Coordinate system

The RobotStudio world coordinate system represents the entire station or robot cell. This is the top of the hierarchy to which all other coordinate systems are related (when using RobotStudio).

Base Frame (BF)

The base coordinate system is called the Base Frame (BF). Each robot in the station, both in RobotStudio and the real world has a base coordinate system which is always located at the base of the robot.

Task Frame (TF)

The Task Frame represents the origin of the robot controller world coordinate system in RobotStudio.

The following picture illustrates the difference between the base frame and the task frame.

Continues on next page

1 Introduction to RobotStudio

1.2.6 Coordinate systems

Continued

In the picture to the left, the task frame is located at the same position as the robot base frame. In the picture to the right, the task frame has been moved to another position.

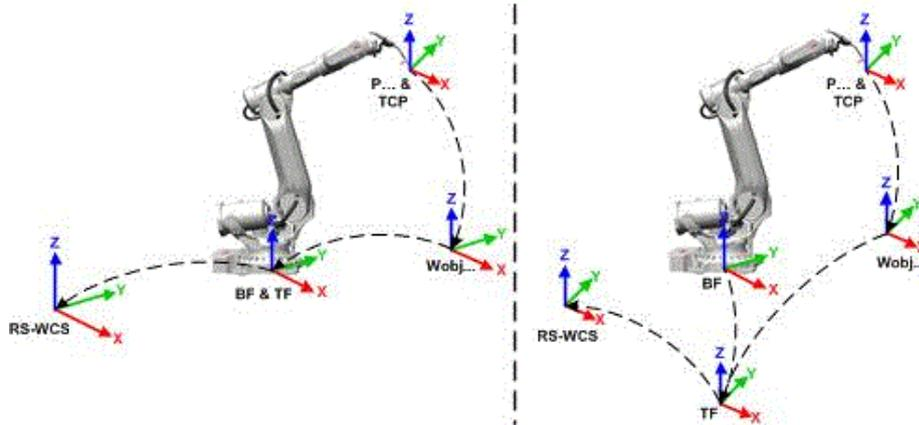

en1000001303

The following picture illustrates how a task frame in RobotStudio is mapped to the robot controller coordinate system in the real world. For example, on the shop floor.

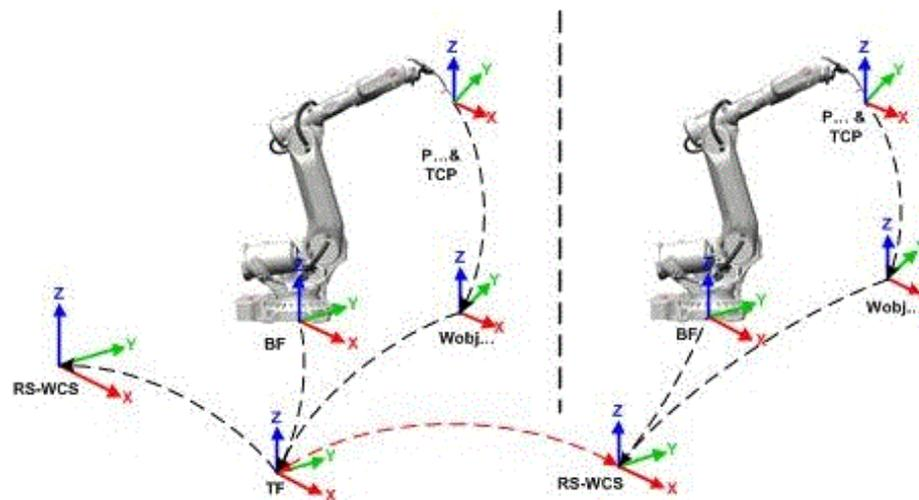

en1000001304

RS-WCS	World coordinate system in RobotStudio
RC-WCS	World coordinate system as defined in the robot controller. It corresponds to the task frame of RobotStudio.
BF	Robot Base Frame
TCP	Tool Center Point
P	Robot target
TF	Task Frame
Wobj	Workobject

Continues on next page

Stations with multiple robot systems

For a single robot system, RobotStudio's task frame corresponds to the robot controller world coordinate system. When several controllers are present in the station, the task frame allows the connected robots to work in different coordinate systems. That is, the robots can be located independent of each other by defining different task frames for each robot.

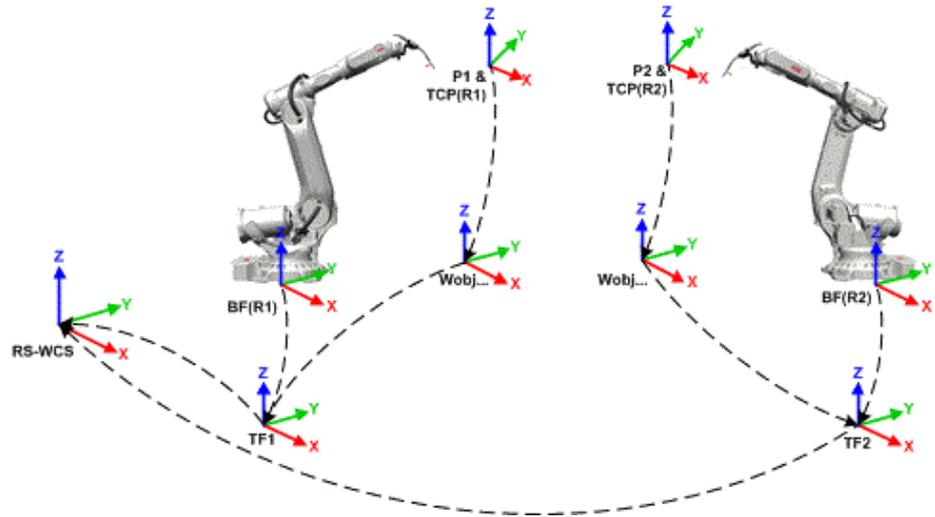

en1000001442

RS-WCS	World coordinate system in RobotStudio
TCP(R1)	Tool Center Point of robot 1
TCP(R2)	Tool Center Point of robot 2
BF(R1)	Base Frame of robot system 1
BF(R2)	Base Frame of robot system 2
P1	Robot target 1
P2	Robot target 2
TF1	Task Frame of robot system 1
TF2	Task Frame of robot system 2
Wobj	Workobject

Continues on next page

1 Introduction to RobotStudio

1.2.6 Coordinate systems

Continued

MultiMove Coordinated systems

The MultiMove functions help you create and optimize programs for MultiMove systems where one robot or positioner holds the work piece and other robots operate on it.

When using a robot system with the RobotWare option *MultiMove Coordinated*, it is important that the robots are working in the same coordinate system. As such, RobotStudio do not allow task frames of the controller to be separated.

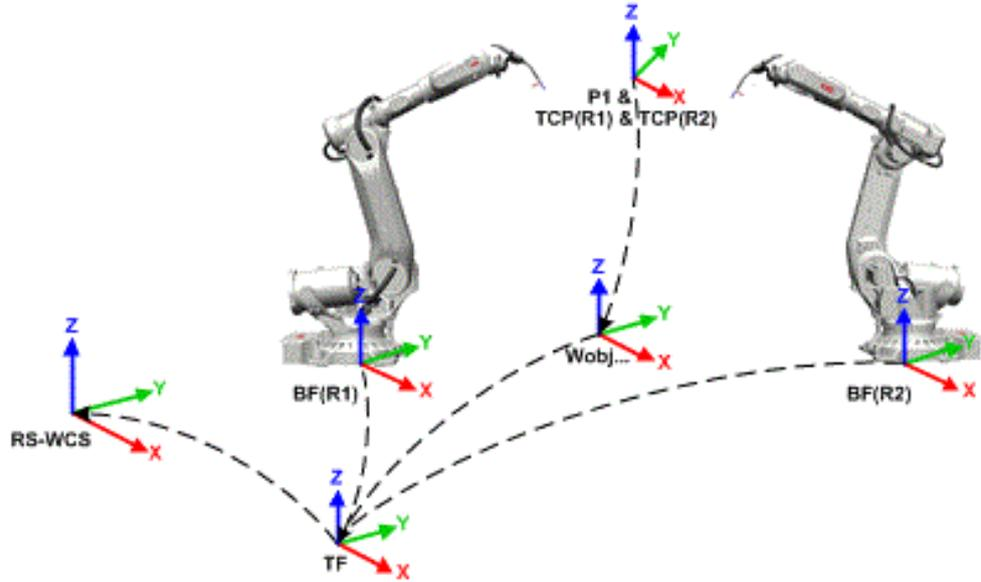

en100001305

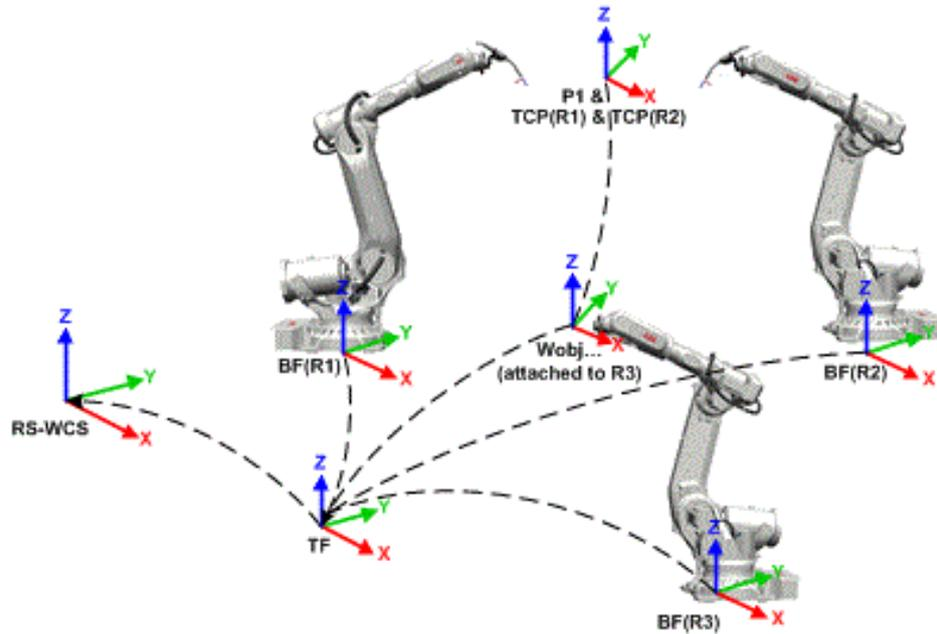

en100001306

RS-WCS	World coordinate system in RobotStudio
TCP(R1)	Tool Center Point of robot 1

Continues on next page

TCP(R2)	Tool Center Point of robot 2
BF(R1)	Base Frame of robot 1
BF(R2)	Base Frame of robot 2
BF(R3)	Base Frame of robot 3
P1	Robot target 1
TF	Task Frame
Wobj	Workobject

MultiMove Independent systems

For a robot system with the RobotWare option *MultiMove Independent*, robots operate simultaneously and independently while being controlled by one controller. Even though there is only one robot controller world coordinate system, robots often work in separate coordinate systems. To allow this setup in RobotStudio, the task frames for the robots can be separated and positioned independent of each other.

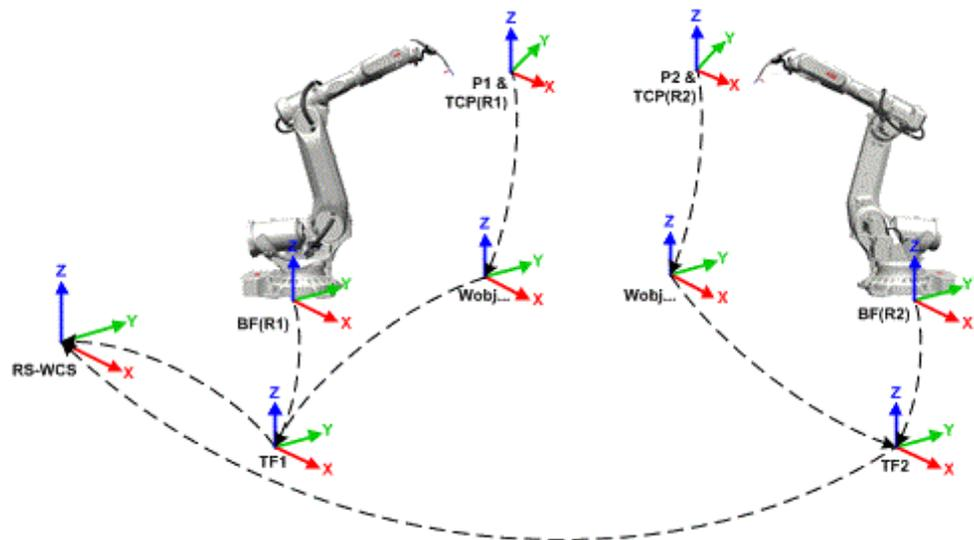

en1000001308

RS-WCS	World coordinate system in RobotStudio
TCP(R1)	Tool Center Point of robot 1
TCP(R2)	Tool Center Point of robot 2
BF(R1)	Base Frame of robot 1
BF(R2)	Base Frame of robot 2
P1	Robot target 1
P2	Robot target 2
TF1	Task Frame 1
TF2	Task Frame 2
Wobj	Workobject

Continues on next page

1 Introduction to RobotStudio

1.2.6 Coordinate systems

Continued

Workobject coordinate system

The workobject normally represents the physical work piece. It is composed of two coordinate systems: the *User frame* and the *Object frame*, where the latter is a child to the former. When programming a robot, all targets (positions) are related to the object frame of a workobject. If no other workobject is specified, the targets will be related to the default *Wobj0*, which always coincides with the base frame of the robot.

Using workobjects provides the chance to easily adjust robot programs with an offset, if the location of the work piece has been changed. Thus, workobjects can be used for calibrating offline programs. If the placement of the fixture or work piece relative to the robot in the real station does not completely match the placement in the offline station, you simply adjust the position of the workobject.

Workobjects are also used for coordinated motion. If a workobject is attached to a mechanical unit (and the system uses the option for coordinated motion), the robot will find the targets in the workobject even when the mechanical unit moves the workobject.

In the picture below the grey coordinate system is the world coordinate system, and the black ones are the object frame and the user frame of the workobject. Here the user frame is positioned at the table or fixture and the object frame at the workpiece.

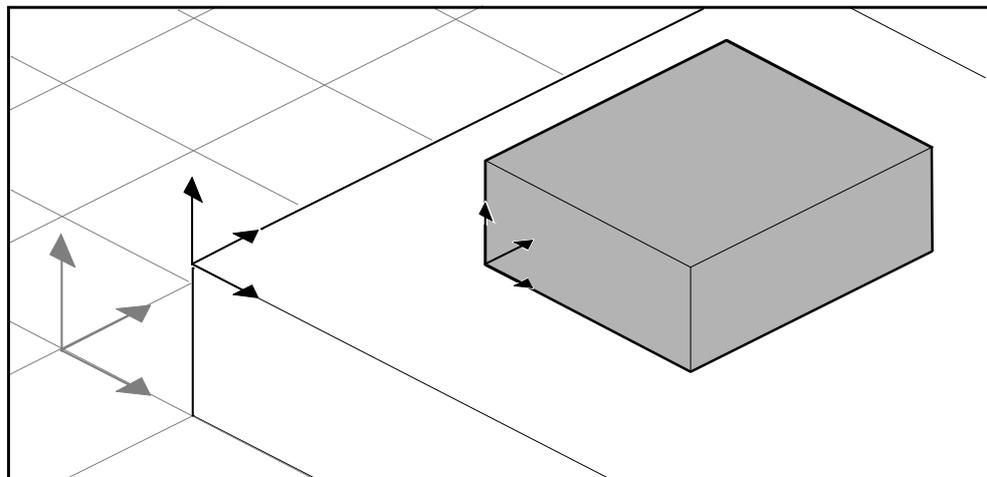

xx0500001519

User coordinate systems

User coordinate systems are used for creating reference points of your choice. For example, you can create user coordinate systems at strategic points in the work piece to simplify programming.

1.2.7 Robot axis configurations

Axis configurations

Targets are defined and stored as coordinates in a WorkObject coordinate system. When the controller calculates the position of the robot axes for reaching the target, it will often find more than one possible solution to configuring the robot axes.

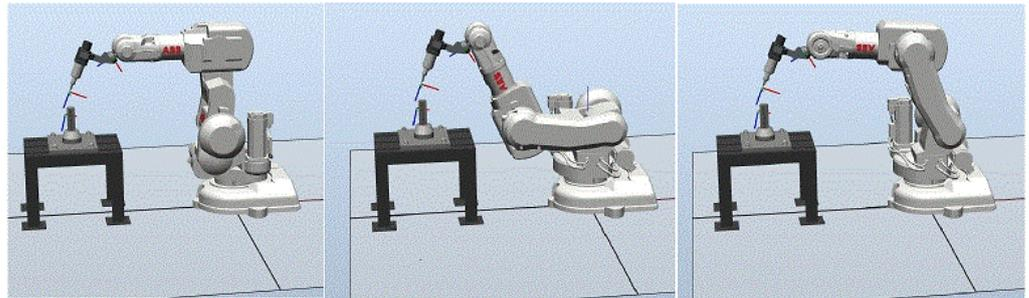

configur

To distinguish between the different configurations, all targets have a configuration value that specifies the quadrant in which each axis shall be located.

Storing axis configurations in targets

For targets that are taught after jogging the robot to the position, the used configuration will be stored in the target.

Targets created by specifying or calculating positions and orientations get a default configuration value (0,0,0,0), which might not be valid for reaching the target.

Common problems related to robot axis configurations

It is most likely that targets created by other ways than jogging cannot be reached at their default configuration.

Even if all targets in a path have reachable configurations, you might encounter problems when running the path if the robot cannot move from one configuration to the other. This is likely to occur where an axis shifts greater than 90 degrees during linear or circular movements.

Common solutions for configuration problems

To resolve the problems described above, you can assign a valid configuration to each target and verify that the robot can move along each path. You can also turn configuration control off, which means that you ignore the stored configurations and let the robot find working configurations at runtime. If this is not done the proper way, you might get unexpected results.

In some cases there might not be any working configurations. Possible solutions might then be to reposition the work piece, reorient targets (if acceptable for the process) or add an external axis that either moves the work piece or the robot for increasing reachability.

Continues on next page

1 Introduction to RobotStudio

1.2.7 Robot axis configurations

Continued

How configurations are denoted

The robot's axis configurations are denoted by a series of four integers, specifying in which quadrant of a full revolution significant axes are located. The quadrants are numbered from zero for positive (counterclockwise) rotation and from -1 for negative (clockwise) rotation.

For a linear axis, the integer specifies the range (in meters) from the neutral position in which the axis is located.

A configuration for a six-axis industrial robot (like IRB 140) may look like:

```
[ 0-121 ]
```

The first integer (0) specifies the position of axis 1: somewhere in the first positive quadrant (between 0 and 90 degrees rotation).

The second integer (-1) specifies the position of axis 4: somewhere in the first negative quadrant (between 0 and -90 degrees rotation).

The third integer (2) specifies the position of axis 6: somewhere in the third positive quadrant (between 180 and 270 degrees rotation).

The fourth integer (1) specifies the position of axis x, a virtual axis used for specifying the wrist center in relation to other axes.

Configuration control

When executing a robot program, you can choose whether to control configuration values. If configuration control is turned off, configuration values stored with the targets are ignored, and the robot will use the configuration closest its current configuration for reaching the target. If turned on, it will only use the specified configuration for reaching the targets.

Configuration control can be turned off and on for joint and linear movements independently and is controlled by the ConfJ and ConfL action instructions.

Turning configuration control off

Running a program without configuration control may result in different configurations each time a cycle is executed: When the robot returns to the start position after completing a cycle, it may choose a different configuration than the original.

For programs with linear move instructions this might cause a situation where the robot gets closer and closer its joint limits and eventually will not be able to reach the target.

For programs with joint move instructions this might cause sweeping, unpredictable movements.

Turning configuration control on

Running a program with configuration control forces the robot to use the configurations stored with the targets. This results in predictable cycles and predictable motions. In some situations, however, like when the robot moves to a target from an unknown position, using configuration control may limit the robot's reachability.

When programming offline, you must assign a configuration to each target if the program shall be executed with configuration control.

1.2.8 Libraries, geometries and CAD files

Overview

For programming or simulating in RobotStudio, you need models of your work pieces and equipment. Models for some standard equipment are installed as libraries or geometries with RobotStudio. If you have CAD models of your work pieces and custom equipment, these can be imported as geometries to RobotStudio. If you do not have CAD models, you can create them in RobotStudio.

Difference between geometries and libraries

The objects you import to a station can be either geometries or libraries.

Geometries are basically CAD files, which, when imported, are copied to the RobotStudio station.

Libraries are objects that have been saved in RobotStudio as external files. When you import a library, a link from the station to the library file is created. Accordingly, the station file does not grow in the same way as when importing geometries.

Furthermore, besides the geometrical data, library files can contain RobotStudio-specific data. For example, if a tool is saved as a library, the tool data is saved together with the CAD data.

How geometries are constructed

An imported geometry is displayed as one part in the Layout browser. From RobotStudio's Modeling tab, you can see the components of the geometry.

The top node of the geometry is called a **Part**. The part contains **Bodies**, which can be of the types solid, surface or curve.

Solid bodies are 3D objects, made up of **Faces**. You recognize a true 3D solid by this one body containing multiple faces.

Surface bodies are 2D objects of just one face. A part that contains several bodies with one face each that together constitute a 3D object is created from 2D surfaces, and is therefore not a true 3D solid. If these parts are not created correctly, they might cause problems both in their display and graphical programming. see [Troubleshooting and optimizing geometries on page 94](#).

Curved bodies, represented by the body node alone in the Layout browser, do not contain any child nodes.

From the Modeling tab, you can edit the parts by adding, moving, rearranging or deleting bodies. Thus, you can optimize existing parts by removing unnecessary bodies, as well as create new parts by grouping bodies.

Continues on next page

1 Introduction to RobotStudio

1.2.8 Libraries, geometries and CAD files

Continued

Importing and converting CAD files

For importing geometries from single CAD files, you use RobotStudio's import function, see [Importing a station component on page 92](#).



Note

RobotStudio retains assembly structures in the imported CAD part. For parts with many entities, the import may take long. To workaround this problem, in the Home tab, click **Import Geometry** and then select **Convert CAD geometry to single part**.

Supported 3D formats

The native 3D CAD format of RobotStudio is SAT. The CAD support in RobotStudio is provided by the software component ACIS release 2017 1.0.

RobotStudio also supports other formats for which you need an option. The following table shows the supported formats and the corresponding options:

Format	File extensions	Option required
3DStudio	.3ds	-
ACIS, reads versions R1 - 2017 1.0, writes versions R18 - 2017 1.0	.sat, .sab, .asat, .asab	-
CATIA V4, reads versions 4.1.9 to 4.2.4*	.model, .exp, .session	CATIA V4
CATIA V5/V6, reads versions V5R8 – V5/V6R2016 writes V5R15 – V5/V6R2016*	.CATPart, .CATProduct, .CGR, .3DXML	CATIA V5
COLLADA 1.4.1	.dae	-
DirectX writes 2.0	.x	-
DXF/DWG, reads versions 2.5 - 2016*	.dxf, .dwg	AutoCAD
FBX writes version 7.5	.fbx	-
IGES, reads up to version 5.3, writes version 5.3*	.igs, .iges	IGES
Inventor, reads V6 – 2016*	.ipt, .iam	Inventor
JT, reads versions 8.x and 9.x*	.jt	JT
LDraw, reads version 1.0.2	.ldr, .ldraw, .mpd	-
NX, reads versions NX 1 – NX 10*	.prt	NX
OBJ	.obj	-
Parasolid, reads versions 9.0.* – 29.0.*	.x_t, .xmt_txt, .x_b, .xmt_bin	Parasolid
Pro/E / Creo, reads versions 16 – Creo 3.0*	.prt, .prt.*, .asm, .asm.*	Pro/ENGINEER

Continues on next page

Format	File extensions	Option required
Solid Edge, reads versions V18 – ST8*	.par, .asm, .psm	SolidEdge
SolidWorks, reads versions 2003 – 2016*	.sldprt, .sldasm	SolidWorks
STEP, reads versions AP203, AP214, AP242, writes version AP214*	stp, step, p21	STEP
STL, ASCII STL supported (binary STL not supported)	stl	-
VDA-FS, reads 1.0 and 2.0, writes 2.0*	vda, vdafs	VDA-FS
VRML, reads VRML2 (VRML1 not supported)	wrl, vrml, vrml2	-

* Supported only in the 64-bit version of RobotStudio.

To import these files into RobotStudio, use the **Import Geometry** function.

Mathematical versus graphical geometries

A geometry in a CAD file always has an underlying mathematical representation. Its graphical representation, displayed in the graphics window, is generated from the mathematical representation when the geometry is imported to RobotStudio, after which the geometry is referred to as a part.

For this kind of geometry, you can set the detail level of the graphical representation, thus reducing the file size and rendering time for large models and improving the visual display for small models you might want to zoom in on. The detail level only affects the visual display; paths and curves created from the model will be accurate both with coarse and fine settings.

A part can also be imported from a file that simply defines its graphical representation; in this case, there is no underlying mathematical representation. Some of the functions in RobotStudio, such as snap mode and creation of curves from the geometry, will not work with this kind of part.

To customize the detail level settings, see [Options on page 217](#).

1 Introduction to RobotStudio

1.3.1 Installation options and prerequisites

1.3 Installing and licensing RobotStudio

1.3.1 Installation options and prerequisites

Prerequisites

You should have administrator privileges on the PC before installing RobotStudio.

Installation options

You can download RobotStudio from <http://new.abb.com/products/robotics/robotstudio/downloads>, and install it.

RobotStudio offers the following installation options:

- **Minimal** - Installs only the features required to program, configure, and monitor a real controller connected over Ethernet.
- **Complete** - Installs all the features required to run the complete RobotStudio. If installed with this option, additional features of Basic and Premium functionality are available.
- **Custom** - Installs user-customized features. This option allows excluding unwanted robot libraries.



Note

Both the 32 and 64-bit versions of RobotStudio are installed for the Complete installation option on computers that have a 64-bit operating system. The 64-bit edition allows large CAD-models to be imported as it can address more memory than the 32-bit version.

However, the 64-bit edition has the following limitations:

- ScreenMaker and Integrated Vision are not supported.
- Add-ins will be loaded from the following folder

```
C:\Program Files (x86)\ABB Industrial IT\Robotics  
IT\RobotStudio 6.04\Bin64\Addins
```

Installing RobotWare

A matching RobotWare version will be installed with RobotStudio. You can download and install additional RobotWare versions through RobotStudio when connected to the Internet. In the **Add-Ins** tab, click **RobotApps**. The RobotWare section shows the RobotWare versions available for downloading.

1.3.2 Activating RobotStudio

RobotStudio feature levels

RobotStudio is categorized into the following two feature levels:

- **Basic** - Offers selected RobotStudio functionality to configure, program, and run a virtual controller. It also includes online features for programming, configuring, and monitoring a real controller connected over Ethernet.
- **Premium** - Offers full RobotStudio functionality for offline programming and simulation of multiple robots. The Premium level includes the features of the Basic level and requires activation. To purchase a Premium license, contact your local ABB Robotics sales representative at www.abb.com/contacts.

The following table lists the features provided with Basic and Premium licenses.

Feature	Basic	Premium
Necessary features for commissioning a real or virtual robot ¹ , such as: <ul style="list-style-type: none"> • System Builder • Event Log Viewer • Configuration Editor • RAPID Editor • Backup / Restore • I/O Window 	Yes	Yes
Productivity features, such as: <ul style="list-style-type: none"> • RAPID Data Editor • RAPID Compare • Adjust robtargets • RAPID Watch • RAPID Breakpoints • Signal Analyzer • MultiMove tool • ScreenMaker^{1,2} • Jobs 		Yes
Elementary offline features, such as: <ul style="list-style-type: none"> • Open station • Unpack & Work • Run Simulation • Go Offline • Robot jogging tools • Gearbox heat prediction • ABB Library of robots 	Yes	Yes
Advanced offline features, such as: <ul style="list-style-type: none"> • Graphical programming • Save station • Pack & Go • Import / Export Geometry • Import Library • Create station viewer and movies • Transfer • AutoPath • 3D operations 		Yes

Continues on next page

1 Introduction to RobotStudio

1.3.2 Activating RobotStudio

Continued

Feature	Basic	Premium
Add-Ins		Yes
1. Requires the RobotWare option PC Interface on the real robot controller system to enable LAN communication. The option is not needed for connection via the Service port or for virtual controller communication.		
2. Requires the RobotWare option FlexPendant Interface on the robot controller system		

In addition to the Premium functionality, add-ins like PowerPacs is also available.

- PowerPacs provide enhanced features for selected applications.

Activating RobotStudio

The activation procedures are different for standalone and network licenses. If you have a standalone license, refer [Activating a standalone license on page 46](#) and if you have a network license, refer [Activating a network license on page 47](#).



Note

If you accidentally activate a network license through the standalone activation procedure, the license becomes invalid. You must contact ABB for support.

Activating a standalone license

Standalone licenses are activated through the Activation Wizard. If your computer has Internet access, RobotStudio gets activated automatically, otherwise manual activation is required.

Use the following steps to start the Activation Wizard.

- 1 Click the **File** tab, and then click the **Help** section.
- 2 Under **Support**, click **Manage Licenses**. The **Options** dialog appears with the **Licensing** options.
- 3 Under **Licensing**, click **Activation Wizard** to view RobotStudio license options.



Note

To resolve issues during activation, contact your local ABB customer support representative at the e-mail address or telephone number provided at www.abb.com/contacts. Alternatively, with your activation key attached, send an e-mail to softwarefactory_support@se.abb.com.

With Internet access

When your computer is connected to Internet, the Activation Wizard automatically sends your activation request to the ABB licensing servers. Your license will then be automatically installed and your product will be ready for use. RobotStudio must be restarted after activation.

Without Internet access

If your computer is not connected to Internet, you must proceed with manual activation.

- 1 Create a license request file by selecting the option **Step 1:Create a license request file**.

Continues on next page

Proceed through the wizard, enter your activation key and save the license request file to your computer.

- 2 Use removable storage, such as a USB stick, to transfer the file to a computer with an Internet connection. On that computer, open a web browser, go to <http://manualactivation.e.abb.com/> and follow the instructions given.

The result will be a license key file that should be saved and transferred back to the computer having the installation awaiting activation.

- 3 Relaunch the activation wizard and go through the steps until you reach the *Activate a Standalone License* page.

- 4 Under *Manual Activation*, select the option **Step 3:Install a license file**.

Proceed through the wizard, selecting the license key file when requested.

Upon completion, RobotStudio is activated and ready for use.

RobotStudio must be restarted after the activation.

Activating a network license

Network licensing allows you to centralize license management by installing licenses on a single server rather than on each individual client machine. The server administers the licenses to the clients as required. A single network license allows several clients to use the software.

Network Licensing is set up in the following stages:

- 1 Install the server for network licensing (See [Installing the Network Licensing Server on page 47](#))
- 2 Activate the licenses for network licensing (See [Using the SLP Server Web Interface on page 48](#))
- 3 Set up the client for network licensing (See [Setting up Network Licensing in the client on page 50](#))



Tip

Network licenses are displayed as *Network* in the **View Installed Licenses** link of the Licensing page.

Installing the Network Licensing Server

Network licensing in RobotStudio uses the SLP Distributor server as the network licensing server. It manages the allocation of network licenses to the clients.

You can install the SLP Distributor server from the Utilities\SLP Distributor directory of the RobotStudio distribution.



Note

You need administrative privileges for installing and configuring the SLP Distribution server. The installer requires the following details:

- Windows Server 2012 or 2008, Windows 8, Windows 7, or Windows Vista
- .NET Framework 3.5 SP1

Continues on next page

1 Introduction to RobotStudio

1.3.2 Activating RobotStudio

Continued

The SLP Distributor server is installed as a service that starts automatically with Windows. It requires two open TCP ports, by default 2468 (for the web interface) and 8731 (for licensing). The installer opens these ports in the standard Windows Firewall, but any third-party firewall must be configured manually by the system administrator.

Using the SLP Server Web Interface

Once the SLP server is online, you can access its web interface on the address *http://<server>:2468/web*.

The following table shows how to use the server's web interface.

To...	Use...
Activate a network license automatically (for PCs with Internet connection)	<p>The Activation tab.</p> <p>Type in the Activation Key provided by ABB, and then click Submit.</p> <p>The number of concurrent users activated depends on the activation key provided.</p>  <p>xx1300000052</p>

Continues on next page

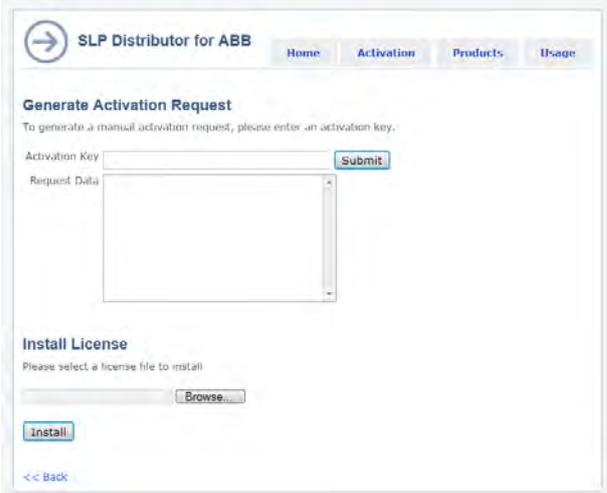
To...	Use...
<p>Activate a network license manually (for PCs <i>without</i> Internet connection)</p>	<p>The Activation tab.</p> <ol style="list-style-type: none"> 1 Click Manual Activation. 2 Type in your activation key provided by ABB, and then click Submit. 3 Save the file to a removable storage, such as a USB stick, then transfer the file to a machine with an Internet connection. On that machine, open a web browser and browse to http://manualactivation.e.abb.com/ and follow the instructions given. A license key file will be generated and saved and will be returned to the machine which hosts the installation. 4 Once you receive the license file, click Browse to upload and install the license file. <p>Your network license is now activated.</p>  <p>xx130000051</p>
<p>View the installed licenses</p>	<p>In the Home tab, under Dashboard, click Details. Alternatively, click the Products tab. The Product details for RobotStudio page opens which shows the installed licenses details.</p>
<p>View the usage of licenses</p>	<p>In the Home tab, under Dashboard, click Usage. Alternatively, click the Usage tab. The <i>Current usage of RobotStudio</i> page opens in which the following details are tabulated.</p> <ul style="list-style-type: none"> • Licenses which are currently allocated • Client to which each license is allocated to • Number of remaining licenses available for use <p>Each table row corresponds to one client system.</p>

Continues on next page

1 Introduction to RobotStudio

1.3.2 Activating RobotStudio

Continued



Note

Certain proxy issues upon activation in the web interface of SLP server may produce a message which only states *Activation failed*. This issue happens when the system account that executes *SLP-Distributor-service* does not have the rights to read the user profile. As a workaround, follow this procedure:

- 1 Open the **Services** control panel (services.msc)
- 2 Open properties for **Software Potential Distributor**
- 3 Change **Log on as** to an actual named user, preferably the currently logged on user
- 4 Restart the service and re-attempt an activation.
- 5 After your re-attempt, change **Log on as** back to Local System account and restart the service.

Setting up Network Licensing in the client



Note

You require Administrative privileges to store this configuration.

You need to use the RobotStudio Activation Wizard in the client system for setting up Network Licensing.

Use this procedure to set up Network Licensing for a client system.

Action
1 On the File tab, click Options and go to General:Licensing .
2 On the Licensing page to the right, click Activation wizard to launch the Activation Wizard.
3 In the Activation Wizard, on the <i>Activate RobotStudio</i> page, choose the option I want to specify a network license server and manage server license , and then click Next . You will proceed to the <i>License Server</i> page.
4 Specify the name or IP address of the License Server, and then click Finish . If Windows UAC is enabled, a confirmation dialog appears. This prompts you to restart RobotStudio in order to start using the specified server. To go to the SLP Distributor server web interface, click the Open the server dashboard link. For information about using the server dashboard, see Using the SLP Server Web Interface on page 48 . Note that the changes made are not applied until RobotStudio is restarted.



Note

For Network Licensing to work, the client system should be online with the server. For information about enabling licensing while working offline, see [Using Commuter Licenses on page 51](#).

Continues on next page

Using Commuter Licenses

Commuter licenses allow a client system to work offline from the license server. You can check out a license from the server for a specified number of days. During this period the checked out license is unavailable to other users. The commuter license is made available for other clients only when it is manually checked in back to the server.

The commuter license in the client system expires when the check out time expires. In this case, on starting RobotStudio in the client system, the Network License dialog opens automatically and prompts you to check in the license back to the server.

**Note**

It is not possible to check out specific features in the license. All features in a license are included when it is checked out.

To check in/check out a commuter license, you need to use the Activation Wizard. Use this procedure to check in/check out a commuter license.

	Action
1	On the File menu, click Options and select General: Licensing
2	On the Licensing page to the right, click Activation wizard to launch the Activation Wizard.
3	In the Activation Wizard, on the <i>Activate RobotStudio</i> page, choose I want to check out or check in a commuter license and click Next . You will proceed to the <i>Commuter License</i> page.
4	Under <i>Commuter License</i> , you will be presented one of the following options as per your requirement: <ul style="list-style-type: none"> • Check out a commuter license - In the Check out days box specify the specify the number of days for which you wish to keep the license. This option is disabled if you already have a commuter license checked out. • Check in a commuter license - Choose this option to return the currently checked out license to the server. This option is enabled only if a commuter license is already checked out. If so, the expiration date and time of the license is also displayed.
5	Click Finish to complete the check in/check out.

**Tip**

Network licenses that are checked-out as commuter licenses will be displayed as Floating (checked out) in the *View Installed Licenses* link of the Licensing page.

1 Introduction to RobotStudio

1.4.1 Ribbon, tabs and groups

1.4 User interface

1.4.1 Ribbon, tabs and groups

The following figure shows the ribbon, tabs and groups of the Graphical User Interface.

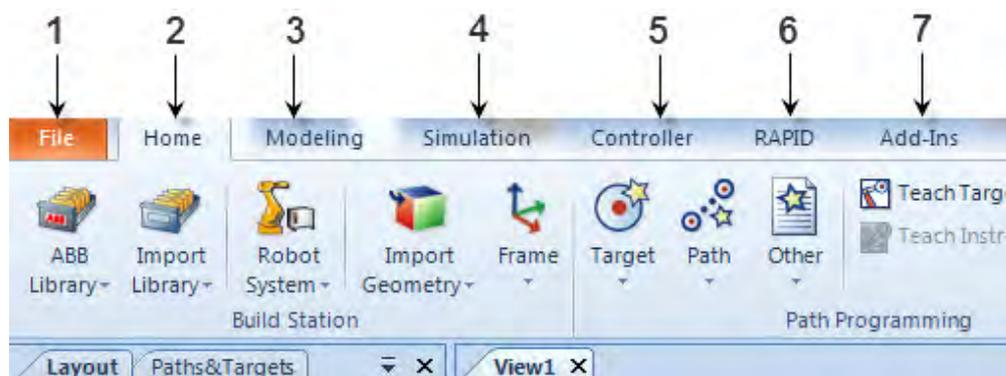

en090000215

	Tab	Description
1	File	Contains the options to create new station, create new robot system, connect to a controller, save station as viewer, and RobotStudio options. For more information, see File tab on page 209 .
2	Home	Contains the controls required for building stations, creating systems, programming paths and placing items. For more information, see Home tab on page 225 .
3	Modeling	Contains the controls for creating and grouping components, creating bodies, measurements and CAD operations. For more information, see Modeling tab on page 281 .
4	Simulation	Contains the controls for setting up, configuring, controlling, monitoring and recording simulations. For more information, see Simulation tab on page 351 .
5	Controller	Contains the controls for synchronization, configuration and tasks assigned to the Virtual Controller (VC). It also contains the controls for managing the real controller. For more information, see Controller tab on page 381 .
6	RAPID	Contains the integrated RAPID editor, used for editing all robot tasks other than robot motion. For more information, see RAPID tab on page 445 .
7	Add-Ins	Contains the control for PowerPacs . For more information, see Add-Ins tab on page 477 .

1.4.2 Layout browser

Overview

The layout browser is a hierarchical display of physical items, such as robots and tools.

Icons

Icon	Node	Description
 xx050000	Robot	The robot in the station.
 xx050001	Tool	A tool.
 xx050002	Link collection	Contains all the links of the objects.
 xx050003	Link	A physical object in a joint connection. Each link is made up of one or several parts.
 xx050004	Frames	Contains all the frames for an object.
 xx050005	Component group	A grouping of parts or other assemblies, carrying its own coordinate systems. It is used to structure a station.
 xx050006	Part	A physical object in RobotStudio. Parts with geometric information are made up of one or more 2D or 3D entities. Parts without geometric information (such as imported .jt files) are empty.
 xx050007	Collision set	Contains all collision sets. Each collision set includes two groups of objects.
 xx050008	Objects group	Contains references to the objects that are subject to collision detection.
 xx050009	Collision set mechanisms	The objects in the collision set.
 xx050010	Frame	The frames in the station.

1 Introduction to RobotStudio

1.4.3 The Paths & Targets browser

1.4.3 The Paths & Targets browser

Overview

The paths & targets browser is a hierarchical display of non-physical items.

Icons

Icon	Node	Description
 xx050011	Station	Your station in RobotStudio.
 xx050012	Virtual controller	The system for controlling the robots, just like a real IRC5 controller.
 xx050013	Task	Contains all logical elements in the station, such as targets, paths, workobjects, tooldata and instructions.
 xx0500001376	Tooldata Collection	Contains all tooldata.
 xx050014	Tooldata	A tooldata for a robot or a task.
 xx050015	Workobjects & Targets	Contains all workobjects and targets for the task or robot.
 xx050016	Jointtarget Collection and Jointtarget	A specified position of the robot axes.
 xx050017	Workobject Collection and Workobject	The workobject collection node and the workobjects it contains.
 xx050018	Target	A defined position and rotation for a robot. A target equals a RobTarget in a RAPID program.
 xx050021	Path Collection	Contains all paths in the station.
 xx050022	Path	Contains the instructions for the robot movements.
 xx050023	Linear Move Instruction	A linear TCP motion to a target. If the target has no valid configuration assigned, the move instruction gets the same warning symbols as the target.
 xx050024	Joint Move Instruction	A joint motion to a target. If the target has no valid configuration assigned, the move instruction gets the same warning symbols as the target.
 xx050025	Action Instruction	Defines an action for the robot to perform at a specified location in a path.

1.4.4 The Controller browser

Overview

The Controller browser is a hierarchical display of controller and configuration elements found in the Controller tab view.

Icons

Icon	Node	Description
 control	Controllers	Contains the controllers that are connected to the Robot View.
 control0	Connected Controller	Represents a controller with a working connection.
 control1	Connecting Controller	Represents a controller which is currently being connected.
 control2	Disconnected Controller	Represents a controller that has lost its connection. It might have been turned off or disconnected from the network.
 control3	Denied login	Represents a controller that denies you access to login. Possible reasons for denied access are: <ul style="list-style-type: none"> • User lacks necessary access privileges • Too many clients connected to the controller • The RobotWare version of the system running on the controller is newer than the RobotStudio version
 configu0	Configuration	Contains the configuration topics.
 configu1	Topic	Each parameter topic is represented by a node: <ul style="list-style-type: none"> • Communication • Controller • I/O • Man-machine communication • Motion
 eventrec	Event Log	With the Event Log, you can view and save controller events.
 io	I/O System	Represents the controller I/O system. The I/O system consists of industrial networks and units.
 io-node	Industrial Network	An industrial network is a connector for one or several devices.

Continues on next page

1 Introduction to RobotStudio

1.4.4 The Controller browser

Continued

 io-devic	Device	A device is a board, panel or any other device with ports through which the I/O signals are sent.
 rapid16t	RAPID Tasks	Contains the active tasks (programs) of the controller.
 prgintas	Task	A task is a robot program, which executes alone or together with other programs. A program is composed of a set of modules.
 xx1500000335	Program Modules	Program modules contain a set of data declarations and routines for a specific task. Program modules contain data specific to this task.
<u>System Modules</u>	System Modules	System modules contain a set of type definitions, data declarations and routines. System modules contain data that applies to the robot system, regardless of the program modules that are loaded.
 nostepin	Nostepin Module	A module that cannot be entered during step-by-step execution, that is, all instructions in the module are treated as one if the program is executed step-by-step.
 modules	View-only and Read-only Program Modules	An icon for program modules that are either view-only or read-only.
 module_e	View-only and Read-only System Modules	An icon for system modules that are either view-only or read-only.
 procedur	Procedure	A routine that does not return any value. Procedures are used as subprograms.
 function	Function	A routine that returns a value of a specific type.
 trap16tr	Trap	A routine that provides a means of responding to interrupts.

1.4.5 Files browser

Overview

The Files browser in the RAPID tab allows you to manage RAPID files and system backups. Using the Files browser you can access and then edit standalone RAPID modules and system parameter files that are not residing in the controller memory.

Icons

Icon	Node	Description
 xx1200000824	Files	See Managing RAPID files on page 458 .
 xx1200000825	Backups	See Managing system backups on page 458 .

1 Introduction to RobotStudio

1.4.6 Add-Ins browser

1.4.6 Add-Ins browser

Overview

The Add-Ins browser shows the installed PowerPacs, General add-ins , if available, under their respective nodes.

Icons

Icon	Node	Description
 xx1200000826	Add-In	Indicates an available add-in loaded into the system
 xx1200000827	Disabled Add-In	Indicates a disabled add-in
 xx1200000828	Unloaded Add-In	Indicates an add-in un-loaded from the system

1.4.7 Windows layout

Overview

RobotStudio has a set of predefined window layouts. These layouts determine the size and location of the four main windows, Layout, Paths&Targets, Tags and Output. These windows are enabled by default and can be shown or hidden by the **Windows** menu.

You can access the Windows menu from **Customize Quick Access Toolbar > Windows Layout > Windows**.

Windows layout options

The Windows Layout menu provides the following options:

Select this option	To..
Minimize the Ribbon	Reduce the size of the ribbon.
Default Layout	Set window layouts to default settings.
Windows	To enable or disable the window layouts(Layout, Paths&Targets, Tags and Output).



Note

The **Default Layout** option does not work for Windows that RobotStudio Add-Ins and PowerPacs add. However, the individual windows can be shown or hidden by the **Windows** menu.

1 Introduction to RobotStudio

1.4.8 The Output window

1.4.8 The Output window

Overview

The output window displays information about events that occur in the station, such as when simulations are started or stopped. This information is useful when troubleshooting stations.

Layout of the Output tab

The **Output** tab contains two columns: the first states the event, the second the time the message was generated. Each row is a message.

Event types

The three event types indicate the severity of the event:

Event type	Description
Information	An information message is a normal system event, for example, starting and stopping programs, changing the operational mode, and turning motors on and off. Information messages never require an action from you. They can be useful for tracking errors, collecting statistics or monitoring user-triggered event routines.
Warning	A warning is an event of which you should be aware, but it is not so severe that the process or RAPID program needs to be stopped. Warnings must occasionally be acknowledged. Warnings often indicate underlying problems that at some point will need to be resolved.
Error	An error is an event that prevents the robot system from proceeding. The running process or RAPID program cannot continue and will be stopped. An error must occasionally be acknowledged. Some errors require some immediate action from you in order to be resolved. Double-click an error to display a detailed information box.

Some of the events are active. These are linked to an action for resolving the problem that generated the event. To activate the linked action, double-click the message.

Handling messages in the Output window

Goal	Procedure
To filter messages...	Right-click in the Output window and then click Show messages . From the options All Errors , Information , Warnings and Warnings and Errors , select the type of messages you want to display.
To save a message to file...	Select it, right-click and then click Save to file . Choose a name and location in the dialog box. Multiple messages can be selected by pressing SHIFT while clicking each.
To clear the Output window...	Right-click in the Output window and then click Clear .

1.4.9 The Controller Status window

Overview

The Controller Status window shows the operational status of the controllers in your robot view.

Layout of the Controller Status window

The Controller Status window has the following columns:

- 1 **System Name** : Displays the name of the system running on the controller.
- 2 **Controller Name** : Displays the name of the controller.
- 3 **Controller State** : Displays the state of the controller.

When the controller is in state...	the robot is...
Initializing	starting up. It will shift to state <i>motors off</i> when it has started.
Motors off	in a standby state where there is no power to the robot's motors. The state has to be shifted to motors on before the robot can move.
Motors on	ready to move, either by jogging or by running programs.
Guard Stop	stopped because the safety runchain is opened. For instance, a door to the robot's cell might be open.
Emergency Stop	stopped because emergency stop was activated.
Waiting for motors on after e-stop	ready to leave emergency stop state. The emergency stop is no longer activated, but the state transition isn't yet confirmed.
System Failure	in a system failure state. Restart required.

- 4 **Program Execution State** : Displays if the robot is running any program or not.

When the controller is in state...	the robot...
Running	is running a program.  Note A Job will not be executed in this state.
Ready	has a program loaded and is ready to run it when a PP (starting point in the program) has been set.
Stopped	has a program loaded, with a PP, and is ready to run it.
Uninitialized	has not initialized the program memory. This indicates an error condition.

- 5 **Operating Mode** : Displays the operating mode of the controller.

When the controller is in mode...	the robot is...
Initializing	starting up. It will shift to the mode selected on the controllers cabinet when it has started.

Continues on next page

1 Introduction to RobotStudio

1.4.9 The Controller Status window

Continued

When the controller is in mode...	the robot is...
Auto	ready to run programs in production. In Auto mode it is possible to get remote Write access to the controller, which is necessary for editing programs, configurations and other things when connected to a real controller.
Manual	only able to move if the three-position enabling device on the FlexPendant is activated. Furthermore, the robot can only moved with reduced speed in manual mode. In manual mode it is not possible to get remote Write access to the controller, unless it is configured for this and the remote Write access granted on the FlexPendant.
Manual full speed	only able to move if the three-position enabling device on the FlexPendant is activated. In manual mode it is not possible to get remote Write access to the controller, unless it is configured for this and the remote Write access granted on the FlexPendant.
Waiting for acknowledge	about to enter Auto mode, but the mode transition has not yet been acknowledged.

- 6 **Logged on as:** Displays the user name the PC is logged on to the controller with.
- 7 **Access :** Displays the users having write access to the controller, or if it is available.

1.4.10 The Operator Window

Overview

Operator Window is an alternative to the corresponding feature in the Virtual FlexPendant for communicating with the user during RAPID program execution. It displays the same output as displayed on the Virtual FlexPendant Operator Window.

When running in a Virtual Controller, the RAPID program communicates with the operator via messages on the FlexPendant screen. The Operator Window integrates this functionality and allows the user to run interactive RAPID programs without starting the Virtual FlexPendant.



Note

The Operator window starts when a Virtual Controller starts. The Virtual Controller starts while opening a station or when adding a system.

Enabling Operator Window

To enable an operator window:

- 1 On the **File** menu, click **Options**.
- 2 On the Navigation pane to the left, select **Robotics:Virtual Controller**.
- 3 On the **Virtual Controller** page to the right, select **Automatically open virtual Operator Window**.
- 4 Click **Apply**.



Note

When the **Show virtual Operator Window** feature is enabled, an Operator Window is automatically created for each controller in the station. By default, the window is located in the tab area below the graphics window.

RAPID Instructions

The following are the RAPID instructions supported by the Operator Window. When these instructions are executed, the behavior is similar to that of Virtual FlexPendant:

- TPErase
- TPReadFK
- TPReadNum
- TPWrite
- UIAlphaEntry
- UIMsgBox
- UINumEntry

Continues on next page

The following are the RAPID instructions not supported by the Operator Window. When these instructions are executed, an error message is displayed in the Operator Window prompting you to use the Virtual Flexpendant instead:

- TPSHow
- UISHow
- UINumTune
- UListView

The controller switches to automatic mode when UISHow is executed.



Note

You should not run both the Virtual Flexpendant and Operator Window simultaneously. RobotStudio will automatically request mastership when committing data to the controller, when actions are taken in Virtual Operator Window. This can cause undesired effect when using the Virtual FlexPendant at the same time.

The emergency stop button pressed on the Virtual FlexPendant cannot be reset through the virtual controller control panel. You must reset this button on the Virtual FlexPendant.

1.4.11 The Documents window

Overview

The Documents window allows you to search and browse the RobotStudio documents like libraries, geometry and so on in large numbers and from different locations. You can also add associate documents with a station, either as a link or by embedding a file in the station.

Opening a Documents window

- 1 On the **Home** tab, click **Import Library** and select **Documents** from the dropdown menu.

The **Documents** window appears.

Layout of the Documents window

The Documents window is a docked area that by default takes the right-hand corner. The upper part of the window contains controls for searching and browsing the document locations. The lower part consists of a list view that displays the documents and folders and a status area.

Control	Description
Station Search	Allows to add documents associated with the station, either by adding the file/folder as a reference (link) or by embedding the file in the station. See Using the Station mode on page 65 .
Search	Allows to search for keywords or query. See Using the Search mode on page 66 .
Browse	Displays a folder structure of the document locations. See Using the Browse mode on page 68 .
Location	Allows to configure the document location. See Document Locations window on page 70 .

Using the Station mode

Use this procedure to add documents associated with the current station:

- 1 Click **Station** from the Document Manager.
- 2 Click **Add** button and select what to add to the current station:
 - File Reference
 - Folder Reference
 - Embedded File
 - New Text Document



Note

- The referenced file/folder is displayed with an arrow icon
- The embedded file and new text document are displayed with a diskette icon

- 3 In the Documents window, right-click the document.

Continues on next page

1 Introduction to RobotStudio

1.4.11 The Documents window

Continued

The following context menu items appear depending on the document type selected:

Item	Description
Open	Opens the document in the program associated with its file type. For example, a <i>.docx</i> file is opened in Microsoft Word. An embedded file is saved to a temporary location before opening. If RobotStudio detects that the temporary file has changed, you will be asked to update the embedded file.
Open containing folder	Opens the folder containing the file in Windows Explorer. This option is not available in embedded files.
Copy to Station	Converts a referenced file to an embedded file.
Save as	Saves an embedded file to disk.
Include in Pack and Go	Specifies if a referenced file/folder should be included when a <i>Pack and Go</i> file is created. For a referenced folder, all files in the folder will be included. To use this option, the file must be located in the parent folder of the station file. For example, if the station file is <i>D:\Documents\Stations\My.rsstn</i> , the reference must be located in <i>D:\Documents</i> to be included in <i>Pack and Go</i> . Embedded files are always included when a <i>Pack and Go</i> file is created, since they are part of the station file.
Include Subfolders	Specifies that subfolders of a referenced folder should be included in <i>Pack and Go</i> .
Remove	Removes the selected document.



Note

Some context menu items can be disabled and the document marked as *Locked* in the API.

Using the Search mode

- 1 Click the option **Search** and enter a query or syntax in the text box.

For more information about the available syntaxes, see [Search syntax on page 67](#).



Note

The drop-down list contains the search history of the previous ten queries between sessions.

- 2 Click the **Expand** button to access additional controls.

This allows you to specify if the search should cover all the enabled locations or one specific location.

Continues on next page

- 3 Select **Search in results** check box to search for the resulting documents of the previous search.

**Note**

The search is performed automatically, after you stop typing in the text box or manually, by clicking the glass icon. During the search, this icon is changed to a cross and clicking this cancels the search operation.

Search syntax

The search field supports certain keywords and operators which allows you to specify an advanced search query.

**Note**

Keywords are not localised.

The following table displays the keywords that specifies an advanced search query:

Keywords	Description
filename	matches the filename of the documents.
title	matches the title field of the document metadata.
type	matches the type field of the document metadata. For library (.rslib) files, this is a user-defined string. For example, Robot. For other files, this is the Windows description of the file type. For example, Text Document.
author	matches the author field of the document metadata.
comments	matches the comment field of the document metadata.
revision	matches the revision field of the document metadata.
date	matches the last time the file was modified. For the colon operator, the match is done against a string representation of the modified date. For other operators, the search string should interpret as a date according to .NET standards.
size	matches the file size (in KB).
and, or, parentheses (), not	used to group or invert queries.

The following table displays the operators that specifies an advanced search query

Operator	Description
:	matches if the field contains the search string.
=	matches if the field equals the search string.
<	matches if the field is smaller than the search string.
>	matches if the field is greater than the search string.

Continues on next page

1 Introduction to RobotStudio

1.4.11 The Documents window

Continued



Note

- Quotation marks can be used to specify a string with whitespace. An empty string is specified by "".
- All search strings are case insensitive.
- Text without a preceding keyword is matched against the filename and all metadata.
- If queries are specified without a grouping keyword, "and" is implied.
- Some metadata (title, author, comments and revision) is not available for all file types.

Examples

- **1400** - Matches documents with the string 1400 in the filename or any metadata.
- **not author:ABB** - Matches documents where the author field does not contain the string ABB.
- **size>1000 and date<1/2009** - Matches documents larger than 1000KB and modified before 1/1/2009.
- **IRBP comments="ABB Internal"** - Matches documents with the string IRBP in the filename or any metadata, and where the comment field equals ABB Internal.

Using the Browse mode

- 1 Click the option **Browse** from the Document Manager.
A folder structure of the document location is displayed.



Note

The top level of the folder structure lists the configured locations. If a location is unavailable (for example, an offline network path) it is marked as **Unavailable** and cannot be opened. The text box displays the path of the current folder relative to the location root.

- 2 You can open a folder in either of the two ways:
 - Double-click the document location.
 - Right-click the document location and select **Open** from the context menu.
- 3 You can navigate through the folders in either of the two ways:
 - Click the folder icon at the top-right corner.
 - Select the parent folder from the dropdown list.



Note

You can browse and add component xml files (*.rsxml) to your station.

Continues on next page

- 4 Click **Refresh** icon in the text box to manually refresh the contents of the folder.

**Note**

The refresh operation can be time consuming, if a folder resides in a network location or contains many documents. During this time, the refresh icon changes to a cross icon allowing you to cancel the operation.

Results view

In the Browse mode, items are grouped into folders and documents. The resulting folders and documents are displayed in a list view.

The search result appears in the status bar at the bottom, displaying the number of items found, and progress made during the search. The Search results are grouped beneath headers according to their location.

Each document is represented by an image, the document title or filename in black text, and the metadata and file information in grey text. For library files, the image can be a screenshot or other custom image. For other document types, the image is the icon associated with the file type.

Using the Context menu

In the results view, right-click a document or folder. The following context menu items appears:

Item	Description
Open	This command opens the selected folder, library or geometry files, station files, and document. <ul style="list-style-type: none"> • For folders, browses into the selected folder. • For library or geometry files, imports the file into the station. (If no station is open ,a new empty station is first created.) • For station files, opens the station. • For other documents, attempts to open the selected document according to its file association. For example, Microsoft Word starts when a .doc file is opened.
Open containing folder	This command opens the folder containing the document or the folder in the Windows Explorer.
Properties	This command is disabled for folders. This command opens a dialog that displays complete metadata and file information about the selected document.

**Tip**

Double-click an item to import the library and geometry files and open the other documents.

Continues on next page

1 Introduction to RobotStudio

1.4.11 The Documents window

Continued

In the results view, right-click an empty area. The following context menu appears that controls how the documents are grouped and sorted:

Items	Description
Group by:	Controls how the documents are arranged in groups. The following options are available: <ul style="list-style-type: none">• Location• Folder• Type
Sort by:	Controls how the documents are sorted within the group. The following options are available: <ul style="list-style-type: none">• Name• Date• Size
Ascending and Descending	Items are sorted in the ascending and descending order.

Using the drag and drop feature

You can import a library or a geometry file into the station by dragging it from the results view into either the graphics window, or onto an object node in the Layout browser.

- When dragging into the Layout browser, the component will be placed as a child object under the station, component group or smart component.
- When dragging into the graphics window, the component will be positioned at the point on the station floor where you drop it. You can snap the point to the UCS grid by enabling the **Snap Grid** or by holding down the **ALT** key while dragging.

Document Locations window

You can launch the Document Locations window in any one of the following ways:

- 1 Select **Locations** from the **Documents** window.
- 2 On the **File** menu, click **Options** and select **Files & Folders** in the navigation pane. Click **Document Locations** on the right side.
- 3 On the **Home** tab, click **Import Library** and select **Locations** from the dropdown menu.

Layout of the Document Locations window

It consists of a menu bar and a list displaying the configured locations. The list displays general information about the locations. The menu bar contains the following controls:

Controls	Description
Locations	The following options are available from the dropdown menu: <ul style="list-style-type: none">• Import : Opens a dialog box to import document locations from an xml file. If a location with the same URL already exists, you have the option to retain or delete the existing location.• Export : Opens a dialog box to export all the configured locations to an xml file.• Reset to Default : Loads the default locations (ABB Library, User Library, and User Geometry).

Continues on next page

Controls	Description
Add Location	Opens a dialog box to add a document location. By default, there is one location type available. For more information, see File System location on page 71 .
Remove	Deletes the selected location.
Edit	Opens a dialog box to modify the selected location. For more information, see File System location on page 71 .

File System location

- 1 Click **Add Locations** and select **File System** from the dropdown menu. The **File System** dialog box appears.

The File System dialog box contains the following controls:

Control	Description
Location Name	Specifies a name associated with the location.
Path	Specifies the file system directory that corresponds to the root folder of the location. This can be on a local or network disk.
Filter	Specifies a filename filter to include only certain files when searching and browsing. Multiple filters are separated by a semicolon. If the filter is empty all files are included.
Cache files from network	Specifies that the library and geometry files from a network location should be copied to a local directory and imported from there, rather than directly from the network path. This will ensure that a station containing such files can be opened even if the network location is unavailable. This option is only available for network locations.
Directory	Specifies the directory where to store the local copies. This must be on a local disk.
Show as gallery	Specifies that the contents of the location should be displayed as a gallery in the specified ribbon menu.
Style	<ul style="list-style-type: none"> • Flat - Specifies that all documents are displayed in a single gallery with subfolder names as headers. • Recursive - Specifies that the documents are displayed in submenus corresponding to the folder structure.
Include when searching all locations	Specifies if the search should cover all the enabled locations.
Package (.rspak) installation source	<p>Select this check box to define a custom location for packages. You can access this package from the RobotApps window in the section as named in the Location Name box.</p> <p> Note</p> <p>You must close and re-open the RobotApps window for the changes to happen.</p>

1 Introduction to RobotStudio

1.4.12 Using a mouse

1.4.12 Using a mouse

Navigating the graphics window using the mouse

The table below shows how to navigate the graphics window using the mouse:

To	Use the keyboard /mouse combination	Description
Select items  selectio	 left-cl	Just click the item to select. To select multiple items, press CTRL key while clicking new items.
Rotate the station  rotate	CTRL + SHIFT +  left-cl	Press CTRL + SHIFT + the left mouse button while dragging the mouse to rotate the station. With a 3-button mouse you can use the middle and right buttons, instead of the keyboard combination.
Pan the station  pan	CTRL +  left-cl	Press CTRL + the left mouse button while dragging the mouse to pan the station.
Zoom the station  zoom	CTRL +  right-cl	Press CTRL + the right mouse button while dragging the mouse to the left to zoom out. Dragging to the right zooms in. With a 3-button mouse you can also use the middle button, instead of the keyboard combination.
Zoom using window  window_z	SHIFT +  right-cl	Press SHIFT + the right mouse button while dragging the mouse across the area to zoom into.
Select using window  window_s	SHIFT +  left-cl	Press SHIFT + the left mouse button while dragging the mouse across the area to select all items that match the current selection level.

1.4.13 3D Mouse

Overview

The 3Dconnexion 3D mouse has a pressure-sensitive controller cap designed to flex in all directions. Push, pull, twist, or tilt the cap to pan, zoom, and rotate the current view. A 3D mouse is used along with a regular mouse. Connecting a 3D mouse to your RobotStudio environment lets you to interact with the graphical environment.

You can connect the programmable buttons of the 3D mouse to your commonly used RobotStudio commands by assigning the commands to custom keyboard shortcuts. The custom keyboard shortcuts are configured with the same user interface as the Quick Access Toolbar. When the keyboard shortcuts are configured in RobotStudio, you must connect the programmable buttons to the keyboard shortcuts in the 3D mouse applications control panel. For more information, refer the user manual of the 3D mouse application.

Using a 3D mouse

The 3D mouse can move in six axes as mentioned in the following table.

Individual Axis	Axes	Description
 xx1500000297	Pan Right/Left	Moves the model right and left.
 xx1500000299	Zoom	Zoom the model in and out.
 xx1500000298	Pan Up/Down	Moves the model up and down.
 xx1500000301	Spin	Rotate around vertical axis.
 xx1500000300	Tilt	Tilts the model forwards and backwards.
 xx1500000302	Roll	Rolls the model sideways.

1.4.14 Selecting an item

Overview

Each item in a station can be moved to achieve the required layout, so you first have to determine its selection level. The selection level makes it possible to select only specific types of items, or specified parts of objects.

The selection levels are curve, surface, entity, part, mechanism, group, target/frame and path. The target/frame and path selection can be combined with any of the other selection levels.

Objects may also be grouped together as component groups, see [Component Group on page 282](#).

Selecting an item in the graphics window

To select items in the graphics window, follow these steps:

- 1 At the top of the graphics window, click the desired selection level icon.
 - 2 Optionally, click the desired snap mode icon for the part of the item you wish to select.
 - 3 In the graphics window, click the item. The selected item will be highlighted.
-

Multiple selection of items in the graphics window

To select multiple items in the graphics window, do the following:

- 1 Press the **SHIFT** key, and in the graphics window drag the mouse diagonally over the objects to select.
-

Selecting an item in the browsers

To select items in a browser, do the following:

- 1 Click the item. The selected item will be highlighted in the browser.
-

Multiple selection of items in the browsers

To select multiple items in a browser, follow these steps:

- 1 Make sure that all the items to be selected are of the same type and located in the same branch of the hierarchical structure; otherwise, the items will not be operable.
- 2 Do one of the following:
 - To select adjacent items: In the browser, hold down the **SHIFT** key and click the first and then the last item. The list of items will be highlighted.
 - To select separate items: In the browser, hold down the **CTRL** key and click the items you want to select. The items will be highlighted.

1.4.15 Attaching and detaching objects

Overview

You can attach an object (child) to another object (parent). Attachments can be created on part level and on mechanism level. When an object has been attached to a parent, moving the parent also moves the child.

One of the most common attachments is to attach a tool to a robot. For procedures, see [Attach to on page 488](#) and [Detach on page 495](#).

1 Introduction to RobotStudio

1.4.16 Keyboard shortcuts

1.4.16 Keyboard shortcuts

General keyboard shortcuts

The following table lists general keyboard shortcuts in RobotStudio.

Command	Key Combination
General Shortcuts	
Activate menu bar	F10
Open API Help	ALT + F1
Open Help	F1
Open Virtual FlexPendant	CTRL + F5
Switch between windows	CTRL + TAB
General Commands	
Add Controller System	F4
Open Station	CTRL + O
Take Screenshot	CTRL + B
Teach Instruction	CTRL + SHIFT + R
Teach Target	CTRL + R
Import Geometry	CTRL + G
Import Library	CTRL + J
New Empty Station	CTRL + N
Save Station	CTRL + S
Rotate the station	Arrow keys
Zoom the station	PgUp and PgDn
Pan the station	CTRL + arrow keys
General Editing Commands	
Copy	CTRL + C
Cut	CTRL + X
Paste	CTRL + V
Delete	DELETE
Redo	CTRL + Y
Refresh	F5
Rename	F2
Select All	CTRL + A
Save All	Ctrl+Shift+S
Undo	CTRL + Z

Continues on next page

**Note**

Robotstudio allows you to add standard commands and keyboard shortcuts to the quick access toolbar using the **Customize Quick Access Toolbar > Customize Commands** option. The quick access toolbar settings and the customized shortcuts can be saved as an *.xml file in a PC. You can export this file from one PC and later can import it to another PC.

RAPID Editor shortcuts

The following table lists the keyboard shortcuts specific to the RAPID Editor.

Command	Key Combination
RAPID Editor Intellisense	
Complete Word, displays the list of instructions that the user can select	CTRL + SPACEBAR
Parameter Info	CTRL + SHIFT + SPACEBAR
Auto Complete	TAB (when the cursor located at the end of an identifier)
General RAPID Editor Commands	
Start Program Execution	F8
Step In	F11
Step Out	SHIFT + F11
Step Over	F12
Stop	SHIFT + F8
Toggle Breakpoint	F9
Apply Changes	CTRL + SHIFT + S
Print	CTRL + P
RAPID Editor Text Commands	
Copy	CTRL + Insert or, CTRL + C
Cut	SHIFT + Delete or, CTRL + X
Cut line	CTRL + L
Delete line	CTRL + SHIFT + L
Delete to beginning of word	CTRL + BACKSPACE
Delete to end of word	CTRL + Delete
Find next occurrence	F3
Indent	Tab
Make the selected text lowercase	CTRL + U
Make the selected text uppercase	CTRL + SHIFT + U
Move to beginning of document	CTRL + Home
Move to beginning of line	Home

Continues on next page

1 Introduction to RobotStudio

1.4.16 Keyboard shortcuts

Continued

Command	Key Combination
Move to end of document	CTRL + End
Move to end of line	End
Move to next word	CTRL + Right
Move to previous word	CTRL + Left
Move to visible bottom	CTRL + Page Down
Move to visible top	CTRL + Page Up
Minimize the Ribbon	Ctrl+F1
Open line above	CTRL + Enter
Open line below	CTRL + SHIFT + Enter
Outdent	SHIFT + TAB
Paste	SHIFT + Insert or, CTRL + V
Redo	CTRL + SHIFT + Z or, CTRL + Y
Scroll down	CTRL + Down
Scroll up	CTRL + Up
Select block down	ALT + SHIFT + Down
Select block left	ALT + SHIFT + Left
Select block right	ALT + SHIFT + Right
Select block up	ALT + SHIFT + Up
Select down	SHIFT + Down
Select left	SHIFT + Left
Select page down	SHIFT + Page Down
Select page up	SHIFT + Page Up
Select right	SHIFT + Right
Select to beginning of document	CTRL + SHIFT + Home
Select to beginning of line	SHIFT + Home
Select to end of document	CTRL + SHIFT + End
Select to end of line	SHIFT + End
Select to next word	CTRL + SHIFT + Right
Select to previous word	CTRL + SHIFT + Left
Select to visible bottom	CTRL + SHIFT + Page Down
Select to visible top	CTRL + SHIFT + Page Up
Select up	SHIFT + Up
Select word	CTRL + SHIFT + W
Screenshot	Ctrl+B
Set Program Pointer to Main in all tasks	Ctrl+Shift+M
Toggle Breakpoint	F9

Continues on next page

Command	Key Combination
Toggle overwrite mode	Insert
Transpose characters	CTRL + T
Transpose lines	CTRL + ALT + SHIFT + T
Transpose words	CTRL + SHIFT + T
Virtual FlexPendant	Ctrl+F5



Note

When the user presses the ALT key, shortcut keys are displayed on the RobotStudio ribbon. Use these shortcut keys with ALT key to access the corresponding menu item.

This page is intentionally left blank

2 Building stations

2.1 Workflow of building a station

Overview

The following sections outline the workflow for building a new station. It also includes the prerequisites for creating and simulating robot programs. The workflow includes:

- Options for creating a station with a system.
- Importing or creating the objects to work with
- Optimizing the station layout by finding the best placement of robots and other equipment.



Note

For most scenarios, you are recommended to follow the workflows from start to finish, even though other sequences maybe possible.

Creating a station with a system

The table below shows the options for creating a station with a system.

For the exact procedures, see [New tab on page 211](#).

Activity	Description
Create a station with a template system	This is the simplest way to create a new station containing a robot and a link to a rudimentary system template.
Create a station with an existing system	This creates a new station containing one or more robots in accordance with an existing, built system.
Create a station with no system	An advanced user can build a station from scratch and then add a new or existing system to it.

Manually starting the VC

The table below shows the alternatives for manually starting with a system. Perform only those steps applicable to your station.

Activity	Description
Manually connecting a library to the VC	See Starting a VC on page 90 .
Restarting the VC	See Restarting a VC on page 91 .

Importing station components

The table below shows the workflow for importing station components. Perform only those steps applicable to your station.

For procedures, see [Importing a station component on page 92](#).

Activity	Description
Import a robot model	See Robot System on page 228 .
Import a tool	See Import Library on page 227 .

Continues on next page

2 Building stations

2.1 Workflow of building a station

Continued

Activity	Description
Import a positioner	See ABB Library on page 226 .
Import a track	See Import Library on page 227 .
Import other equipment	If you have CAD models of the equipment, you can import them, see Import Library on page 227 . Otherwise, you can create models in RobotStudio, see Mechanisms on page 98 .
Add work piece	If you have CAD models of the work piece, you can import them, see Workobject on page 239 . Otherwise, you can create models in RobotStudio, see Objects on page 96 .

Placing objects and mechanisms

The table below shows the workflow for placing the objects in the station.

Activity	Description
Place objects	If you are building a model of a real station, start by placing all objects with known positions. For objects without known positions, find a suitable placement, see Placing objects on page 101 and Placing external axes on page 102 .
Attach tools	Attach the tools to the robot, see Attach to on page 488 .
Attach robots to tracks	If track external axes are used, attach the robots to the tracks, see Attach to on page 488 .
Attach work pieces to positioners	If positioner external axes are used, attach the work pieces to the positioners, see Attach to on page 488 .
Test reachability	Test if the robot can reach critical positions on the work piece. If you are satisfied with how the robot reaches the positions, your station is ready for programming. Otherwise, continue adjusting the placement or trying other equipment as described below, see Testing positions and motions on page 127 .

2.2 Setting the Conveyor tracking station

2.2.1 Setting Conveyor tracking

Overview

This section describes conveyor tracking with two robot systems. The baseframes of the mechanical units in both the robot systems have the same or different task frame position.

Prerequisites

- Two robot systems with conveyor tracking option (system 1 and system 2)
- A conveyor is created as described in [Create Conveyor on page 339](#).

Setting up the conveyor tracking station

- 1 Add existing system (system 1) to the station. See [Robot System on page 228](#).
- 2 Set the position of robot / conveyor to new location:
 - a See [Updating the baseframe position on page 442](#) to update the baseframe position of the robot.
 - b Set the position of conveyor to required position
- 3 Set a connection between system1 and conveyor, see [Create connection between virtual controller and conveyor on page 340](#).

Setting up a conveyor tracking station with two robot systems

- 1 Add existing system (system 1) to the station. See [Robot System on page 228](#).
- 2 Set the position of robot / conveyor to new location:
 - a See [Updating the baseframe position on page 442](#) to update the baseframe position of the robot.
 - b Set the position of conveyor to required position.
- 3 Set a connection between system1 and conveyor, see [Create connection between virtual controller and conveyor on page 340](#).
- 4 Add the existing system (system 2) to the station. See [Robot System on page 228](#).
- 5 Modify the baseframe positions of robot (system 2).
 - a Move the mechanical unit (robot) to its new location.
 - b See [Updating the baseframe position on page 442](#) to update the baseframe position of the robot.
- 6 Set a connection between system 2 and conveyor. See [Create connection between virtual controller and conveyor on page 340](#).

Setting up conveyor tracking station with a robot system and two conveyors

- 1 Add the existing system (system 1) to the station. See [Robot System on page 228](#).

Continues on next page

2 Building stations

2.2.1 Setting Conveyor tracking

Continued

- 2 Import two conveyor libraries and set the position of robot / conveyors to new location:
 - a See [Updating the baseframe position on page 442](#) to update the baseframe position of the robot.
 - b Set the position of conveyor to required position.
- 3 In the **Controller** tab, click **Load Parameters**, and select *cnv2_eio.cfg*, *cnv2_moc.cfg* and , *cnv2_prc.cfg* files from *C:\Users\<Current User>\AppData\Local\ABB Industrial IT\Robotics IT\RobotWare\RobotWare_6.xx\options\cnv*.
- 4 Restart the controller.
- 5 Set a connection between system1 and conveyor1, and similarly between system 1 and conveyor 2, see [Create connection between virtual controller and conveyor on page 340](#).

2.3 Creating a system with external axes automatically

Automatically create a system with external axes

- 1 Import the desired robots, positioners, and track libraries into the RobotStudio station. See [Import Library on page 227](#).
If a robot and track are selected, attach the robot to the track. See [Attach to on page 488](#).
- 2 Create a robot system from layout. See [Robot System on page 228](#).



Note

To create a robot system with IRBT4004, IRBT6004, or IRBT7004, the TrackMotion mediapool must be installed. For more information, see [Installing and licensing RobotStudio on page 44](#).

Supported external axes configurations for RobotWare 5

The following table shows a combination of different external axes configurations:

Combination	Positioner type							
	A	B	C	D	K	L	2xL	R
One IRB (Positioner in same task)	Y	Y	Y	Y	Y	Y	Y	Y
One IRB (Positioner in separate task)	Y	Y	Y	Y	Y	Y	Y	Y
Two IRB (Positioner in separate task)	Y	Y	Y	Y	Y	Y	N	Y
One IRB on Track Motion (Positioner in same task)	Y	N	N	N	YX	Y	Y	N
One IRB on Track Motion (Positioner in separate task)	N	N	N	N	N	N	Y	N

- Y - Combination is supported
- N - Combination is not supported
- YX - Combination is supported and manual mapping of mechanical units and joints required



Note

Creating a system from layout only supports tracks of type RTT and IRBTx003 in combination with positioners. i.e. IRBTx004 is not supported in combination with the positioners.

Continues on next page

2 Building stations

2.3 Creating a system with external axes automatically

Continued

Supported RobotWare 6 configurations for positioners, motor units, gear units and track motions

The following table shows various RobotWare 6 configurations:

	Single system	MultiMove system	Track motion (non-dynamic model)*	Track motion (dynamic model)**	MU/MTD 1	MU/MTD 2	MU/MTD 3	IRBP L 1	IRBP L 2	IRBP A 1	IRBP A 2	IRBP C	IRBP B	IRBP D	IRBP K	IRBP R	No drives
Track		X	X														1
	X		X		X												2
	X		X					X									2
	X		X					X	X								2
	X		X							X							3
	X		X							X	X						3
	X		X										X				2
	X		X		X												2
	X		X		X			X									3
	X		X		X			X	X								3
	X		X		X								X				3
	X		X		X	X											3
MU/MTD + IRBP	X				X												1
	X				X	X											2
	X				X	X	X										3
	X				X			X									2
	X				X			X	X								3
	X				X					X							2
	X				X					X	X						3
	X				X								X				2
	X				X	X		X									3
	X				X	X		X	X								3
	X				X	X						X					3
IRBP only	X							X									1
	X							X	X								2
	X									X							1
	X									X	X						2
	X											X					1
	X												X				3
	X													X			3

Continues on next page

	Single system	MultiMove system	Track motion (non-dynamic model)*	Track motion (dynamic model)**	MU/MTD 1	MU/MTD 2	MU/MTD 3	IRBP L 1	IRBP L 2	IRBP A 1	IRBP A 2	IRBP C	IRBP B	IRBP D	IRBP K	IRBP R	No drives
	X														X		3
	X															X	3

* : Track motion that does not use a dynamic model, applicable for RTT.

** : RobotWare add-in that contains a dynamic model for track motion is used, applicable for IRBT 4004, 6004, 7004 and 2005.



Note

You can configure dynamic (IRBTx004 and IRBT2005) tracks only for T_ROB1 and T_ROB2. This is limited by RobotWare add-in for track motion.

MU does not support MultiMove in System From Layout. Dynamic tracks cannot be combined with MU.

Manual mapping of mechanical units and joints

If the system contains more than one mechanical unit, the number of tasks and base frame positions of the mechanism should be verified in the System Configuration.

- 1 On the **Controller** tab, in the **Virtual Controller** group, click **Edit System**. This opens the **System Configuration** dialog.
- 2 Select the robot from the node in the hierarchical tree.
The property page of this node contains controls for mapping and setting axes and joints.
- 3 Click **Change** to open a dialog box.
- 4 Manually map the mechanical unit and mechanism joints. Click **Apply**.
- 5 Modify the baseframe positions of the mechanical unit. See [Updating the baseframe position on page 442](#).

2 Building stations

2.4.1 Track motion of type RTT or IRBTx003

2.4 Manually setting up system based on RobotWare 5.xx with track motion

2.4.1 Track motion of type RTT or IRBTx003

Manually setting up a system with track motion of type RTT or IRBTx003

Use this procedure to manually set up a system with track motion type RTT Bobin, RTT Marathon or IRBT4003, IRBT6003, or IRBT7003.

- 1 Build and start a new system. See [Building a new system on page 167](#).

	Action	Description
1	Select the desired robot variant (IRB6600).	In the New Controller System wizard of the Installation Manager , navigate to Modify Options page and scroll down to Drive Module 1 > Drive module application group and expand ABB Standard manipulator option and select Manipulator type (IRB6600) .
2	Select the Additional axes configuration.	In the New Controller System wizard of the Installation Manager , navigate to Modify Options page of the Installation Manager , scroll down to Drive Module 1 > Additional axes configuration group and expand the Add axes IRB/drive module 6600 option and select the 770-4 Drive W in pos Y2 option. The option 770-4 Drive W in pos Y2 , the Drive module , and the Position varies depending on the Additional axes configuration selected. Make sure to select at least one drive in any position.
3	Click Finish .	Close the Modify Options page.

- 2 Add the system to the station. See [Adding a system on page 90](#)
- 3 Add the corresponding track configuration file of the desired robot variant (IRB 6600) and the desired track model to the station. See [Adding the track to the system on page 92](#).



Note

In the **Select Library** group, select either the existing track or import a different track.

The system may fail unless the correct additional axes configuration is selected.

- 4 Specify whether the baseframe is moved by another mechanism.
 - a On the **Controller** tab, in the **Virtual Controller** group, click **Edit System**. This opens the **System Configuration** dialog.
 - b Select **ROB_1** node from the hierarchical tree.
 - c Select the option **Track** from the **BaseFrame moved by** list.
 - d Click **OK**. When asked if you want to restart the system, answer **Yes**. Close the **System Configuration** window.

2.4.2 Track motion of type IRBTx004

Overview

For configuration of tracks of type IRBT4004, IRBT6004, or IRBT7004, the TrackMotion mediapool must be installed. For more information, see [Installing and licensing RobotStudio on page 44](#).

Manually setting up a system with track motion of type IRBTx004

- 1 Build and start a new system. See [Building a new system on page 167](#).

	Action	Description
1	Add add-ins for IRBTx004.	See Adding additional options on page 168 . Browse and select the key file (.kxt) located in the mediapool Track 5.XX.YYYY where 5.XX indicates the latest RobotWare version being used.
2	Select the desired robot variant (IRB6600).	On the Modify Options page of the Installation Manager , scroll down to Drive Module 1 > Drive module application group and expand ABB Standard manipulator option and select Manipulator type (IRB6600) .
3	Select Additional axes configuration .	On the Modify Options page of the Installation Manager , scroll down to Drive Module 1 > Additional axes configuratin group and expand the Add axes IRB/drive module 6600 option and select the 770-4 Drive W in pos Y2 option. The option 770-4 Drive W in pos Y2 , the Drive module , and the Position varies depending on the Additional axes configuration selected. Make sure to select at least one drive in any position.
4	Select the desired track motion (IRBT 6004).	On the Modify Options page of the Installation Manager , scroll down to the TRACK and expand the Drive module for Track motion group. Select Drive module 1 >Track Motion type >IRBT 6004 > Irb Orientation on Track > Standard carriage In Line > Select Track Motion Length > 1.7m (or any other variant) .
5	Click Finish .	Close the Modify Options page.

- 2 Add the system to the station. See [Adding a system on page 90](#).
- 3 Add the desired track model to the station using the following procedure. See [Adding the track to the system on page 92](#).
 - a In the **Select Library** group, click **Other** to import a different track motion library.
 - b Click **OK**. When asked if you want to restart the system, answer **Yes**. Close the **System Configuration** window.

2 Building stations

2.5.1 Starting a VC

2.5 Virtual controller

2.5.1 Starting a VC

Overview

RobotStudio uses virtual controllers for running the robots. Virtual controllers can run both systems for real robots and specific virtual systems for testing and evaluation purposes. A virtual controller uses the same software as the controller to execute the RAPID program, to calculate robot motions and to handle I/O signals. When starting a virtual controller, point out which system to run on it. Since the system contains information about the robots to use and important data such as robot programs and configurations, it is important to select the right system for the station.



Note

You can start and stop a virtual controller, using a given system path and without needing a station. For more information, see [Start Virtual Controller on page 383](#).

Starting a VC

The table below describes the different ways a virtual controller may start:

Startup	Description
Automatic, when creating a station	In most cases, a VC is automatically started when you create a new station. Library files for the robots used by the system are then imported to the station.
Automatic, when adding a system to an existing station	If your station uses several systems or if you started with an empty station, you can add systems to an open station. Library files for the robots used by the systems are then imported to the station.
Manually, when connecting to an imported library	If you have manually imported a robot library you want to use with a system, instead of importing a new library at startup, you can connect this library to a controller. If you have manually imported a robot library you want to use with a system, instead of importing a new library at startup, you can connect this library to a controller. A library may only be connected to a single-robot system and may not be already connected to another VC.
Manually, when starting a controller from the Controller tab.	The Start Virtual Controller commands allows you start and stop a virtual controller, using a given system path and without needing a station.

Adding a system

To add a system to a new station, see [New tab on page 211](#).

To add a system to an existing station, see [Robot System on page 228](#).

For information how to create a system with specific options, see [The System Builder on page 164](#).

To start or add a virtual controller which is not part of a station, see [Add Controller on page 382](#).

2.5.2 Restarting a VC

For information on when and how to restart a VC in RobotStudio, see [Restart a controller on page 390](#).

2 Building stations

2.6.1 Importing a station component

2.6 Station components

2.6.1 Importing a station component

Importing a robot model

This is how to import a robot model without a controller to your station.

A robot which is not connected to a controller cannot be programmed. To import a robot connected to a virtual controller, configure a system for the robot and start it in a virtual controller, see [Building a new system on page 167](#) and [Starting a VC on page 90](#), respectively.

To import a robot model, in the **Home** tab, click **Robot System** and then select a robot model from the gallery.

Importing a tool

A tool is a special object, for example, an arc weld gun or a gripper, that operates on the work piece. For achieving correct motions in robot programs, the parameters of the tool have to be specified in the tool data. The most essential part of the tool data is the TCP, which is the position of the tool center point relative to the wrist of the robot (which is the same as the default tool, *tool0*).

When imported, the tool will not be related to the robot. So in order for the tool to move with the robot, you must attach it to the robot.

To import a tool, in the **Home** tab, click **Tool** and then select a tool from the gallery.

Importing a positioner

To import a tool, in the **Home** tab, click **Positioner** and then select a positioner from the gallery.

Adding the track to the system

To select the model of the external axis to use, follow these steps:



Note

This procedure is not applicable for a robot system with track motions IRBT4004, IRBT6004, or IRBT7004. They are configured by the TrackMotion mediapool and not by adding separate configuration files. For information on installation instructions, see [Installing and licensing RobotStudio on page 44](#).

- 1 Start the system in a virtual controller, either in a new empty station or in an existing station, see [Robot System on page 228](#).
- 2 In the **Layout** browser, select the system to add the track to.
- 3 On the **Controller** tab, click **System Configuration**.
- 4 Click **Add** to add parameters for the track to the system. Browse to the parameter file (.cfg) for the track to add and click **Open**.

If you have a specific parameter file for you track, use that one. Otherwise, parameter files for some standard tracks are delivered with the RobotStudio installation. These can be found in the folder *ABB Library/ Tracks* in

Continues on next page

RobotStudio's installation folder. The *ABB Library* folder can also be opened from the Quick access pane at the left of the Open dialog box used for adding parameter files.

The file name of each parameter file tells which tracks it supports. The first part tells the length of the track and the second the number of tasks.

For example, the file TRACK_1_7.cfg supports all tracks with the length 1.7 meters in systems with one single task. For Multimove systems or other systems with several tasks, use the configuration file with the matching number of tasks.

For example, if the track length is 19.9 m and the robot attached to the track is connected to task 4 of the MultiMove system, then select TRACK_19_9_Task4.cfg file.

- 5 In the **System Configuration** window, click **OK**. When asked if you want to restart the system, answer **Yes**.
- 6 During the restart a list of all tracks compatible with the configuration file is displayed. Select the one to use and click **OK**.

After the restart the track appears in the station. Continue with attaching the robot to the track.

Importing a library, geometry or piece of equipment

A library component is a RobotStudio object that has been saved separately. Normally, components in a library are locked for editing.

A geometry is CAD data which you can import to use in RobotStudio. For a list of importable CAD formats, see [Libraries, geometries and CAD files on page 41](#).

To import a library, geometry or piece of equipment, see [Import Library on page 227](#).

2 Building stations

2.6.2 Troubleshooting and optimizing geometries

2.6.2 Troubleshooting and optimizing geometries

Overview

The characteristics of the geometries and CAD models in the station may have great effect on your work in RobotStudio, both in aspects of making the objects easier to program as well as enhancing simulation performance.

Below are some guidelines for troubleshooting geometries.

Trouble	Information
The pointer snaps to the wrong parts of the objects when selecting in the graphics window	<p>This problem might be caused by wrong snap mode settings, imprecise selecting, hidden or lack of geometrical information. To resolve these problems, do the following:</p> <ul style="list-style-type: none">• Check the selection level and snap mode settings. For more information, see Selecting an item on page 74.• When making the selection, zoom and rotate the object so that you are sure to click <i>inside</i> the object.• Check if the object has hidden details that might affect the snapping. Remove details that are not necessary for your programming or simulation. For more information, see Modifying a part on page 97.• Some file formats only contain a graphical representation and no geometrical data. Import the geometry from a file format that also contains geometrical data. For more information, see Libraries, geometries and CAD files on page 41.
The graphics window re-draws or updates slowly	<p>This might be due to the performance of your computer not being high enough for the size of the geometry files in your station.</p> <p>To reduce the size of the geometry files, do any of the following:</p> <ul style="list-style-type: none">• Use a lower detail level for rendering the geometry. For more information, see Graphic Appearance on page 499.• Check if the object has unnecessary details. Remove details that are not necessary for your programming or simulation. For more information, see Modifying a part on page 97.

Continues on next page

Trouble	Information
Parts of the geometry are not visible	<p>If parts of the geometry are not visible from some views, a probable cause is that the object is made up of 2D surfaces and the option <i>Backface culling</i> is on.</p> <p>Backface culling means that the faces of the object are only visible from the front, and if the object (or any of its faces) is oriented differently, they will not be visible.</p> <p>To correct the problem, do one of the following:</p> <ul style="list-style-type: none"> • Switch to modeling mode and invert the direction of the face that is not displayed correctly. This not only corrects the display, it also decreases the chance of faulty orientations during graphical programming. For more information, see Invert on page 506 or To invert the direction of all faces of a part on page 95. • Turn backface culling off for the specific object. This makes the object display correctly, but does not affect the direction of the face, which might cause problems if the face will be used for graphical programming. For more information, see To deactivate backface culling for a single object on page 95. • Turn backface culling off for all objects in the station. This makes the objects display correctly, but does not affect the direction of the face, which might cause problems if the face will be used for graphical programming. It also decreases the performance of the graphic handling. For more information, see To change the generic setting for backface culling on page 95.

To invert the direction of all faces of a part

To invert the direction of all faces of a part, follow these steps:

- 1 Select the part on which faces you want to invert the directions.
- 2 On the **Modify** menu, click **Graphic Appearance**.
- 3 On the **Rendering** tab, click **Flip normals** and then click **OK**.

To deactivate backface culling for a single object

To change the backface culling setting for a single object, follow these steps:

- 1 Select the part for which you want to change the backface culling setting.
- 2 On the **Modify** menu, click **Graphic Appearance**.
- 3 On the **Rendering** tab, clear the **Backface culling** check box and then click **OK**. The faces of the object will now be displayed even if the generic setting for backface culling is on.

To change the generic setting for backface culling

The generic setting for backface culling affects all new objects and existing objects that do not have backface culling specifically deactivated.

- 1 On the **File** menu, click **Options**.
- 2 On the Navigation pane to the left, select **Graphics: Performance**.
- 3 On the **Performance** page to the right, select or clear the **Cull back-facing triangles** check box and then click **OK**.

2 Building stations

2.7.1 Objects

2.7 Modeling

2.7.1 Objects

Overview

This section describes how to create or modify geometrical objects.

Creating a frame

A frame is a generic coordinate system that you can use as reference when positioning objects. Generic frames can also be converted to special kinds of coordinate systems, like workobjects or tool center points.

For procedures, see [Frame on page 236](#) and [Frame from Three Points on page 237](#).

Creating a solid

With the create solids commands you can create and build models of objects you do not have CAD files or libraries for. With the create solids commands you create primitive solid bodies; these can later be combined to more complex bodies.

For procedures, see [Solid on page 318](#).

Creating a surface

For procedures, see [Surface on page 322](#).

Creating a curve

When creating paths with targets based on the object geometries, curves are the geometrical objects that RobotStudio uses. For example, if you want the robot to run along the edge of an object, you can first create a curve along the border and then generate a complete path along that curve, instead of manually finding and creating the necessary targets.

If the CAD model/geometry of the work piece does not already contain curves, you can create the curves in RobotStudio.

For procedures, see [Curve on page 324](#).

Modifying a curve

When creating paths with targets based on the objects geometries, curves are the geometrical objects that RobotStudio uses. By optimizing the curves before starting programming, you reduce the touch-up of the generated paths.

For procedures, see [Modify Curve on page 515](#).

Creating a border

For procedures, see [Border on page 330](#).

Creating a line from normal

A line can be created as a new part and body perpendicular to a surface.

For a procedure, see [Line from Normal on page 337](#).

Continues on next page

Extruding a surface or curve

Curves and surfaces and curves can also be extruded to 3D objects, which may then be converted to solids. You can extrude along either a vector or a curve.

For procedures, see [Extrude Surface or Curve on page 335](#).

Modifying a part

When you import a geometry or create an object, it will be one part. A part can, however, contain several bodies. In RobotStudio's modeling mode you can modify the parts by adding, moving and deleting the bodies.

To modify a part, follow this step:

- 1 In the **Layout** browser, expand the node for the part to modify. Then modify the part by doing any of the following:

To	Do this
Delete a body	Select the body and press the DEL key.
Move a body from one part to another	Drag the body or use the Copy and Paste commands on the Edit menu.
Move one body relative to the others	Select the body and then move it using any of the ordinary commands for moving objects, see Placing objects on page 101 .

Modifying a library component

As external files, libraries are merely linked from a station. Therefore, to modify an imported library component, the link must first be broken and later reestablished. For procedures, see [Modify Library Component on page 509](#).

2 Building stations

2.7.2 Mechanisms

2.7.2 Mechanisms

Workflow

This information topic describes how to create a new mechanism, that is, a graphical representation of a robot, tool, external axis or device. The various parts of a mechanism move along or around axes.

Creating a mechanism is dependent upon skillful construction of the main nodes of the tree structure. Four of these—links, joints, frames/tools and calibration—are initially marked red. As each node is configured with enough subnodes to make it valid, the marking turns to green. As soon as all nodes have become valid, the mechanism will be considered compilable and can be created. For additional validity criteria, see the table below.

Node	Validity criteria
Links	<ul style="list-style-type: none">• It contains more than one subnode.• The BaseLink is set.• All link parts are still in the station.
Joints	<ul style="list-style-type: none">• At least one joint must be active and valid.
Frame/tool Data	<ul style="list-style-type: none">• At least one frame/tool data exists.• For a device, no frames are needed.
Calibration	<ul style="list-style-type: none">• For a robot, exactly one calibration is required.• For an external axis, one calibration is required for each joint.• For a tool or device, calibrations are accepted, but not required.
Dependencies	<ul style="list-style-type: none">• None.

The modify mode of the Mechanism Modeler has two purposes: to enable modification of an editable mechanism in its tree structure, and to complete the modeling of a new or modified mechanism.

It is recommended to configure each main node in the tree structure from the top down. Depending on its current status, right-click or double-click a node or subnode to add, edit or remove it.

For procedures, see [Create Mechanism on page 339](#).

2.7.3 Tools and tooldata

Overview

To simulate the robot tool, you need tooldata for the tool. If you import a predefined tool or if you create a tool using the **Create Tool Wizard**, the tooldata is automatically created; otherwise, you have to create the tooldata yourself.

The tooldata simplifies the programming work with respect to the different tools that may come in use. Defining separate sets of tooldata for different tools makes it possible to run the same robot program with different tools: only the new tooldata has to be defined. The tooldata contains the information required for moving and simulating the tool.

Two methods for manipulating tooldata in RobotStudio are as follows:

- Create or modify tooldata, see [Tooldata on page 240](#) and [Modify Tooldata on page 520](#), respectively. This will create all data necessary for programming, but there will be no visual tool during the simulation.
- Create tooldata for an existing geometry, [Create Tool on page 346](#).

Creating and setting up a stationary tool

This information topic describes how to create a stationary tool. For information about creating a robot hold tool, see [Create Tool on page 346](#).

Using a stationary tool, the robot holds and moves the work piece in relation to the tool. Thus, both the tooldata and the workobject must be set up correctly.

To create the tooldata for a stationary tool, follow these steps:

- 1 Import the geometry or library that represents the tool, see [Import Geometry on page 234](#).
If you do not have the geometry or library at hand but know the position, you can skip this step. The tool will be programable, but not visible in the station.
- 2 Create the tooldata for the tool, see [Tooldata on page 240](#).
Make sure to set the **Robot holds tool** option to **false**.
- 3 Create a workobject that is moved by the robot. see [Workobject on page 239](#).
Make sure to set the **Robot holds workobject** option to **true**.
- 4 If you have a geometry or library component for the work piece, attach it to the robot, see [Attach to on page 488](#).

2 Building stations

2.7.4 Setting the local origin of an object

2.7.4 Setting the local origin of an object

Overview

Each object has a coordinate system of its own called local coordinate system in which the object dimensions are defined. When the object's position is referred from other coordinate system, it is the origin of this coordinate system that is used. With the Set Local Origin command you reposition the object's local coordinate system, not the object itself.

For a procedure, see [Set Local Origin on page 533](#).

2.8 Placement

2.8.1 Placing objects

Overview

To achieve the required layout of your station, you need to import or create objects, place them accordingly and, if applicable, attach them to other objects.

Placing objects means setting their position and rotation. If the objects are to be attached to robots or other mechanisms, they will be placed at their attachment point automatically.

The following table describes the actions relating to placement:

Actions	Description
Placing an object	To place an object is to put the object in the required position in the station, see Place on page 525 and Set Position on page 535 .
Rotating an object	The objects in the station can be rotated to achieve the required layout, see Rotate on page 531 .
Measuring distance or angles	The measurement functions calculates distances, angles and diameters between points you select from the graphics window. When using measurements, results and instructions on how to proceed are displayed in the Output window, see The Measure Group on page 338 .
Creating a component group	A component group groups related object in the browser, see Component Group on page 282 .
Attaching or detaching an object	Objects that are to be used by the robots in any way, such as tools, need to be attached to the robot, see Attach to on page 488 and Detach on page 495 .
Jogging a robot	Robots can be placed by jogging. The robot axes can also be positioned by jogging, see Jogging mechanisms on page 109 .
Modifying the task frame	Modifying the task frame repositions a controller and all its robots and equipment in the station. By default the controller world and the station world coordinate system coincide. This is convenient when building a station with one single controller. For a procedure, see Set Task Frames on page 441 . However, when you have several controllers in one station, or need to reposition a controller in an existing station, you need to modify the Edit System on page 442 .
Modifying the baseframe position	Modifying the baseframe position sets an offset between the controller's world coordinate system and the baseframe of the mechanical unit. This is necessary when having several mechanical units belonging to one controller, for example, several robots in MultiMove systems or when using positioner external axes. For a procedure, see Edit System on page 442 .

2 Building stations

2.8.2 Placing external axes

2.8.2 Placing external axes

Overview

When starting a system with a track or positioner external axis in a RobotStudio station, you have to set up the system to load a model for the track or positioner and get the motions to work properly.

Prerequisites

The system shall be created with support for track or positioner external axes, see [A system with support for one robot and one positioner external axis on page 179](#).

Attaching the robot to the track

To attach the robot to the track, follow these steps:

- 1 In the **Layout** browser, drag the robot icon and drop it on the track icon.
- 2 To the question **Should the robot be coordinated with the track?**, answer **Yes** to be able to coordinate the track's position with that of the robot in robot programs. To program the track and the robot independently, answer **No**.
- 3 When asked if you want to restart the system, answer **Yes**.

The track is now added to the system and ready to be programmed, see [Programming external axes on page 136](#) for more information on how to program the track.



CAUTION

If you restart the system using the restart mode **Reset controller**, the setup is deleted and the procedures described here must be performed again.

Placing the positioner in the station

To place the positioner in the station, follow these steps:

- 1 Move the positioner to the desired position using any of the ordinary functions for placing and moving objects, see [Placing objects on page 101](#).
- 2 Modify the baseframe position of each mechanical unit of the positioner except the INTERCH unit, if it exists. When asked if you want to restart the system, answer **Yes**.

After the restart the system is updated with the positioner's new location. Continue attaching fixtures and workobjects to the positioner.

Attaching objects to the positioner

To program robot motions on an object that is held by the positioner, the targets must be created in a workobject that is attached to the positioner. For a complete visual simulation, CAD models that are moved by the positioner should also be attached. To attach the objects, follow these steps:

- 1 Import the models of the fixture and the work piece if you do not have them in the station already, see [Importing a station component on page 92](#).

Continues on next page

- 2 Attach the fixture to the positioner, see [Attaching and detaching objects on page 75](#). When asked whether to keep the current position, answer **No**.

If the positioner has several stations, you will be asked which one to attach the object to.

- 3 Attach the work piece to the fixture. When asked whether to keep the current position, answer **No**.
- 4 Attach the workobject in which you will program the work piece to either the fixture, the work piece or the positioner. If you have defined calibration positions on either the work piece or the fixture, it is a good practice to use that object. When asked whether to keep the current position, answer **No**.

The positioner is now set up and ready to be programed, see [Programming external axes on page 136](#) for more information.



Tip

If the positioner is of an interchangeable type with several stations, you can either attach individual fixtures, work pieces and workobjects to each station flange, or you can use one set of objects that you attach and detach to the different flanges by events.



CAUTION

If you restart the system using the restart mode **Reset controller**, the setup is deleted and the procedures described here must be performed again.

2 Building stations

2.8.3 Placing robots

2.8.3 Placing robots

Overview

When modifying the position of a robot connected to a VC there is a possibility to modify the related task frame or any stationary RAPID objects (tooldata, workobjects) connected to the robot.

Prerequisites

A robot library must be present in the station and connected to a VC, see [Creating a station with a system on page 81](#).

Modifying the robot position using a positioning tool

- 1 Modify the baseframe position of a robot connected to a VC using any of the following options:
 - Set Position. See [Positioning an item on page 535](#).
 - Place object by One Point, Two Points, Three Points, Frame, and Two Frames. See [Placing an item on page 525](#).
 - Rotate. See [Rotating an item on page 531](#).
- 2 Click **Apply**.

To the question, **Do you also want to move the Task Frame?**. Click **Yes** or **No**.

 - Click **Yes** to move the task frame, but the base frame keeps its relative placement to the task frame.
 - Click **No** to move the base frame and the placement relative to the task frame will change.



Note

If there are any stationary RAPID objects (tooldata, workobjects) in the corresponding task, the following question appears **Do you want to keep the positioning of all stationary RAPID objects?**

- Click **Yes** to keep all the stationary RAPID objects in their global coordinates.
- Click **No** to move all the stationary RAPID objects along with the base frame (same coordinates relative to base frame). Workobjects attached to any other object in the station will not be affected. Workobjects attached to any other object in the station will not be affected.

If the base frame configuration of the VC is updated, the VC has to be restarted for the changes to take effect. i.e. if the base frame changes its placement relative to task frame, the following question appears **Do you want to update the controller configuration and restart?**

- Click **Yes** to restart the controller and update the base frame configuration of the connected VC.
- Click **No** if the base frame is not in accordance with the controller.

Continues on next page

Modifying the robot position using Freehand move or rotate

- 1 Modify the baseframe position of a robot connected to a VC using the following Freehand options:

- Move. See [The Freehand Group on page 265](#).
- Rotate. See [Rotating an item on page 266](#).

For information on updating the robot baseframe, see [Updating the baseframe position on page 442](#).

- 2 A warning message is displayed in the Output window.

This page is intentionally left blank

3 Programming robots

3.1 Workflow for programming a robot

Overview

In most cases, going through the workflow from start to finish is recommended, even if it is possible to work in other sequences as well.

Synchronizing will save and load text files containing RAPID modules, and create RAPID programs from your station.

Prerequisites

Before creating a program for your robot, you should set up the station, including robots, work pieces and fixtures, in which your robot will work.

Programming a robot

The table below describes the workflow for programming a robot to perform the task you require.

Task	Description
Create targets and paths	<p>Create the targets and paths the robot requires to perform the work tasks.</p> <p>To create targets and paths, do one of the following:</p> <ul style="list-style-type: none"> • Create a curve to match your required shape. Then use the Create path from curve command to generate a path, complete with targets, along the shape you have created. See Curve on page 324 and AutoPath on page 248. • Create targets at the requested positions, then create a path and insert the created targets into it. See Create Target on page 242, Teach Target on page 241 and Empty Path on page 247.
Check the target orientations	<p>Make sure that the targets are oriented in the most efficient way for the tasks to be performed. If not, reorient the targets until you are satisfied. See Orientations on page 116.</p>
Check reachability	<p>Check that the robot and tool reach all targets in the path. See Testing positions and motions on page 127.</p>
Synchronize the program to the virtual controller	<p>Generates RAPID code from the RobotStudio items and enables the program to be simulated.</p>
Perform text-based editing	<p>If you need to edit the instructions or data created by RobotStudio, you can start the RAPID Editor. See Examples of using the RAPID editor on page 475.</p>
Collision detection	<p>Check that the robot or tool does not collide with the surrounding equipment or the fixtures. If it does, adjust the placements or orientations until no collisions occur. See Detecting collisions on page 147.</p>
Test the program	<p>Test the program by moving along the paths. See Testing positions and motions on page 127.</p>

3 Programming robots

3.2 Workobjects

3.2 Workobjects

Creating a workobject

A workobject is a coordinate system used to describe the position of a work piece. The workobject consists of two frames: a user frame and an object frame. All programmed positions will be related to the object frame, which is related to the user frame, which is related to the world coordinate system.

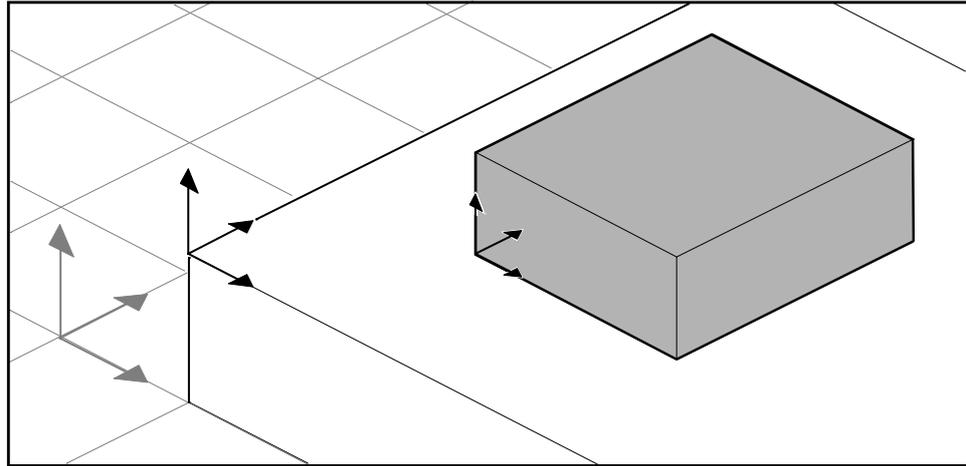

xx050000

For creating a workobject, see [Workobject on page 239](#).

Modifying a workobject

For a procedure, see [Modify Workobject on page 521](#).

Converting a frame to a workobject

You can create a new workobject from an existing frame. The converted workobject gets the same name and position as the selected frame.

For a procedure, see [Convert Frame to Workobject on page 491](#).

Creating a frame by points

You can create a frame by specifying points on the axes of the coordinate system and letting RobotStudio calculate the placement and orientation of the frame's origin.

For a procedure, see [Frame from Three Points on page 237](#).

3.3 Jogging mechanisms

Jogging a robot

To check if the robot can reach all positions on the work piece, you can jog the TCP or the joints of the robot, either with the freehand commands or through dialog boxes. Jogging the robot close to its boundaries is best done with the latter method.

To	Procedure
Jog the joints of a robot	For freehand, see Jog Joint on page 267 . For a dialog box, see Mechanism Joint Jog on page 510 .
Jog the TCP of a robot	For freehand, see Jog Linear on page 268 . For a dialog box, see Mechanism Linear Jog on page 512 .

Prerequisites

To jog the TCP of a robot, the robot's VC must be running.

Jogging several mechanisms

Function	Description
Multirobot jog	When using multirobot jog, all selected mechanisms will follow the TCP of the one being jogged. Multirobot jog is available for all kinds of jogging. See MultiRobot Jog on page 270 .
Jogging with locked TCP	When jogging a mechanism that moves a robot (like a track external axis) with locked TCP, the robot will reposition so that the position of the TCP does not change, even though its baseframe is moved. When jogging an external axis that moves the work object with locked TCP, the robot will reposition so that its TCP follows the work object in the same way as when using multirobot jog. Locked TCP is available when jogging a mechanism that belongs to the same task as a robot. See Mechanism Joint Jog on page 510 .

3 Programming robots

3.4 Targets

3.4 Targets

Creating a target

You can create a new target manually either by entering the position for the target in the **Create Target** dialog box or by clicking in the graphics window.

The target will be created in the active workobject.

For a procedure, see [Create Target on page 242](#).

Creating a jointtarget

A jointtarget is a specification of the position for the robot axes.

For a procedure, see [Create Jointtarget on page 244](#).

Teaching targets

You can create a new target by jogging the robot and teaching a target at the active TCP. Taught targets will be created with the axis configuration used when jogged to the target.

The target will be created in the active workobject.

For a procedure, see [Teach Target on page 241](#).

Modifying a target position

By using the modify position command you can modify the position and rotation of a target.

For procedures, see [Set Position on page 535](#) and [Rotate on page 531](#), respectively.

Modifying a target with ModPos

The position of an existing target can be modified by jogging the robot to a new, preferred position. By selecting a move instruction for the target in a path, the ModPos command can be used to move the target to the TCP of the active tool.

When ModPos is executed, the target, referenced to by the move instruction, will be updated with the following information:

- position and orientation corresponding to the TCP of the active tool
- the current configuration of the active robot
- the current position and orientation values of all active external axes for the active robot



Note

To jog a robot linearly, a virtual controller must be running for that robot. For detailed information, see [Starting a VC on page 90](#).

Renaming targets

With this command you can change the name of several targets at once. You can either rename targets individually, or you can rename all targets in one or several paths at once.

Continues on next page

The new target names will consist of an optional prefix, an incremental number and an optional suffix.

For a procedure, see [Rename Targets on page 529](#).

When renaming targets, make sure that the new targets conform to the naming rules. The target names must:

- start with an alphabetical character in the ISO 8859-1 encoding (that is, an ordinary letter from the English alphabet)
- be shorter than 16 characters
- not be empty strings
- not contain any characters illegal in RAPID. See *RAPID reference manual* for details.

Removing unused targets

If deleting or changing paths or move instructions during programming, you might end up with large numbers of targets that are no longer used in any instructions. To make the workobjects and their targets easier to grasp, you can delete all unused targets.

For a procedure, see [Remove Unused Targets on page 528](#).

3 Programming robots

3.5 Paths

3.5 Paths

Creating an empty path

A path is a sequence of targets with move instructions that the robot follows. An empty path will be created in the active task.

For a procedure, see [Empty Path on page 247](#).

Creating a path from curve

If the work piece has curves or contours that correspond to the path to be created, you can create the paths automatically. The create path from curve command generates paths, complete with targets and instructions along existing curves.

The path will be created in the active task.

The orientation of the targets that will be created will be according to the settings of the approach/travel vectors in the **Options** dialog box.

To create a path from a curve, the curve must have first been created in the station. See [AutoPath on page 248](#).

Setting robot axis configuration for paths

The robot axis configuration specifies the position of the axes as the robot moves from target to target, when multiple solutions are possible.

If a target is unreachable with the current configuration, but reachable with a configuration other than the one specified, a yellow warning icon is displayed by the corresponding move instruction icon in the **Paths&Targets** browser. If it is unreachable with any configuration, then a red icon is displayed.

Use the Configurations function on the move instruction to change the configuration. Alternatively, you can use the **AutoPath** function on the path to automatically set working configurations.

Note that a move instruction may fail to execute even though the target is indicated as reachable. This applies particularly to linear or circular instructions where the configuration of the preceding target also affects the ability of the robot to move from one target to the next. See [Robot axis configurations on page 39](#) for more information about configurations.

To set a configuration for all targets in a path, see [Configurations on page 489](#).

To set a configuration for a single target, see [Configurations on page 490](#).

Reversing paths

The reverse path commands change the sequence of targets in the path so that the robot moves from the last target to the first. When reversing paths, you can reverse either the target sequence alone or the entire motion process.

For procedures, see [Reverse Path on page 530](#).



Note

When reversing paths, the original paths are deleted. If you want to keep them, make copies before reversal.

Continues on next page



Note

When reversing paths, only move instructions are handled. Action instructions, if any exist, have to be inserted manually after the reversal.

Rotating paths

With the rotate path command you can rotate complete paths and move the targets used by the paths accordingly. When rotating paths, the included targets will lose their axis configurations, if any have been assigned.

A frame or target must exist at the position to rotate around before starting the rotate path command.

For a procedure, see [Rotate Path on page 532](#).

Translating a path

The translate path function moves a path and all included targets.

For a procedure, see [Translate Path on page 537](#).

Compensating paths for tool radius

You can offset a path so that it compensates for the radius of a rotating tool. Since the targets in the path are moved, they will lose their axis configurations, if any have been assigned.

For a procedure, see [Tool Compensation on page 536](#).

Interpolating a path

The interpolate functions reorient the targets in a path so that the difference in orientation between the start and end targets is distributed evenly among the targets in between. The interpolation can be either linear or absolute.

Linear interpolation distributes the difference in orientation evenly, based on the targets' positions along the length of the path.

Absolute interpolation distributes the difference in orientation evenly, based on the targets' sequence in the path.

Below are examples of the difference between linear and absolute interpolation.

The interpolate functions reorient the targets in a path so that the difference in orientation between the start and end targets is distributed evenly among the targets in between. The interpolation can be either linear or absolute.

Continues on next page

3 Programming robots

3.5 Paths Continued

For a procedure, see [Interpolate Path on page 505](#).

No interpolation

This is the path before any interpolation. Note that the last target is oriented differently than the others.

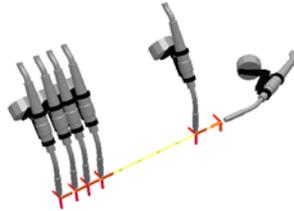

xx050026

Linear interpolation

This is the same path after linear interpolation.

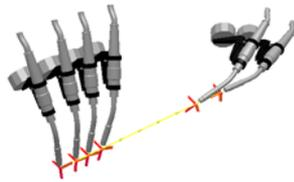

xx050027

Note that the targets are oriented based on their placement relative to the start and end targets.

If a target were moved and you reran the linear interpolation, it would be reoriented according to its new position.

If new targets were inserted between the existing ones and you reran the linear interpolation, it would not affect the orientation of the existing targets.

Absolute interpolation

This is the same path after absolute interpolation

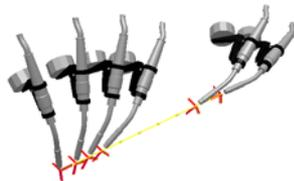

xx050028

Note that the targets are orientated based on their sequence in the path: each target has been reoriented equally, regardless of its place.

If a target were moved and you reran the absolute interpolation, it would not affect the orientation.

If new targets were inserted between the existing ones and you reran the absolute interpolation, it would change the orientation of all targets.

Continues on next page

Mirroring a path

The mirror path function mirrors all motions instructions and their targets to a new path.

For a procedure, see [Mirror Path on page 513](#).

3 Programming robots

3.6 Orientations

3.6 Orientations

Overview

This is an overview of the tools for automating the modification of target orientations. When creating paths from curves in RobotStudio, the orientation of the targets depends on the characteristics of the curves and the surrounding surfaces. Below is an example of a path with unordered target orientations and examples of how the different tools have affected the targets.

Unordered orientations

In the path below, the target orientations are unordered. The function View tool at target has been used for illustrating how the targets point in different directions.

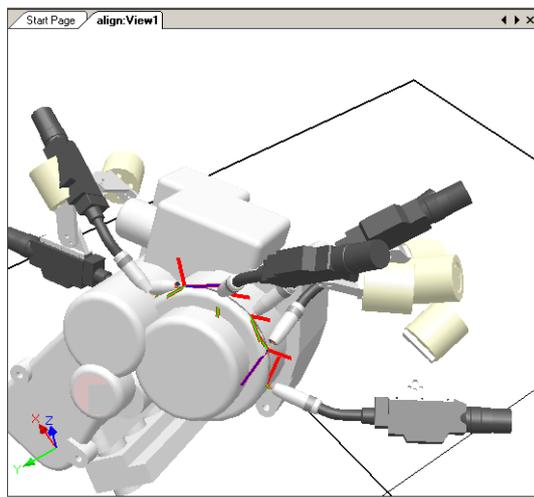

xx050029

Continues on next page

Effect of target normal to surface

In the picture below, the targets, which previously were orientated randomly, have been set normal to the flat round surface at the right side of the path. Note how the targets' Z axis has been orientated normal to the surface; the targets have not been rotated in the other directions.

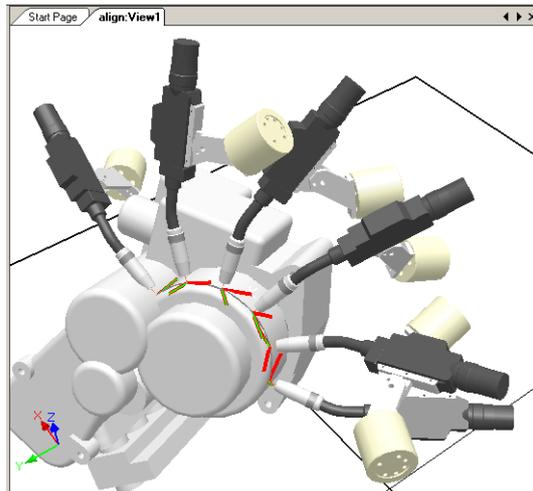

xx050030

Setting a target normal to surface

To set a target orientation normal to a surface is to make it perpendicular to the surface. The target can be oriented normal to the surface in two different ways:

- The entire surface can be used as a reference for the normal. The target will be oriented as the normal to the closest point at the surface. The entire surface is the default surface reference.
- A specific point on the surface can be used as the reference for the normal. The target will be orientated as the normal to this point, regardless of whether the normal to the closest point at the surface has another orientation.

Objects imported without geometry (for example, .jt files) can only refer to specific points on the surface.

For a procedure, see [Set Normal to Surface on page 534](#).

Continues on next page

3 Programming robots

3.6 Orientations

Continued

Effect of align target orientation

In the picture below, the targets, which were previously orientated with the Z axis normal to the surface but with the X and Y axes orientated randomly, have been organized by aligning the targets' orientation around the X axis with the Z axis locked. One of the targets in the path has been used as reference.

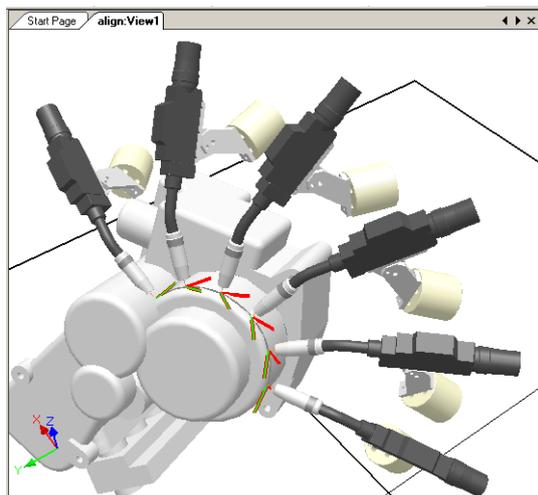

xx050031

Aligning a target orientation

With the align target orientation command you align the rotation of selected targets around one axis without changing the rotation around the others.

For a procedure, see [Align Target Orientation on page 487](#).



Tip

You can also align ordinary frames in the same way.

Continues on next page

Effects of copy and apply orientation

In the picture below, the targets, which were previously oriented randomly, have been organized by copying the exact orientation of one target to all the others. This is a quick way to fix workable orientations for processes where variations in approach, travel, or spin directions either do not matter or are not affected, due to the shape of the work piece.

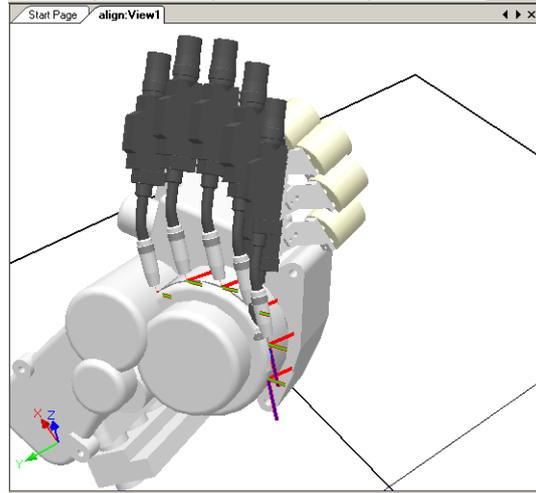

xx050032

Copying and applying an orientation for objects

To transfer an orientation from one object to another is an easy way to align different frames for simplifying the programming of the robot. Target orientations may also be copied.

For procedures, see [Copy / Apply Orientation on page 494](#).

3 Programming robots

3.7 RAPID Instructions

3.7 RAPID Instructions



Note

For information on the RAPID Editor, which is used for creating and modifying RAPID program code, see [RAPID tab on page 445](#).

Move and action instructions

For RAPID programming, RobotStudio's main advantage is in the area of motion programming.

A move instruction is an instruction for the robot to move to a specified target in a specified manner. With RobotStudio, you can create move instructions in three ways:

Method	Description
Create a move instruction based on an existing target	Creates move instructions based on one or several targets selected in the Paths&Targets browser. For a procedure, see Add to Path on page 485 .
Create a move instruction and a corresponding target	Creates a move instruction and a corresponding target at once. The position of the target can either be selected from the graphics window or typed numerically. For a procedure, see Move Instruction on page 259 .
Teach a move instruction	Teaching a move instruction creates a move instruction and a corresponding target at the robot's current position. Teaching a move instruction also stores the current configuration with the target. For a procedure, see Teach Instruction on page 258 .

In addition to move instructions, you can also create and insert action instructions from RobotStudio. An action instruction is an instruction other than a move instruction that can, for example, set parameters, or activate or deactivate equipment and functions. The action instructions available in RobotStudio are limited to those commonly used for affecting the robot's motions. For inserting other action instructions or another kind of RAPID code in the program, use the RAPID Editor. For a procedure, see [Action Instruction on page 260](#).

The table below lists the action instructions that can be created. For details, see the RAPID Reference Manual.

Action instruction	Description
ConfL On/Off	ConfL specifies whether to monitor the robot's configurations during linear movements. When ConfL is set to Off, the robot may use another configuration than the programmed one for reaching the target during program execution.
ConfJ On/Off	ConfJ specifies whether to monitor the robot's configurations during joint movements. When ConfJ is set to Off, the robot may use another configuration than the programmed one for reaching the target during program execution.
Actunit <i>UnitName</i>	Actunit activates the mechanical unit specified by <i>UnitName</i> .
DeactUnit <i>UnitName</i>	Deactunit deactivates the mechanical unit specified by <i>UnitName</i> .

Continues on next page

Action instruction	Description
ConfJ On/Off	ConfJ specifies whether to monitor the robot's configurations during joint movements. When ConfJ is set to Off, the robot may use another configuration than the programmed one for reaching the target during program execution.
Actunit <i>UnitName</i>	Actunit activates the mechanical unit specified by <i>UnitName</i> .
DeactUnit <i>UnitName</i>	Deactunit deactivates the mechanical unit specified by <i>Unit-Name</i> .

Modifying an instruction

Most instructions have arguments that specify how the instruction shall be carried out. For example, the MoveL instruction has arguments that specify the speed and accuracy with which the robot moves to the target.

For a procedure, see [Modify Instruction on page 518](#).



Note

Some arguments are read from the virtual controller. If the virtual controller has not been started, only the arguments stored in the station can be modified.

Converting to move circular

To create a circular motion to an instruction target, you must convert the motion type to circular motion (that is, MoveC in RAPID).

A circular motion is defined by two motion instructions, where the first is the via-point and the second contains the end point of the circular motion.

The circular motion can only be used for open circular arcs, not for closed circles. To create a path for a closed circle, use two circular motions.

For a procedure, see [Convert to Move Circular on page 493](#).

Creating RAPID instructions for setting I/O signals

For controlling I/O signals in the robot program, you use RAPID commands that set the signals. These require that you first create instruction templates for the instructions that set the signals. See *RAPID reference manual* for details about the instructions that control I/O signals.

To add RAPID instructions that set I/O signals, follow these steps:

- 1 Synchronize the system in which you want to add the instructions to the virtual controller, see [Synchronization on page 139](#).
- 2 In programming mode, select the module for editing, right-click it and then click **Edit program**.
- 3 In the RAPID editor, add the instructions for setting the signals.
- 4 When you are done adding instructions, synchronize the task and paths from the Virtual Controller back to the station.

Continues on next page

3 Programming robots

3.7 RAPID Instructions

Continued

Using cross-connections and groups for setting I/O signals

You can also create cross-connections and signal groups, which make one signal set the value of several other signals. See *System parameters reference manual* for details about cross-connections and groups.

To make one signal set several others, follow these steps:

- 1 Request write access, and then open the configuration topic I/O in the configuration editor. Add configure instances for the cross-connections and groups to create.

Instruction templates

Instruction templates contain predefined sets of argument values that are applied to the instructions you create using the template. You can create templates for all instructions in the system running on the virtual controller. To see which instructions are available and what their arguments do, see the RAPID reference manual for your RobotWare version and the reference sections in manuals for software options, if you have any installed on the system.

Move instruction templates are always part of *process templates*. The process templates contain one instruction template for each type of move instruction that might be used by the process.

The *process templates* are instances of *process definitions*, which define the types of move instructions (*move instruction definitions*) that might be used by the process.

To create new move instruction templates, start by creating a new process template for a process that uses the type move instructions you want to create templates for. If such a process does not exist, you first have to create a new process definition.

If no *move instruction definition* for the type of instruction you want to create a template for exists, you must create it first.

When creating instruction descriptions, the virtual controller must be running, since the available instruction types are read from the system.

Templates can be imported and exported on four levels: tasks, move instruction descriptions, action instruction descriptions and process definitions. The default directory for imported and exported template files is *My Documents/RobotStudio*. Simply choosing another directory will then make that directory default. As a default .xml is the file format.

The validation procedure checks for duplicate names, incomplete process definitions and virtual controller equality. It is performed automatically, after a template file has been imported or a node renamed or deleted.

For procedures, see [Instruction Template Manager on page 261](#).

Instruction Template Manager

The Instruction Template Manager is used to add support for instructions other than the default set that comes with the RobotStudio.

For example, a robot controller system with the RobotWare Dispense option has specialized move instructions related to glueing like DispL and DispC. You can

Continues on next page

manually define the instruction templates for these using the Instruction Template Manager. The instruction templates are exported to XML format and reused later.

The instruction template supports the following Robotware options:

- Cap (Continuous Application Process)
- Disp (Dispense)
- Trigg (Fixed Position Events)
- Spot Pneumatic
- Spot Servo
- Spot Servo Equalizing
- Paint

RobotStudio has pre-defined XML files that are imported and used for robot controller systems with the appropriate RobotWare options. These XML files has both the Move and Action instructions.



Note

Use RobotStudio ArcWelding PowerPac while using RobotWare Arc.

Creating a process template with move instruction templates



Note

Move instructions are always related to processes.

- 1 On the **Home** tab, from the active **Task** list, select the task for the robot for which you want to create the instruction template.
- 2 On the **Create** menu, click **Instruction Template Manager**. This opens the Instruction templates page in the work space.
- 3 In the **Instruction Templates** tree to the left, make sure there are move instruction definitions for the types of move instructions you want to create templates for. If not, follow the procedure in [Creating a move instruction description on page 124](#) for creating them.
- 4 Make sure there is a process definition that uses the types of move instructions you want to create templates for. If not, follow the procedure in [Creating a process definition on page 124](#) for creating it.
- 5 Right-click the *process definition* for which you want to create a new templates and click **Create Process Definition**.
- 6 In the **Create Process Definition** dialog box, enter a name, with characters from ASCII set, for the new template and click **Create**. A new process template node with a set of move instruction templates is now created.
- 7 Select each new template one at a time, and in the arguments grid to the right of the tree view, set the argument values that shall be applied when you create new instructions based on the template. Finish for each template by clicking **Apply changes** at the bottom of the grid.

Continues on next page

3 Programming robots

3.7 RAPID Instructions

Continued

For details about available arguments and what they do, see the RAPID reference manual for ordinary RAPID instructions and the option manual for software option instructions.

Creating a move instruction description

To create templates for other instructions than the one that already exists in the tree view, you first have to create an instruction description that defines the arguments that belong to the instruction. To create the instruction description, follow these steps:

- 1 Right-click the **Move Instructions** node and click **Create Move Instruction Description**. This opens the **Create Move Instruction Description** dialog box.
- 2 In the **Controller Description** list, select the instruction you want to make a description for. All action instructions installed on the controller, both through RobotWare and software options, are available.
- 3 In the **Motion type** list, select the motion type for the instruction.
- 4 Optionally, in the **Information text** box, enter a comment to the instruction.
- 5 Click **Create**. The instruction description appears in the tree view and its settings are displayed in the grid.
- 6 In the instruction grid, set the **point type** values. If necessary, also change the other settings.
- 7 After changing the settings, click **Apply Changes** in the bottom of the grid view.

Editing an instruction template

To edit an instruction template, follow these steps:

- 1 In the active task list, select the task for the robot for which you want to edit the instruction template.
- 2 On the **Create** menu, click **Instruction Template Manager**. This opens the Instruction templates page in the work space.
- 3 In the **Instruction Templates** tree to the left, browse to and select the template to edit.
- 4 In the arguments grid to the right of the tree view, set the argument values that shall be applied when you create new instructions based on the template. Finish by clicking **Apply changes** at the bottom of the grid.

For details about available arguments and what they do, see the RAPID reference manual for ordinary RAPID instructions and the option manual for software option instructions.

Creating a process definition

To create a process definition, follow these steps:

- 1 Make sure there are move instruction definitions for the types of move instructions you want to create templates for. If not, follow the procedure above for creating them.

Continues on next page

- 2 Right-click the **Process definitions** node and click **Create Process Definition**. This opens the Create Process Description dialog box.
- 3 In the **Create Process Definitions** dialog box, enter a name for the process definition, a name for its first process template and then select the move instruction types to use. Finish by clicking **Create**.

Creating an action instruction template

To create a template for an action instruction, follow these steps:

- 1 In the active task list, select the task for the robot for which you want to create the instruction template.
- 2 On the **Home** menu, click **Instruction Template Manager**.
- 3 In the **Instruction Templates** tree to the left, right-click the instruction description (corresponding to the instructions as described in the RAPID reference manual) for which you want to create a new template and click **Create Action instruction Template**.

If the instruction description does not exist in the tree, create it by following the procedure described in [Creating an action instruction description on page 125](#).

- 4 In the **Create Action Instruction Template** dialog box, enter a name for the new template and click **Create**. The new template is now created under the instruction description node it belongs to.
- 5 Select the new template and in the arguments grid to the right of the tree view, set the argument values that shall be applied when you create new instructions based on the template. Finish by clicking **Apply changes** at the bottom of the grid.

For details about available arguments and what they do, see the RAPID reference manual for ordinary RAPID instructions and the option manual for software option instructions.

Creating an action instruction description

To create templates for other instructions than the one that already exists in the tree view, you first have to create an instruction description that defines the arguments that belong to the instruction.

To create the instruction description, follow these steps:

- 1 Right-click the **Action Instructions** node and click **Create Action Instruction Description**. This opens the **Create Instruction Description** dialog box.
- 2 In the **Controller Description** list, select the instruction you want to make a description for. All action instructions installed on the controller, both through RobotWare and software options, are available.
- 3 Optionally, in the **Information text** box, enter a comment to the instruction.
- 4 Click **Create**. The instruction description appears in the tree view, and its settings are displayed in the grid.

After changing the settings (if necessary), click **Apply Changes** in the bottom of the grid view.

Continues on next page

3 Programming robots

3.7 RAPID Instructions

Continued

- 5 Continue with creating templates for the instruction description, as described in [Creating an action instruction template on page 125](#).

3.8 Testing positions and motions

Overview

RobotStudio has several functions for testing how robots reach and move to targets. They are useful both for finding the optimal layout when building a station and during programming.

Below are brief descriptions of the functions for testing reachability and motions.

Checking reachability

The reachability status of move instructions are displayed in the **Paths&Targets** browser. The four states of reachability are as follows:

- Unknown (before checking)
- Reachable (no indication)
- Reachable with other configuration (yellow icon in browser)
- Unreachable (red icon in browser and red move instruction in graphics view)

To change a configuration for all targets in a path, see [Configurations on page 489](#).

To change a configuration for a single target, see [Configurations on page 490](#).

A target may be unreachable even though there is no indication by the move instruction and this is because the configuration may not allow the robot to move from the preceding target according to the specified motion type. This typically applies to linear or circular move instructions where the robot is required to move along a straight line or along a circular arc.

The reachability of a target also depends on the tool and work object of the move instructions and hence the reachability status is only displayed in relation to move instructions.

Jumping to target

Jump to target tests whether the robot can reach a specific position. This is useful when building the station: by creating targets at critical positions on the work piece and jumping the robot to them, you get an early indication of whether the items are positioned correctly or not. For a procedure, see [Jump to Target on page 507](#).

Viewing a robot at target

When View robot at target is activated, the robot is automatically positioned with the tool at the target when one is selected. If several robot axis configurations are possible for reaching the target, the robot will use the one nearest the configuration it had before jumping to the target. For a procedure, see [View Robot at Target on page 538](#).

Viewing tool at target

View tool at target displays the tool at target, without checking that the robot can reach it. This test is useful both when building the station and when programming the robot, since the orientation of targets both affects the reachability and the process performance. For a procedure, see [View Tool at Target on page 539](#).

Continues on next page

3 Programming robots

3.8 Testing positions and motions

Continued

Executing move instructions

Execute move instruction tests if the robot can reach a specific position with the programmed motion properties. This is useful for testing motions during programming. For detailed information, see [Execute Move Instruction on page 497](#).

Moving along path

Move along path executes all move instructions in a path. It is thereby a more complete test than Execute move instructions, but not as complete as a full simulation, since it ignores RAPID code that is not move instructions. For a procedure, see [Move Along Path on page 522](#).

Moving to a pose

Moving to a pose moves a mechanism to a predefined joint value at a predefined time without using the Virtual Controller. This is useful when movement of the external equipment (such as a clamp or conveyer) must be simulated. For a procedure, see [Move to Pose on page 523](#).

Simulating programs

Simulating programs involves running a program on the virtual controller as it is run on a real controller. It is the most complete test whereby you can see how the robot interacts with external equipment through events and I/O signals. For a procedure, see [Simulation Setup on page 353](#).

Improving the reachability

If the robot cannot reach the target, or if you are not satisfied with the motions, try the following for improving the reachability:

- 1 Set ConfL or ConfJ to Off for enabling the robot to use new configurations for reaching the target.
- 2 Change the orientation of the target.
- 3 Change the position of either the robot or the work piece.
- 4 Use a system with a track external axis for increasing the robot's range.
- 5 Use a system with a positioner external axis for enabling different work piece positions for different targets.

3.9 Programming MultiMove systems

3.9.1 About programming MultiMove

About MultiMove

The MultiMove functions help you create and optimize programs for MultiMove systems where one robot or positioner holds the work piece and other robots operate on it. Below is an outline of the main workflow for programming MultiMove systems with RobotStudio, with references to detailed instructions further down in the section.

Prerequisites

For using the MultiMove functions you must first have the following:

- A virtual controller running a MultiMove system started in RobotStudio, see [A MultiMove system with two coordinated robots on page 194](#) for an example.
- All coordinate systems and tools used by the system.
- The paths along which the tool shall move. The paths must be created in a workobject that belongs to a tool robot and is attached to the work piece robot. A wizard will guide you through attaching the workobjects if this has not been done before starting the MultiMove functions.

For detailed information about MultiMove in RobotWare systems and RAPID programs, see *MultiMove application manual*.

Normal workflow

This is the typical workflow for creating MultiMove programs using the MultiMove function:

Action	Description
Setting up the MultiMove	Select the robots and paths to use in the program, see Setting up the MultiMove on page 131 .
Testing the MultiMove	Execute the motion instructions along the paths, see Testing the MultiMove on page 132 .
Tuning the motion behavior	Tune motion behavior, such as tolerances and constraints for TCP motions, see Tuning the motion behavior on page 133 .
Creating the program	Generate the tasks for the robots, see Creating paths on page 135 .

Continues on next page

3 Programming robots

3.9.1 About programming MultiMove

Continued

Additional actions

In addition to using the functions that calculate and create optimized MultiMove paths, you can program MultiMove manually using a combination of the ordinary programming tools in RobotStudio and a set of tools specific for MultiMove programming.

The main actions for programming MultiMove manually are outlined below. Not all actions might be necessary, but the order in which they shall be carried out depends on the contents of the station and your goals.

Action	Description
Creating Tasklists and Syncidents	This data specifies the tasks and paths that shall be synchronized with each other. See The Create Tasklist tool on page 257 and The Create Syncident tool on page 257 , respectively.
Adding and updating ID arguments to the instructions to synchronize	To add IDs to the instructions, you can use one of the following methods: Using The Recalculate ID tool on page 256 to add and update IDs for instructions in paths that already are synchronized. Using The Convert path to MultiMove path tool on page 257 to add IDs to instructions in paths that have not yet been synchronized.
Adding and adjusting Sync instructions to the paths.	Add <code>SyncMoveon/Off</code> or <code>WaitSyncTask</code> instructions to the paths to synchronize and set their tasklist and Syncident parameters. See Creating an action instruction on page 260 .
Teaching MultiMove instructions	It is also possible to jog all robots to the desired positions and then teach instructions to new synchronized paths. See MultiTeach tab on page 253 .

3.9.2 Setting up the MultiMove

Selecting robots and paths

This procedure is for selecting the robots and paths in the station that shall be used for the MultiMove program. All robots for the MultiMove program must belong to the same system.

- 1 On the **Home** tab, click **MultiMove**. Click the **Setup** tab below the MultiMove work area.
- 2 In the work area, click the **System config** bar for expanding the system config section.
- 3 In the **Select System** box, select the system that contains the robots to program.
The robots of the selected system are now displayed in the System grid below the Select system box.
- 4 For each robot that shall be used in the program, select the check box in the **Enable** column.
- 5 For each robot that shall be used in the program, specify whether it carries the tool or the work piece using the options in the **Carrier** column.
- 6 In the work area, click the **Path config** bar for expanding the path config section.
- 7 Select the **Enable** check box for the tool robot and click the expand button. This displays the paths of the robot.
- 8 Select the order of the paths to execute by specifying them in right order using **Path name** column.
- 9 For each path that shall be included in the program, select the check box in the **Enable** column.
- 10 When you have set up the robots and paths, continue testing the Multimove and then tune the motion properties, if necessary.

3 Programming robots

3.9.3 Testing the MultiMove

3.9.3 Testing the MultiMove

Overview

Testing the MultiMove executes the motion instructions along the paths according to the current settings on the setup and motions properties pages.

Testing Paths

This procedure is for setting the robots start position and testing the resulting movements along the path sequence.

- 1 Jog the robots to what seems to be a good start position.
- 2 On the **Home** tab, click **MultiMove**. Click the **Test** tab at the bottom of the MultiMove work area for displaying the test area.
- 3 Optionally, select the **Stop at end** check box to make the simulation stop after moving along the paths. Clearing this check box makes the simulation continue in a loop until you click **Pause**.
- 4 Click **Play** to simulate the motions along the paths based on the current start position.

If you are satisfied with the motions, continue generating multimove paths. If the simulation cannot complete or if you are not satisfied with the motions, pause the simulation and perform any of the actions below to adjust the motions:

Action	Description
Examine the robots' positions for critical targets.	Click Pause and then use the arrow buttons to move to one target a time.
Jog the robots to new start positions.	New start positions might result in changed motions, since the robots will use different configurations. In most cases, positions near the robots' joint limits shall be avoided.
Go to the Motion Behavior tab and remove constraints.	The default setting for the motion properties is no constraints. If this has been changed, constraints might exist that limit motions more than necessary.

3.9.4 Tuning the motion behavior

Overview

Tuning the motion behavior means to set up rules for the robot's motions, for example, constraints on the position or orientation of the tool. Generally, the MultiMove program will obtain the smoothest motions with the fastest cycle and process times with as few constraints as possible.

For procedures, see [Motion Behavior tab on page 250](#).

Modifying the joint influences

The joint influence controls the balance of how much the robots will use their joints. Decreasing the weight value for one axis will restrict the motion for this axis, while increasing it will promote motion on this axis relative to alternative axes.

- 1 On the **Home** tab, click the **Motion Behavior** tab.
- 2 Expand the **Joint Influence** group by clicking its title bar.
- 3 In the Select Robot box, select the robot whose joint influence you want to modify.

The weight values for the robot axes are now displayed in the grid.

- 4 For each axis whose motion you want to restrict or promote, adjust the Weight value. A lower value restricts, and a higher value promotes, motions on that axis.
-

Modifying the TCP constraints

The joint influence controls the balance of how much the robots will use their joints. Decreasing the weight value for one axis will restrict the motion for this axis, while increasing it will promote motion on this axis relative to alternative axes.

- 1 On the **Simulation** tab, click the **Motion Behavior** tab.
 - 2 Expand the **TCP Constraints** group by clicking its title bar.
The directions and rotations in which you can constrain the TCP's motion are now displayed in the grid
 - 3 For each pose you want to constrain, select the **Enable** check box and specify the constraint values (location in the TCP coordinate system). To use the values from the current TCP position, click **Pick from TCP**.
 - 4 Optionally, adjust the **Weight** value for the constraint. A low value results in a harder constraint, while a high value allows a larger deviation.
-

Modifying the tool tolerance

The joint influence controls the balance of how much the robots will use their joints. Decreasing the weight value for one axis will restrict the motion for this axis, while increasing it will promote motion on this axis relative to alternative axes.

- 1 On the **Simulation** tab, click the **Motion Behavior** tab.
- 2 Expand the **Tool Tolerance** group by clicking its title bar.

The directions and rotations in which you can enable tolerances are now displayed in the grid

Continues on next page

3 Programming robots

3.9.4 Tuning the motion behavior

Continued

- 3 For each offset you want to set, select the **Enable** check box.
- 4 In the **Value** column, specify the allowed deviation.
- 5 Optionally, adjust the **Weight** value for the tolerance. A low value increases the use of the tolerance, while a high value promotes motions that do not use the tolerance.

Modifying the tool offset

The tool offset sets a fixed distance between the tool and the paths.

- 1 On the **Simulation** tab, click the **Motion Behavior** tab.
- 2 Expand the **Tool Offset** group by clicking its title bar.
The directions and rotations in which you can set offsets are now displayed in the grid.
- 3 For each offset you want to set, select the **Enable** check box.
- 4 In the **Offset** column, specify the offset distance.

3.9.5 Creating paths

Overview

When you are satisfied with the motions displayed when testing the Multimove program, the next step is to convert the temporary move instructions used by the MultiMove function to ordinary paths in RobotStudio.

Creating the paths

To create paths for the MultiMove program in RobotStudio, follow these steps:

- 1 On the **Home** tab, click **Create Paths** tab.
- 2 Expand the **Settings** group by clicking on the its title bar.
- 3 Optionally, change the naming settings in the following boxes:

Box	Description
Start ID	Specify the first ID number for the synchronization of the instructions for the robots.
ID step index	Specify the increment between ID numbers.
Sync ident prefix	Specify a prefix for the syncident variable, which connects the sync instructions in the tasks for the tool robot and the work piece robot with each other.
Task list prefix	Specify a prefix for the tasklist variable, which identifies the tasks for the tool robot and the work piece robot to synchronize.

- 4 Expand the **WP Robot Settings** group by clicking on its title bar and then check the settings in the following boxes:

Box	Description
WP Workobject	Specify the workobject to which the targets generated for the workpiece robot shall belong.
WP TCP	Specify which tooldata the workpiece shall use when reaching its targets.
Path prefix	Specify a prefix for the generated paths.
Target prefix	Specify a prefix for the generated targets.

- 5 Expand the **Generate path** group by clicking on its title bar and then click **Create Paths**.

3 Programming robots

3.10 Programming external axes

3.10 Programming external axes

Overview

This is a brief overview of the functions and commands for programming external axes in RobotStudio. For a more detailed description of external axes and how to program them, see the product manual for the external axis to use and the *RAPID reference manual*.

Coordinated motions

Normally, external axes are used to move the workpiece, the robot or any other mechanism. The motions of an external axis can be coordinated with those of a robot in two ways, depending on the task in which the external axis is defined.

Task for external axis	Coordination method
Same task as the robot's	<p>If the external axis is in the same task as the robot, the current position of active external axes is stored with each target that is created. When the robot then moves to the target, the external axis will move to the stored position as well.</p> <p>Modifying and optimizing the position of positioner external axes can be automated using the MultiMove function, or be performed manually for selected targets. Positions of track external axes can only be modified manually.</p> <p>For information about using the MultiMove function, see About programming MultiMove on page 129. For information about how to modify the position of external axes manually, see below.</p>
Other task than the robot's	<p>If the external axis is in another task than that of the robot it shall be coordinated with, the motions of the external axis are created by <i>MoveExt</i> instructions, and the coordination is made by <i>sync</i> instructions.</p> <p>For positioner external axes creating or optimizing <i>MoveExt</i> and <i>sync</i> instructions can be automated way using the MultiMove function, or be performed manually by creating a path with <i>MoveExt</i> instructions for the positioner and then adding <i>sync</i> instructions to the path for the robot and the external axis. Track external axes can only be programed manually.</p> <p>For information about using the MultiMove function see About programming MultiMove on page 129. For information about how to use the <i>sync</i> instructions, see <i>RAPID reference manual</i> and <i>MultiMove application manual</i>.</p>

Modifying positions of external axes

When programming external axes, you often need to adjust the position of the external axis for some targets. For example, if you create a path from curves on a work piece that is attached to a positioner, the positioner will initially have the same position for all targets. By repositioning the work piece for some of the targets you might improve process time and reachability.

When targets are created in stations with a coordinated external axis, the position values of the external axis are stored in the target. With the Modify External Axis function you can reposition the external axis, thus making it possible for the robot to reach the target in new ways. For a procedure, see [Modify External Axis on page 517](#).

Continues on next page

To modify the external axis values for a target, the following conditions must be met:

- The external axis must be added to the system and set up correctly. For examples of how to add support for an external axis to a system, see [A system with support for one robot and one positioner external axis on page 179](#). For information about how to set up an external axis in a RobotStudio station, see [Placing external axes on page 102](#).
- The external axis must be defined in the same task as the robot.
- The external axis must be activated.

Activation and deactivation

Activating a mechanical unit makes it controlled and monitored by the controller. Consequently, the mechanical unit must be activated before programming or running programs. If a system uses several external axes or interchangeable models with several work stations, several mechanical units might share common drive units. If this is the case, you must make sure to set the mechanical unit as active.

For more information about activating and deactivating mechanical units, see *RAPID reference manual* on the instructions *ActUnit* and *DeactUnit*.

Activating and deactivating mechanical units can be done either manually, see [Activate Mechanical Units on page 362](#), or programmatically by RAPID instructions, see below.

To activate or deactivate mechanical units programmatically

To set the mechanical units to be active programmatically by RAPID instructions, follow these steps:

- 1 In the **Paths&Targets** browser, browse down to the path in which you want to insert the activation or deactivation instruction. To insert it as the first instruction in the path, select the path node and to insert it between existing instructions, select the instruction before the intended insertion point.
- 2 On the **Home** tab, click **Action Instruction** to bring up a dialog box.
- 3 In the **Instruction Templates** list, select one of the **ActUnit** or **DeactUnit** instructions.
- 4 In the **Instruction Arguments** grid and the **MechUnit** list, select the unit to activate or deactivate.
- 5 Click **Create**. When the path is executed either through the Move along path command, or running the RAPID program, the instruction will be carried out.

3 Programming robots

3.11 Loading and saving programs and modules

3.11 Loading and saving programs and modules

Overview

RAPID programs and modules are normally stored in the RobotWare systems, as they are created. You can also save the programs to files on the PC, which makes it possible to load them to other controllers, either other virtual controllers or real IRC5 controllers.

Programs are saved from the VC

When saving a program to files on the PC from RobotStudio, it is the RAPID program stored in the system of the VC that is saved. This program is created and updated by synchronizing the station to the VC, see [Synchronize to RAPID on page 447](#).

Procedures

To create or load a module or load a program, see:

- [Creating a new RAPID module on page 455](#)
- [Loading a RAPID module on page 455](#)
- [Loading a RAPID program on page 459](#)

To save a module or program, see:

- [Saving a RAPID module on page 456](#)
- [Saving a program on page 459](#)

3.12 Synchronization

Overview

To synchronize is to make sure that the RAPID program in the system running on the virtual controller corresponds to the programs in RobotStudio. You can synchronize both from RobotStudio to the virtual controller and from the virtual controller to RobotStudio.

In a RobotStudio station, robot positions and movements are defined by targets and move instructions in paths. These correspond to data declarations and RAPID instructions in the modules of the RAPID program. By synchronizing the station to the virtual controller, you create RAPID code out of the data in the station. By synchronizing the virtual controller to the station, you create paths and targets out of the RAPID program in the system running on the virtual controller.

When to synchronize the station to the VC

Synchronizing the station to the VC updates the RAPID program of the virtual controller with the latest changes in the station. This is useful to do before:

- Performing a simulation.
- Saving a program to files on the PC.
- Copying or loading RobotWare systems.

To synchronize a station to the VC, see [Synchronize to RAPID on page 447](#).

When to synchronize the VC to the station

Synchronizing the VC to the station creates paths, targets and instructions that correspond to the RAPID program in the system running on the virtual controller. This is useful to do when you have:

- Started a new virtual controller which system contains existing programs.
- Loaded a program from a file.
- Text-edited the program.

To synchronize the VC to a station, see [Synchronize to Station on page 446](#).

This page is intentionally left blank

4 Deploying and distributing

4.1 Copying programs

Overview

RAPID programs are normally stored in the systems that run on the virtual controllers of your station. To copy programs to systems on other controllers, save the programs to file on the PC and then load these files to the destination controllers. You can save either entire programs or specific modules.

Copying a program

To copy a program from one controller to another, follow these steps:

- 1 In the **Controller** browser, select the controller that contains the program to copy.
- 2 Save the program to file on the disc. For details, see [Saving a program on page 459](#).
- 3 If necessary, copy the files to a location that is accessible to the other controller.
- 4 For instructions on loading the program to a system on a virtual controller, a FlexController or a non-running system, see the table below.

System location	Do this
Virtual controller, running in RobotStudio	See Loading a RAPID program on page 459 .
FlexController	Connect to the FlexController and load the program.
A non-running system stored on the PC	Start the system in a virtual controller, then load the program, see Adding a system on page 90 and Loading a RAPID program on page 459 , respectively.

4 Deploying and distributing

4.2 Pack & Go / Unpack & Work

4.2 Pack & Go / Unpack & Work

Overview

The Pack & Go / Unpack & Work feature makes it possible to create a package (zip file) of an active station that can be unpacked on another computer. The package contains all necessary files, except media pools, but add-in based media pools are included.

For procedures, see [Pack and Go on page 213](#) and [Unpack and Work on page 214](#).

4.3 Screen Capture

Overview

Screen capture entails two functions useful for demonstrations and training purposes:

- The Screenshot function which allows you to capture an image of the application.
- The Record Movie function which allows you to make a recording of your work in RobotStudio, either of the entire GUI or just the graphics window.

Taking screenshots

The Screenshot function allows you to capture an image of the entire application or an active document window such as the graphics window.



Note

The Screenshot feature is available only for RobotStudio Premium users.

Configure the options for the screenshot function as per your requirement under Options:General:Screenshot in the File tab. For more information, see [Options:General:Screenshot on page 219](#).

You can take screenshots using the keyboard shortcut CTRL + B. Alternatively, you can use the **Screenshot** button on the Quick Access Toolbar, but you must enable it first.

To enable the screenshot command button:

- 1 Click the Quick Access Toolbar's down arrow. The Customize Quick Access Toolbar menu is displayed.
- 2 Click **Screenshot** to add the check mark to the command. This adds the screenshot button to the Quick Access Toolbar.

Recording movies

You can record your activities in the RobotStudio application as a video. You can also record videos of simulations. For information on how to record videos in RobotStudio, see [Record Movie on page 377](#).

This page is intentionally left blank

5 Simulating programs

5.1 Simulation Overview

About this chapter

This chapter describes how to simulate and validate robot programs. Below are short introductions to the simulation functions in RobotStudio.

Function	Description
Play simulations	Simulations run entire robot programs on a virtual controller. Before you run a simulation you need to decide which paths are to be simulated. To set up a simulation, see Simulation Setup on page 353 . To run a simulation, see Simulation Control on page 363 .
Collision detection	Collision detection displays and logs collisions and near-misses for specified objects in the station. Normally used during simulation of robot programs, it can also be used when building the station. For more information, see Detecting collisions on page 147 .
Event handling	Events can be used to connect an action to a trigger. For example, you can attach one object to another when they collide or a signal is set. For more information, see Creating an event on page 150 .
I/O Simulation	In simulations I/O signals are normally set either by the robot program or by events. With the I/O simulator you can set signals manually, which provides a quick test of specific conditions. For more information, see Simulating I/O signals on page 151 .
Simulation Monitoring	With the simulation monitoring functions you enhance the simulation by adding traces along the TCP movements or alerts triggered by defined speeds or motions. For more information, see Enabling simulation monitoring on page 152 .
Process time measurement	With the process timer you measure the time for a process to complete. For more information, see Measuring simulation time on page 153 .

Time handling during simulation

When simulating stations with events or several controllers, or other time managing equipment, time can be managed in two modes: either as *free runtime* or as *time slices*. RobotStudio uses time slice mode by default, but you can switch to free runtime, if required.

Free runtime

Since all controllers use the same computer resources, their synchronization might not be exactly as in the real world if they run independently of each other (called *free run mode*). The cycle time will be correct, but the timing for setting signals and triggering events might be inaccurate.

Continues on next page

5 Simulating programs

5.1 Simulation Overview

Continued

Time Slice

Time slices can be used to ensure that the timing for signals and other interaction between controllers is accurate. In this mode, RobotStudio synchronizes the controllers by dividing a time segment into small slices and waiting for all controllers to complete a current time slice before any controller can start anew. Thus, the controllers are synchronized, and the cycle time will be calculated correctly. The drawbacks are that the virtual FlexPendant cannot be open, and that the simulation might be somewhat slow and jerky, depending on the complexity of the simulation and the performance of the computer.



Note

If the simulation uses events or involves several different controllers, the virtual time mode **Time Slice** shall be used to make sure that the timing between the controllers is correctly simulated.

5.2 Detecting collisions

Overview

With RobotStudio you can detect and log collisions between objects in the station. The basic concepts of collision detection are explained below.

Collision sets

A collision set contains two groups, *Objects A* and *Objects B*, in which you place the objects to detect any collisions between them. When any object in *Objects A* collides with any object in *Objects B*, the collision is displayed in the graphical view and logged in the output window. You can have several collision sets in the station, but each collision set can only contain two groups.

A common use of collision sets is to create one collision set for each robot in the station. For each collision set you then put the robot and its tool in one group and all objects you do not want it to collide with in the other. If a robot has several tools, or holds other objects, you can either add these to the robot's group as well or create specific collision sets for these setups.

Each collision set can be activated and deactivated separately.

Collisions and near-misses

In addition to collisions, the collision detection can also watch for near-misses, which is when an object in *Objects A* comes within a specified distance from an object in *Objects B*.

Recommendations for collision detection

In general, the following principles are recommended to facilitate collision detection:

- Use as small collision sets as possible, splitting large parts and collecting in the collision sets only relevant parts.
- Enable coarse detail level when importing geometry.
- Limit the use of near-miss.
- Enable last collision detection, if the results are acceptable.

Results of creating a collision set

After you have created a collision set, see [Create Collision Set on page 352](#), RobotStudio will check the positions of all objects and detect when any object in *ObjectsA* collides with any object in *ObjectsB*.

Activation of detection and display of collisions depend on how the collision detection is set up.

If the collision set is active, RobotStudio will check the positions of the objects in the groups, and indicate any collision between them according to the current color settings.

Continues on next page

5 Simulating programs

5.2 Detecting collisions

Continued

Collision detection

Collision detection checks whether robots or other moving parts collide with equipment in the station. In complex stations, you can use several collision sets for detecting collisions between several groups of objects.

After collision detection has been set up, it does not need to be started, but automatically detects collisions according to the setup.

Setting when to check for collisions

To set whether to detect collisions always or only during simulation, follow these steps:

- 1 On the **File** menu, click **Options**.
- 2 On the Navigation pane to the left, select **Simulation: Collision**.
- 3 On the Collision page to the right, select one of the following options from the **Perform collision detection**:

Option	Description
During simulation	Collision detection is active only during simulation (when running RAPID programs in the virtual controller).
Always	Collision detection is always active, even when moving objects manually or testing reachability.

Modifying a collision set

To modify a collision set, follow these steps:

- 1 Right-click the collision set and then select **Modify Collision set** from the context menu. The **Modify Collision set** dialog box opens.
- 2 Select or enter the required values in various fields provided in the dialog box.
- 3 Click **Apply**.

The **Modify Collision set** dialog box provides the following options:

Options	Description
Active	Collisions between objects in this set will be detected.
Near miss(mm)	Specifies the maximum distance between the objects to be considered a near miss.
Highlight colliding	Lets the user select the colliding object (part, body, or surface) that must be highlighted when two objects collide. It also creates a temporary markup at the point of collision or near miss.
Collision color	Displays the collision in the selected color.
Near miss color	Displays the near miss in the selected color.
Show markup at collision	Shows markup at collision or near miss.
Detect collisions between invisible objects	Detect collisions even if the objects are invisible.

Continues on next page

Setting the objects for collision detection

To set the objects for collision detection, follow these steps:

- 1 Make sure that the objects for collision detection are placed correctly in collision sets.
- 2 Make sure that the collision set for the objects is activated, which is indicated by an icon in the Layout browser:

Icon	Description
 xx050033	Active. Collisions between objects in this set will be detected.
 xx050007	Not active. Collisions between objects in this set will not be detected.

To activate or deactivate collision sets, continue with the following steps:

- 3 Right-click the collision set to change and then click **Modify Collision set** to bring up a dialog box.
- 4 Select or clear the **Active** check box and then click **Apply**.

Setting near-miss detection

Near-misses occur when objects in collision sets are close to colliding. Each collision set has its own near-miss settings. For setting near-miss detection, follow these steps:

- 1 In the **Layout** browser, right-click the collision set to change and then click **Modify Collision set** to bring up a dialog box.
- 2 In the **Near miss** box, specify the maximum distance between the objects to be considered a near-miss and then click **Apply**.

Setting logging options

In addition to the graphical display of collisions, you can also log the collisions to the output window or a separate log file:

- 1 On the **File** menu, click **Options**.and under **Simulation**, click **Collision**.
- 2 On the Navigation pane to the left, select **Simulation: Collision**.
- 3 On the Collision page to the right, select **Log collisions to Output window** check box.

The collision log is displayed in the output window.

- 4 On the Collision page to the right, select **Log collisions to file** check box and enter the name and path to the log file in the box.

A separate file for logging collisions is created below the check box.

5 Simulating programs

5.3 Creating an event

5.3 Creating an event

Overview

Events enhance your simulations by defining actions that are carried out when specific trigger conditions are fulfilled. You can use events to:

- Attach one object to another, for example, a work piece to a gripper when simulating material handling, see [Attaching and detaching objects on page 75](#).
- Set signals, for example, when simulating signals set by equipment other than the controller, see [Simulating I/O signals on page 151](#).
- Start or stop the process timer, see [Measuring simulation time on page 153](#).

Used for creating new events, the **Create New Event Wizard** is launched from the Event manager, see [Event Manager on page 355](#).

Prerequisites

Before creating the event, make sure that the station contains all signals and objects that are planned to be used as triggers or affected by the action.

5.4 Simulating I/O signals

Procedures

When simulating I/O signals you can either create events that set signal values when specified trigger conditions are fulfilled, or you can set signal values manually.

For procedures using the event manager, see [Event Manager on page 355](#).

For procedures using the I/O simulator, see [I/O Simulator on page 364](#).

Related information

For information about controlling I/O signals from the RAPID program, see [Creating RAPID instructions for setting I/O signals on page 121](#).

5 Simulating programs

5.5 Enabling simulation monitoring

5.5 Enabling simulation monitoring

Overview

The simulation monitor commands are used to visually detect critical robot movements during simulation by drawing a colored line that follows the TCP.

To enable TCP tracing

To enable TCP tracing, follow these steps:

- 1 On the **Simulation** tab, click **Monitor** to bring up a dialog box.
 - 2 In the left pane, select the appropriate robot.
 - 3 On the **TCP Trace** tab, select the **Enable TCP Trace** check box. This activates TCP tracing for the selected robot.
 - 4 Optionally, change the length and color of the trace. For detailed information, see [Monitor on page 366](#).
-

To enable simulation alerts

To enable simulation alerts, follow these steps:

- 1 On the **Simulation** menu, click **Monitor** to bring up a dialog box.
- 2 In the left pane, select the appropriate robot.
- 3 On the **Alerts** tab, select the **Enable Simulation Alerts** check box. This activates simulation alerts for the selected robot.
- 4 In the threshold value boxes, specify the threshold for the alerts. Setting the threshold to 0 is equivalent to disabling the alert. For detailed information, see [Monitor on page 366](#).

5.6 Measuring simulation time

Stopwatch feature for measuring simulation time

The Simulation tab's **Stopwatch** feature is used for measuring the time taken between two trigger points in a simulation, and also for the simulation as a whole. The two trigger points are called the Start Trigger and the End Trigger.

When a stopwatch is setup, the timer starts when the Start Trigger occurs, and stops when the End Trigger occurs. The kinds of triggers you can specify are:

- Simulation Start
- Simulation Stop
- Target Changed

Additionally, specify the mechanical Unit and the target.

- I/O Value

Additionally, specify the source mechanical unit from where the signal comes, the type of I/O signal and the value of the signal.

You can several stopwatches setup for a simulation. You can also specify a different name for each stopwatch.

For information on how to use the Stopwatch feature, see [Stopwatch on page 367](#)



Tip

While you are on the *Simulation* tab, you can check the RobotStudio status bar for the Simulation Time, that is, from simulation start to simulation stop.

This page is intentionally left blank

6 Working online

6.1 Connecting a PC to the controller

General

In general there are two ways of physically connecting a PC to the controller, to the service port or to the factory network port.

The service port

The service port is intended for service engineers and programmers connecting directly to the controller with a PC.

The service port is configured with a fixed IP-address, which is the same for all controllers and cannot be changed, and has a DHCP server that automatically assigns an IP-address to the connected PC.

The factory network port

The factory network port is intended for connecting the controller to a network.

The network settings can be configured with any IP-address, typically provided by the network administrator.

Limitations



Note

The maximum number of connected network clients using Robot Communication Runtime is:

- LAN port: 3
- Service port: 1
- FlexPendant: 1

The maximum number of applications using Robot Communication Runtime running on the same PC connected to one controller has no built-in maximum. However, UAS limits the number of logged-on users to 50.

The maximum number of concurrently connected FTP clients is 4.

Continues on next page

6 Working online

6.1 Connecting a PC to the controller

Continued

Ports on the computer unit DSQC 639

The illustration below shows the two main ports on the computer unit DSQC 639, the service port and the LAN port.

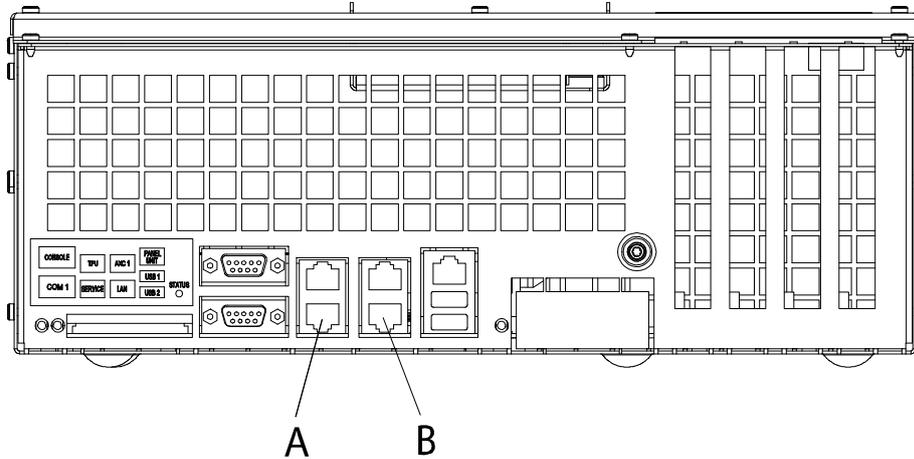

connecti

A	Service port on the computer unit (connected to the service port on the controller front through a cable).
B	LAN port on the computer unit (connects to factory network).



Note

The LAN port is the only public network interface to the controller, typically connected to the factory network with a public IP-address provided by the network administrator.

Continues on next page

Ports on the computer unit DSQC1000

The illustration below shows the two main ports on the computer unit DSQC1000, the service port and the WAN port.

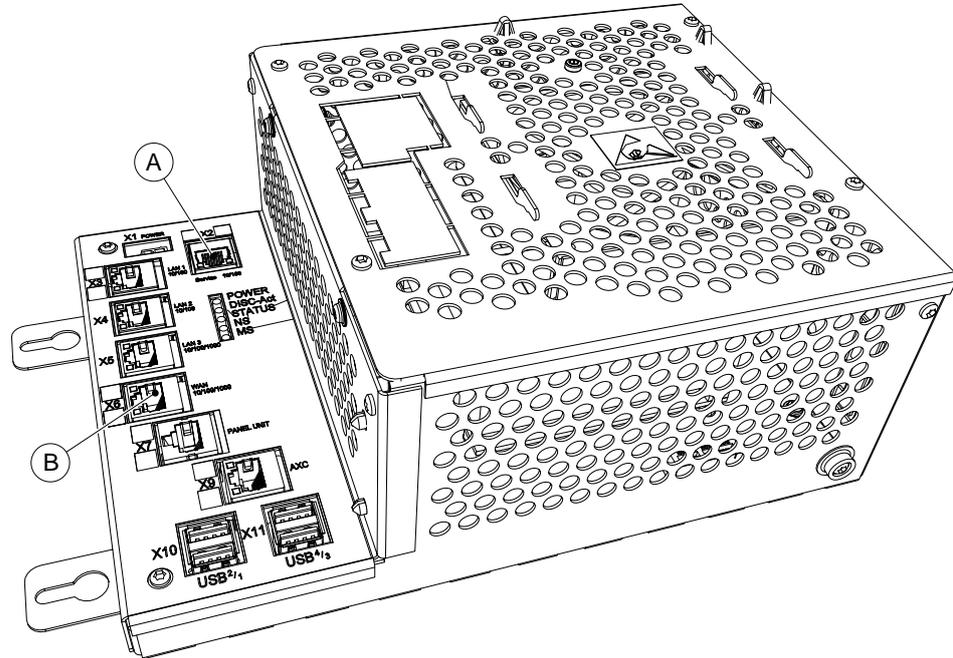

xx130000609

A	Service port on the computer unit (connected to the service port on the controller front through a cable).
B	WAN port on the computer unit (connects to factory network).

**Note**

The WAN port is the only public network interface to the controller, typically connected to the factory network with a public IP-address provided by the network administrator.

LAN1, LAN2, and LAN3 can only be configured as private networks to the IRC5 controller.

Continues on next page

6 Working online

6.1 Connecting a PC to the controller

Continued

Connecting a PC to the controller

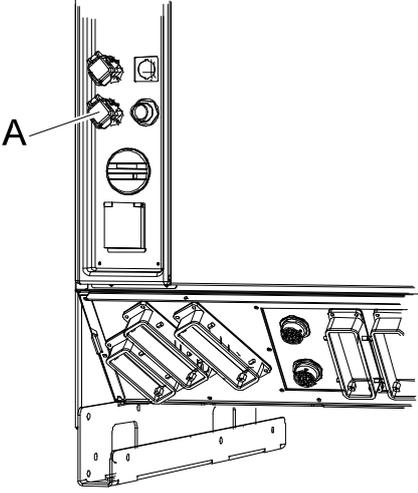
	Action	Note
1	<p>Make sure that the network setting on the PC to be connected is correct.</p> <p>When connecting to the service port:</p> <ul style="list-style-type: none">The PC must be set to “Obtain an IP address automatically” or set as described in Service PC Information in the Boot Application on the FlexPendant. <p>When connecting to the factory network port:</p> <ul style="list-style-type: none">The network settings for the PC depend on the network configuration setup by the network administrator.	<p>Refer to the system documentation for your PC, depending on the operative system you are running.</p> <p>For more information, see Network settings on page 159.</p>
2	Connect a network cable to the network port of your PC.	
3	<p>When connecting to the service port:</p> <ul style="list-style-type: none">Connect the network cable to the service port on the controller, or to the service port on the computer unit. <p>When connecting to the factory network port:</p> <ul style="list-style-type: none">Connect the network cable to the factory network port on the computer unit.	 <p>The diagram shows the rear panel of a controller. At the top, there is a vertical section with several ports. A label 'A' with an arrow points to a specific port in this section. Below this section is a horizontal section with several ports, including what appears to be a factory network port. The text 'connectb' is written below the diagram.</p> <p>connectb</p> <p>A Service port on the controller</p>

6.2 Network settings

Overview

This topic describes the network settings for a PC connected to a controller, which is a prerequisite for working online.

You can connect the PC to the controller through an Ethernet network in the following ways:

- Local network connection
- Service port connection
- Remote network connection

Local network connection

You can connect your PC to the same Ethernet network that the controller is connected to. When the PC and the controller are connected correctly and to the same subnet, the controller will be automatically detected by RobotStudio.

The network settings for the PC depend on the network configuration. For setting up the PC, contact the network administrator.

Service port connection

When connecting to the controller's service port, you can either obtain an IP address for the PC automatically, or you can specify a fixed IP address.

If you are not sure how to set up the service port connection, contact the network administrator.

Automatic IP address

The controller's service port has a DHCP server that will automatically give your PC an IP address if it is configured for this. For detailed information see Windows help on configuring TCP/IP.

Fixed IP address

Instead of obtaining an IP address automatically, you can also specify a fixed IP address on the PC you connect to the controller.

Use the following settings for a fixed IP address:

Property	Value
IP address	192.168.125.2
Subnet mask	255.255.255.0

For detailed information about how to set up the PC network connection, see Windows help on configuring TCP/IP.

Continues on next page

6 Working online

6.2 Network settings

Continued



Note

Obtaining an IP address automatically might fail if the PC already has an IP address from another controller or Ethernet device.

To ensure that you get a correct IP address if the PC was previously connected to an Ethernet device, do one of the following:

- Restart the PC before connecting to the controller.
- Run the command `ipconfig /renew` from the command prompt after connecting the PC to the controller.

Remote network connection

To enable a connection to a controller on a remote subnet or over the local network, the relevant network traffic must be allowed through any firewalls between the PC and the controller.

The firewalls must be configured to accept the following TCP/IP traffic from the PC to the controller:

- UDP port 5514 (unicast)
- TCP port 5515
- Passive FTP

All TCP and UDP connections to remote controllers are initiated by the PC, that is the controller only responds on the given source port and address.

Firewall settings

The firewall settings are applicable irrespective of whether you are connected to a real controller or a virtual controller.

The following table describes the necessary firewall configurations:

Status	Name	Action	Direction	Protocol	Remote Address	Local Service	Remote Service	Application
	RobNetscan-Host	Allow	Out	UDP/IP	Any	Any	5512,5514	robnetscan-host.exe
	IRS5Controller	Allow	In	UDP/IP	Any	5513	Any	robnetscan-host.exe
	RobComCtrlServer	Allow	Out	TCP/IP	Any	Any	5515	robcomctrlserver.exe
	RobotFTP	Allow	Out	TCP/IP	Any	Any	FTP(21)	Any
	RobotStudio	Allow	Out	HTTP	Any	Any	80	RobotStudio.exe
	RobotStudio	Allow	Out	HTTPS	Any	Any	443	RobotStudio.exe



Note

Port 443 is not required for controller communication, but it is required for external communication with ABB for availing services like upgrade notifications and online services.

Continues on next page

In addition, the following table describes the necessary firewall configurations for the RobotWare option, Integrated Vision:

Status	Name	Action	Direction	Protocol	Remote Address	Local Service	Remote Service	Application
	Telnet	Allow	Out	TCP/IP	Any	Any	23	RobotStudio.exe
	In-Sight Protocol	Allow	Out	TCP/IP	Any	Any	1069	RobotStudio.exe
	In-Sight Discovery	Allow	In/Out	UDP/IP	Any	1069	1069	RobotStudio.exe
	Upgrade port (PC only)	Allow	Out	TCP/IP	Any	Any	1212	RobotStudio.exe
	DataChannel	Allow	Out	TCP/IP	Any	Any	50000	RobotStudio.exe



Note

RobotStudio uses the current Internet Options, HTTP, and proxy settings to get the latest RobotStudio news. To view the latest RobotStudio news, go to the **File** tab and then the **Help** sub-tab.

Connecting to the controller

- 1 Make sure the PC is connected to the controller's service port and that the controller is running.
- 2 On the **File** menu, click **Online** and then select **One Click Connect**.
This takes you to the **Controller** tab.
- 3 Click **Add Controller**
- 4 Click **Request Write access**.

If the controller is in mode	Then
Auto	You will now get Write Access if it is available.
Manual	A message box on the FlexPendant will allow you to grant remote Write Access to RobotStudio.

6.3 User Authorization

Overview

This section describes the controller's User Authorization System (UAS), which restricts what different users are allowed to do with the robot. This is for protecting data and functionality from unauthorized use.

The user authorization is managed by the controller, which means that the UAS settings remain for the controller regardless of which system it is running. It also means that the UAS settings apply to all tools for communicating with the controller, like RobotStudio or the FlexPendant. The UAS settings defines the users and groups that can access the controller, and what actions they are granted access to.

For procedures, see [User Accounts on page 423](#).

Users

UAS users are accounts with which persons log on to the controller. Furthermore, the users are added to groups to which access grants are given.

The users are defined in the controller by a user name and a password. For logging on to a controller, the user must type in a defined user name with a correct password.

A user can either have the state activated or deactivated in the UAS. When a user is deactivated it is not possible to log on to the controller using that account. It is the UAS administrator that activates and deactivates the users.

The Default user

All controllers have a default user named *Default User* with a publicly known password *robotics*. The *Default User* cannot be removed and the password cannot be changed. However, a user having the grant *Manage UAS settings* can modify and restrict the controller grants and application grants of the *Default User*.



Note

From RobotWare 6.04 it is also possible to deactivate the *Default User*, see [User Accounts on page 423](#).

Groups

In UAS, groups are defined sets of grants for accessing the controller. To the groups you then add the users who shall have the grants defined by the group.

A good practice is to create groups that resembles the professions that work with the robots in your organization. For example, you can create groups for administrators, programmers and operators.

The Default group

All controllers have a default group named *Default Group*, to which all grants are given and to which the default user belongs. This group cannot be removed, but it can be changed by the user having the grant *Manage UAS settings*.

Continues on next page



Note

There is a risk changing the group membership of the default user. If you by mistake clear the *Default User* check box or any *Default Group* grant, you will get a warning. Make sure that there is at least one user defined that has the grant *Manage UAS settings*. If the *Default group* and no other group have the grant *Manage UAS settings*, you may lose your ability to manage users and groups.

Grants

Grants are permissions to perform actions or access data on the controller. You use the grants by giving them to groups, to which you then add the users who shall have the grants.

Grants may be either *controller grants* or *application grants*. Depending on the actions that you will perform, you may need several grants. For procedures, see [UAS Grant Viewer on page 428](#).

Controller grants

Controller grants are validated by the robot controller and apply to all tools and devices accessing the controller.

Application grants

Application grants are used by a specific application, for example the FlexPendant, and will only be valid using that application. Application grants can be added by add-ins and used in customer applications.

Local and remote clients

RobotStudio normally acts as a remote client of the controller and a device connected to the FlexPendant connector on the controller acts as a local client. The privileges of a remote client is restricted when the controller is in manual mode when compared to a local client, for example, a remote client cannot start program execution or set the program pointer.

RobotStudio as local client

RobotStudio can act as a local client thereby can get full access to the controller functionality without restrictions in manual mode. When you select the **local client** checkbox in the **Add controller** dialog or in the **Login** dialog you can get local client privileges by pressing the enabling switch on the safety device twice, for example, the FlexPendant, JSHD4, or the T10.

6 Working online

6.4.1 About System Builder

6.4 The System Builder

6.4.1 About System Builder

Overview

This section describes how you create, build, modify and copy systems to run on virtual and real controllers. These systems may even be converted to boot media and downloaded to a real controller.

The system points out the robot models and options to use; it also stores configurations and programs for the robots. Therefore, it is good practice to use a unique system for each station even if the stations use the same basic setup. Otherwise, changes in one station may accidentally overwrite data used in another station.



Note

Use System Builder to create and modify systems based on RobotWare 5.xx. Use Installation Manager to create and modify systems with RobotWare versions 6.0 and later, see [The Installation Manager on page 183](#).

About virtual and real systems

The system you run on virtual controllers can either be a real system built on real RobotWare keys or a virtual system built on virtual keys.

When using real systems, the RobotWare keys define which options and robot models shall be used, thus helping you to configure the system correctly. Real systems can be run both on virtual controllers and real IRC5 controllers.

When using virtual keys, all options and robot models are available, which is useful for evaluation purposes, but requires more configuration when creating the system. Systems built on virtual keys can only be run on virtual controllers.

Prerequisites

Creating a system entails applying a predefined template to a station, reusing an existing system or letting RobotStudio propose a system based on a layout.

To create a system, the following conditions must be met:

- The RobotWare media pool must be installed on your PC.
- You must have a RobotWare key for the system, if creating a system to run on a real controller. The RobotWare key is a license key that determines which robot models to use and which RobotWare options to run on the controller. The license key is delivered with the controller.
- If you want to create a system for virtual use only, you can use a virtual key instead. Virtual keys are generated by the wizard. When using virtual keys, you select the robot models and options to use in the *Modify Options* section of the wizard.
- Downloading to the real controller requires a direct connection from your computer to the service or Ethernet port of the controller.

Continues on next page

Administering systems

Systems can be administered from the **System Builder** dialog box in the following ways:

- View system properties, see [Viewing system properties on page 166](#).
- Build a system, see [Building a new system on page 167](#).
- Modify or delete a system, see [Modifying a system on page 171](#).
- Copy a system, see [Copying a system on page 175](#).
- Create a system from backup, see [Creating a system from backup on page 176](#).
- Download a system to a controller, see [Downloading a system to a controller on page 177](#).
- Create boot media, see [Creating boot media on page 178](#).

6.4.2 Viewing system properties

Overview

All systems you create with the System Builder are stored locally on your computer. It is recommended that you store them in one or more dedicated system directories.

Viewing system properties

To view system properties and add comments, follow these steps:

- 1 In the **System Builder** dialog box, select a system from the **Systems** box.
If necessary, in the **System directory** list, you can navigate to the folder in which your systems are stored
- 2 The system properties are then displayed in the **System Properties** box. Optionally, type a comment in the **Comments** box, and click **Save**.

6.4.3 Building a new system

Overview

The **New Controller System Wizard**, used for building a new system, is launched from the System Builder.

Starting the wizard

To start the wizard, follow these steps:

- 1 Click **System Builder** to bring up a dialog box.
 - 2 In the **Actions** group, click **Create New**. This starts the wizard.
 - 3 Read the information on the welcome page and click **Next**.
-

Specifying the name and location

To determine where on your computer to store the system you are creating, follow these steps:

- 1 In the **Name** box, enter a name for the system you are creating.
 - 2 In the **Path** box, enter the path to the system directory in which you will store the system.
You can also click the **Browse** button and browse to the system directory.
 - 3 Click **Next**.
-

Entering the RobotWare keys

The RobotWare keys determine which RobotWare versions and parts to use in the system.

Creating a system to run on either IRC5 controllers or virtual controllers requires at least two keys: one for the controller module and one for each drive module in the cabinet. The keys are delivered together with the controller.

For creating a system to run on virtual controller only (for example, in Virtual IRC5), you can use virtual keys. Virtual keys give access to all options and robot models, but limits the use of the system to virtual controllers only.

To enter the key for the controller module, follow these steps:

- 1 In the **Controller Key** box, enter the controller key. You can also click **Browse** and browse to the key file. If creating a system for virtual use only, select the **Virtual Key** check box, and the controller key will be generated by the wizard.
- 2 In the **Media Pool** box, enter the path to the media pool. You can also click **Browse** and browse to the folder.system
- 3 In the **RobotWare Version** list, select which version of the RobotWare you want to use. Only RobotWare versions that are valid for the used key are available.
- 4 Click **Next**.

Continues on next page

6 Working online

6.4.3 Building a new system

Continued

Entering the drive keys

To enter the keys for the drive modules:

- 1 In the **Drive Key** box, enter the key for the drive module. You can also click the **Browse** button and browse to the key file. If you used a virtual controller key, a virtual drive key is already generated by the wizard.
- 2 Click the right arrow button next to the **Drive Key** box. The key now appears in the **Added drive keys** list.

For real systems the drive key determines the connected robot model. For virtual systems you select the robot model in the *Modify Options* page. The default model is IRB140.

- 3 If you have a MultiMove system, repeat steps 1 and 2 for each drive key to add.

If you have a MultiMove system, make sure that the keys are numbered in the same way as their corresponding drive modules are connected to the controller module. Use the up and down arrows to rearrange the drive keys, if necessary.

- 4 If you want to create the system as it is now, click **Finish**.

If you want to modify options, or add options, parameter data or additional files to the home directory, click **Next**.

Adding additional options

Here you can add options, such as external axes and dispense applications, that are not included in the basic system. Options require a license key and must be first imported to the media pool. To add additional options, follow these steps:

- 1 In the **Key** box, enter the option key. You can also click the **Browse** button and browse to the option's key file.
- 2 Click the **Arrow** button.

The option that the key unlocks is now displayed in the **Added Options** list.



Note

If several versions of an additional option exists, only the latest version can be selected. To use an older version, remove the other versions of the additional option from the Mediapool.

System Builder can modify a system only when all referenced additional options and RobotWare mediapool are placed in the same folder. It is not possible to modify a system that uses a mediapool embedded in a Pack and Go file. You must copy the mediapool to a common mediapool folder and create a system from backup.

- 3 Repeat steps 1 and 2 for all options you want to include.
- 4 Choose whether you want to create the system as it is now, or to continue with the wizard.

If you want to create the system as it is now, click **Finish**.

Continues on next page

If you want to modify options, or add parameter data or additional files to the home directory, click **Next**.

Modifying options

Here you can set up and configure the options in your system. For virtual systems, you also select the robot models to use. To modify any options, follow these steps:

- 1 In the **Option** tree, expand the option folders to the level where you find the option you want to modify.
Only the options unlocked by the used keys are available.
- 2 Modify the option.
- 3 Repeat steps 1 and 2 for all options you want to modify.
- 4 Choose whether you want to create the system as it is now, or to continue with the wizard.

If you want to create the system as it is now, click **Finish**.

If you want to add parameter data or additional files to the home directory, click **Next**.

Adding parameter data

Parameter data is stored in the parameter data files (.cfg files). Each parameter topic has its own parameter file. You can add only one parameter file for each topic. To add parameter data, follow these steps:

- 1 In the **Parameter data** box, enter the path to the folder for the parameter data files. You can also click the **Browse** button and browse to the folder.
- 2 In the list of parameter data files, select the file you want to include and press the **Arrow** button. Repeat for all files you want to include.

The included parameter data files will now appear in the **Added parameter data files** list.

Repeat steps 1 and 2 for each parameter data file you want to add.

- 3 Choose whether you want to create the system as it is now, or to continue with the wizard.

If you want to create the system as it is now, click **Finish**.

If you want to add additional files to the home directory, click **Next**.

Adding files to the home directory

You can add any type of file to the system's home directory. When the system is loaded to a controller, these files will also be loaded. To add files to the system's home directory, follow these steps:

- 1 In the **Files** box, enter the path to the folder for the files you want to include. You can also click the **Browse** button and browse to the folder.
- 2 In the list of files, select the file to add and click the **Arrow** button. Repeat for all files you want to add.

The added files will now appear in the **Added files** list.

- 3 Choose whether you want to create the system as it is now, or to continue with the wizard.

Continues on next page

6 Working online

6.4.3 Building a new system

Continued

If you want to create the system as it is now, click **Finish**.

If you want to read a summary before you create the system, click **Next**.

Completing the New Controller System Wizard

To complete the wizard, follow these steps:

- 1 Read the system summary.
- 2 If the system is OK, click **Finish**.
If the system is not OK, click **Back** and make modifications or corrections.

6.4.4 Modifying a system

Overview

The **Modify Controller System Wizard**, used to modify existing systems, is launched from the System Builder. The wizard helps you with tasks like changing robots, adding and removing external axes and other options. A system that is running must be first shut down before modification.

Starting the wizard

To start the wizard when creating a new station:

- 1 If the system is currently running, on the **Controller** menu, point to **Shutdown** and then click **Shutdown**.
- 2 On the **Controller** menu, click **System Builder** to bring up a dialog box.
- 3 In the **System directory** list, enter or browse to the system directory. Select a system from the list beneath, review the system properties and add and save any comments.
- 4 In the **Actions** group, click **Modify**. This starts the wizard.
- 5 Read the information on the welcome page and click **Next**.

Modifying the program revision

The RobotWare versions that are available for the system are determined by the controller key. The key is essential to the system and cannot be modified.

To use another RobotWare version than the available ones, create a new system with another key.

To optionally modify the program revision, follow the appropriate step or steps:

- 1 To keep the current RobotWare version, select **Yes** and then click **Next**.
- 2 To replace the current RobotWare version, Select **No, replace it..**
- 3 In the **Media pool** box, enter the path to the media pool. You can also click the **Browse** button and browse to the folder.
- 4 In the **New program revision** box, select which version of RobotWare you want to use. Only RobotWare versions that are valid for the RobotWare key are available.
- 5 Click **Next**.

Adding or removing drive keys

The drive key corresponds to the drive modules in your controller. For MultiMove systems, you have one drive module (and one key) for each robot. The keys for your system are delivered together with the controller.

the system is created with a virtual controller key, virtual drive keys are generated by the wizard. when you have added one virtual drive key for each robot, you select which robot to use for each key on the *Modify Options* page.

To optionally add or remove the keys for the drive modules, follow these steps:

- 1 To add a key for a drive module, enter the key in the **Enter Drive Key** box. You can also click the **Browse** button and browse to the key file.

Continues on next page

6 Working online

6.4.4 Modifying a system

Continued

- 2 Click the right arrow button. The key now appears in the **Added drive key** list.
If you have a MultiMove system, repeat steps 1 and 2 for each drive key to add.
- 3 To remove a drive module, select the corresponding key in the **Added drive key** list and click **Remove drive key**.
If you have a MultiMove system, repeat step 3 for each drive key to remove.
- 4 If you have a MultiMove system, make sure that the keys are numbered in the same way as their corresponding drive modules are connected to the controller module. Use the up and down arrows to rearrange the drive keys, if necessary.
- 5 Choose whether you want to create the system as it is now, or to continue with the wizard.
If you want to create the system as it is now, click **Finish**.
If you want to modify options, parameter data or add files to or remove files from the home directory, click **Next**.

Adding or removing additional options

To optionally add or remove additional options:

- 1 To add an add-in, in the **Enter Key** box, enter the option key. You can also click the **Browse** button and browse to the option's key file.
- 2 Click the **Arrow** button.
The option that the key unlocks is now displayed in the **Added Options** list.



Note

If several versions of an additional option exists, only the latest version can be selected. To use an older version, remove the other versions of the additional option from the Mediapool.

- 3 Repeat steps 1 and 2 for all options you want to include.
- 4 To remove an add-in, In the additional options, in the Added options list, select the add-in you want to remove.
- 5 Click **Remove**.
- 6 Choose whether you want to create the system as it is now, or to continue with the wizard.
If you want to create the system as it is now, click **Finish**.
If you want to modify parameter data or add files to or remove files from the home directory, click **Next**.

Modifying options

To optionally modify any options, follow these steps:

- 1 In the **Option** tree, expand the option folders to the level where you find the option you want to modify.
Only the options unlocked by the used keys are available.

Continues on next page

- 2 Modify the option.
- 3 Repeat steps 1 and 2 for all options you want to modify.
- 4 Choose whether you want to create the system as it is now, or to continue with the wizard.

If you want to create the system as it is now, click **Finish**.

If you want to modify parameter data or add files to or remove files from the home directory, click **Next**.

Adding or removing parameter data

Parameter data is stored in the parameter data files (.cfg files). Each parameter topic has its own parameter file. You can add only one parameter file for each topic. To add or remove parameter data, follow these steps:

- 1 To add parameter data, in the **Parameter data** box, enter the path to the folder for the parameter data files. You can also click the **Browse** button and browse to the folder.
- 2 In the list of parameter data files, select the file you want to include and press the **Arrow** button. Repeat for all files you want to include.

The included parameter data files will now appear in the **Added parameter data files** list.

Repeat steps 1 and 2 for each parameter data file you want to add.

- 3 To remove parameter data, in the **Added parameter data files** list, select the parameter data file to remove.
- 4 Click **Remove**.
- 5 Choose whether you want to create the system as it is now, or to continue with the wizard.

If you want to create the system as it is now, click **Finish**.

If you want to add to or remove files from the home directory, click **Next**.

Add files to or remove files from the home directory

You can add any type of file to the system's home directory, or remove files from it. When the system is loaded to a controller, these files will also be loaded. To optionally add files to or remove files from the system's home directory, follow these steps:

- 1 To add files, in the **Files** box, enter the path to the folder for the files you want to include. You can also click the **Browse** button and browse to the folder.
- 2 In the list of files, select the file to add and click the **Arrow** button. Repeat for all files you want to add.

The added files will now appear in the **Added files** list.

- 3 To remove files, in the **Added files** list, select the file to remove.
- 4 Click **Remove**.
- 5 Choose whether you want to create the system as it is now, or to continue with the wizard.

If you want to create the system as it is now, click **Finish**.

Continues on next page

6 Working online

6.4.4 Modifying a system

Continued

If you want to read a summary before you create the system, click **Next**.

Complete the Modify Controller System wizard

To complete the wizard, follow these steps:

- 1 Read the system summary.
- 2 If the system is OK, click **Finish**.

If the system is not OK, click **Back** and make modifications or corrections.

Result

Modifications will take effect when the wizard is completed.

If the system has been downloaded to a controller, it must be downloaded again before the modifications will take effect on the controller.

If the system is used by a VC, restart the controller using the restart mode **Reset controller** for the changes to take effect.

Deleting a system

To delete a system, follow this steps:

- 1 From the **System Builder** dialog box, select the system and then click **Delete**.

6.4.5 Copying a system

Copy a system

To copy a system, follow these steps:

- 1 From the **System Builder** dialog box, select the system and then click **Copy** to bring up a dialog box.
- 2 Enter a name for the new system and a path, and then click **OK**.

6.4.6 Creating a system from backup

Overview

The **Create System from Backup Wizard**, which creates a new system from a controller system backup, is launched from the System Builder. In addition, you can change the program revision and options.

Starting the wizard

To start the wizard, follow these steps:

- 1 From the **System Builder** dialog box, click **Create from Backup**. This starts the wizard.
 - 2 Read the information on the welcome page and click **Next**.
-

Specifying the name and location

To specify the destination folder, follow these steps:

- 1 In the **Name** box, enter a name for the system you are creating.
 - 2 In the **Path** box, enter the path to the system directory in which you will store the system.
You can also click the **Browse** button and browse to the system directory.
 - 3 Click **Next**.
-

Locating the backup

To locate a system from backup, follow these steps:

- 1 In the **Backup folder** box, enter the path to the backup folder. Alternatively, click the **Browse** button to browse to it. Click **Next**.
- 2 In the **Media Pool** box, enter the path to the media pool containing the appropriate RobotWare program. Confirm the backup information that now appears in the wizard. Click **Next**.

6.4.7 Downloading a system to a controller

Overview

All systems you access from the System Builder are stored on your computer. If you wish to run a system on a robot controller, you must first load it to the controller, which then requires a restart.

Load a system

To load a system to a controller, follow these steps:

- 1 From the System Builder dialog box, select a system and then click **Download to Controller** to bring up a dialog box.



Note

Systems with incompatible hardware versions will not be displayed in the **Download to Controller** dialog box.

- 2 Specify the Destination Controller for the system.

You can select by using the...	if...
Select controller from list option	the controller has been detected automatically.
Specify IP address or controller name option	your PC and the robot is connected to the same network. You can only use the controller name in DHCP networks.
Use service port option	your PC is directly connected to the controller's service port.

- 3 Optionally, click **Test Connection** to confirm that the connection between the computer and the Controller is OK.
- 4 Click **Load**.
- 5 Answer **Yes** to the question **Do you want to restart the controller now?**

Yes	The controller restarts immediately and the downloaded system starts automatically.
No	The controller does not restart immediately. To start using the downloaded system, you have to: <ol style="list-style-type: none"> a Restart the controller using the restart mode Start Boot Application. b select the system manually
Cancel	The downloaded system is removed from the controller.

6 Working online

6.4.8 Creating boot media

6.4.8 Creating boot media

Overview

Boot media is an entire system which the System Builder packs to a single file and commonly stores on a hard disk or USB memory. The controller then accesses the file through its Ethernet port or USB port, respectively.

Creating boot media

To create boot media, follow these steps:

- 1 From the **System Builder** dialog box, create a new system. For creating a new system, see [Building a new system on page 167](#).
 - 2 From the **System Builder** dialog box, select a new system or an existing system and then click **Boot Media**.
 - 3 In the **Path** box, enter the path to the folder where you want to store the boot media file. Alternatively, browse to the location.
 - 4 Click **OK**.
-

Result

To load the boot media system to a controller, first connect it and then restart the controller using the restart mode **Start Boot Application**.

6.4.9 Examples using the System Builder when offline

6.4.9.1 A system with support for one robot and one positioner external axis

Overview

In this example we will use the System Builder to create an offline system to use in a new RobotStudio station with one IRB1600 robot and one IRBP 250D positioner external axis.

Prerequisites

When creating systems for positioner external axes, you need the media pool and the license key file for that specific positioner. In this example we will use a media pool and license key file for a demo positioner.

Paths to files and folders assume that RobotStudio and the RobotWare media pool have been installed at their default locations on Windows XP. If not, adjust the paths accordingly.

Starting the New Controller System Wizard

To create a system like the one described above, follow these steps:

- 1 Click **System Builder** to bring up a dialog box.
 - 2 In the dialog box, click **Create New** to bring up the **New Controller System Wizard**.
 - 3 Read the welcome text, and click **Next** to continue to the next page.
-

Entering the controller key

- 1 Select the **Virtual key** check box. A virtual controller key now appears in the Controller Key box. In this example we will use the default media pool and RobotWare version.
 - 2 Click **Next** to continue to the next page.
-

Entering drive keys

- 1 Click the **Right Arrow** button next to the **Enter Drive key** box to create one drive key for the robot.
 - 2 Click **Next** to continue to the next page.
-

Adding options

This is where we point out the key file for the positioner.

- 1 Next to the **Enter key** box, click the browse button and select the key file.
-

Continues on next page

6 Working online

6.4.9.1 A system with support for one robot and one positioner external axis

Continued

In this example, browse to and select the file *extkey.kxt* in the folder
C:\Program Files\ABB Industrial IT\Robotics
IT\MediaPool\3HEA-000-00022.01.



Tip

In the *MediaPool* folder media pools for several standard positioners are installed. They are named by the positioner's article number, with a suffix that indicates if it is configured for single-robot or MultiMove systems.

- 2 Click the *Right Arrow* button next to the **Enter key** box to add the key for the positioner.
- 3 Click **Next** and continue to the next page of the wizard.

Modifying options

When creating robot systems from real robot keys, the key sets the options. But since we are using a virtual key, we have to set the options manually. To set the options necessary for a positioner, follow these steps:

- 1 Scroll down to the **RobotWare / Hardware** group and select the **709-x DeviceNet** check box.
This option is for the communication between the controller and the track external axis.
- 2 Scroll down to the **DriveModule1 / Drive module application** group and expand the **ABB Standard manipulator** option. Select the **IRB 1600** option.
This option sets the robot to an IRB 1600-5/1.2.
- 3 Scroll down to the **DriveModule1 > Drive module configuration** group; select the **Drive System 04 1600/2400/260** option; expand the **Additional axes drive module** group and select the **R2C2 Add drive** option.
 - a Expand the **Drive type in position Z4** group and select the **753-1 Drive C in pos Z4** option
 - b Expand the **Drive type in position Y4** group and select the **754-1 Drive C in pos Y4** option
 - c Expand the **Drive type in position X4** group and select the **755-1 Drive C in pos X4** option

Continues on next page

6.4.9.1 A system with support for one robot and one positioner external axis *Continued*

This option adds drive modules for the positioner axes.



Note

When using the latest drive system, do the following:

Scroll down to the **DriveModule1 > Drive module configuration** group; select the **Drive System 09 120/140/1400/1600 Compact** option; expand the **Power supply configuration** group and select **1-Phase Power supply** or **3-Phase Power supply** (as applicable) > **Additional axes drive module > Additional drive**

- a Expand the **Drive type in position X3** group and select the **Drive ADU-790A in position X3** option
- b Expand the **Drive type in position Y3** group and select the **Drive ADU-790A in position Y3** option
- c Expand the **Drive type in position Z3** group and select the **Drive ADU-790A in position Z3** option

- 4 Click **Finish** and the system will be created. When starting the system in a RobotStudio station, you have to set up the system to load a model for the positioner and to get the motions to work properly. See [Placing external axes on page 102](#) for more information.

6.4.9.2 Options settings for systems with positioners

Overview

This is an overview of the RobotWare options to set when creating a system for positioner external axes. Note that besides setting the RobotWare options, you must add an additional option key for the positioner.

Media pools and option keys for the positioners

If you have the media pool and option key for your positioner, you can use these files.

If not, media pools for standard positioners are installed with RobotStudio. The path to these media pools in a default installation is: *C:\program files\ABB Industrial IT\Robotics IT\MediaPool*. In this folder a media pool for each positioner is located. These are named by the article number of the positioner, with a suffix that indicates if it is configured for a single-robot or a MultiMove system.

In the **Additional option** page of the **System Builder**, you should add the option for the positioner by opening the mediapool folder for the positioner to add and selecting the *extkey.kxt* file.

Options for positioners in single-robot systems

When adding a positioner to a single-robot system, the positioner will be added to the same task as the robot. Below, the options to set on the **Modify Options** page of the **System Builder** for such a system are listed:

- **RobotWare > Hardware > 709-x DeviceNet > 709-1 Master/Slave Single**
- Optionally, for using the system with ArcWare also add **RobotWare > Application arc > 633-1 Arc**
- **DriveModule 1 > Drive module configuration > Drive System 04 1600/2400/260 > RC2C Add drive > 753-1 Drive C in pos Z4 > 754-2 Drive T in pos Y4 > 755-3 Drive U in pos X4**

Options for positioners in MultiMove robot systems

When adding a positioner to a MultiMove robot system, the positioner shall be added to a task of its own (thus you also have to add a drive key for the positioner). Below, the options to set on the **Modify Options** page of the **System Builder** for such a system are listed:

- **RobotWare > Hardware > 709-x DeviceNet > 709-1 Master/Slave Single**
- **RobotWare > Motion coordinated part 1 > 604-1 MultiMove Coordinated**
Optionally, expand the MultiMove Coordinated option and select process options for the robots.
- Optionally, for using the system with ArcWare, add **RobotWare > Application Arc > 633-1 Arc**
- **DriveModule 1 > Drive module configuration > Drive System 04 1600/2400/260 > RC2C Add drive > 753-1 Drive C in pos Z4 > 754-2 Drive T in pos Y4 > 755-3 Drive U in pos X4**. For the other drive modules, no additional axes should be configured.

6.5 The Installation Manager

6.5.1 About Installation Manager

Overview

This section describes how to create, modify, and copy systems to run on real and virtual controllers using the Installation Manager.



Note

Use Installation Manager to create and modify systems with RobotWare versions 6.0 and later. Use System Builder to create and modify systems based on earlier versions of RobotWare, see [The System Builder on page 164](#).

About real and virtual systems and license files

When using real license files to create a system, the license files contain the options that the user has ordered, and in most cases no additional configuration is required. Real license files can both be used to create real systems and virtual systems.

When using virtual license files to create a system, all options and robot models are available, which is useful for evaluation purposes, but requires more configuration when creating the system. Virtual license files can only be used to create virtual systems.

Products

Product is the collective name for the different software such as RobotWare, RobotWare add-ins, third party software and so on. Products are either free or licensed, licensed products require a valid license file.

Deployment packages and the repository

Installation Manager can be used to produce an installation or update package offline on a USB-stick, which later can be installed from the FlexPendant. The repository is the storage where all files needed to create and modify RobotWare systems are placed.

For information on using the repository and creating deployment packages, see *Operating manual - IRC5 Integrator's guide*.

Prerequisites

The following are the prerequisites for creating a system:

- A RobotWare license file for the system, when creating a system to run on a real controller. The license file is delivered with the controller.
 - A virtual license file for creating a system for virtual use. All products are delivered with a virtual license file.
 - Installing on a real controller requires a connection from the computer to the service or Ethernet port of the controller.
-

6.5.2 Startup and settings

Starting Installation Manager

On the **Controller** tab, in the **Configuration** group click **Installation Manager** to start the **Installation Manager** application.

This window provides two options. Select **Network** to create systems for real controllers and **Virtual** to create systems for virtual controllers.

Setting application preferences

Before creating a system using Installation Manager, it is recommended to set the path to the desired location where products, licenses, and backups are located and where virtual systems will be created.

- 1 On the **Controller** tab, in the **Configuration** group click **Installation Manager**.
- 2 In the **Installation Manager** window, click **Preferences**. The **Preferences** window opens.
- 3 Browse and select folders for **Product path(s)**, **License path(s)**, **Virtual systems path(s)**, and **Backup path(s)** in respective lists.

The **User name** and **Password** boxes are populated with the default credentials provided to you with your RobotStudio license. These credentials are applicable only for a real controller.

- 4 In the **Default System Name** box, enter the default system name. When you create a new system, this name will be assigned by default.
- 5 Click **OK** to set the preferences.

Advanced users can select the location to install virtual controllers. Select the **Virtual products installation path(s)** check box and then click **Browse** to select the folder. You can see the selected path in the drop-down list box. Clear the check box to enable the default path.

For information on using the repository and creating deployment packages, see *Operating manual - IRC5 Integrator's guide*.

Settings file

Settings file contains the selected options. When Installation Manager connects to a system, it reads options from the Settings file. Any change in the options are mapped in the file.

Use the **Settings** buttons to perform the following tasks with the settings file.

Buttons	Description
Export settings	Click this button to export the current settings of the system.
Import settings	Click this button to import settings to the system. The current settings of the system will be cleared before performing this operation.
Add settings	Click this button to add settings to the current setup of the system.
Revert	Click this button to revert to the current settings of the system.

6.5.3 Building a new system

Creating a new system for a real controller

- 1 In the **Installation Manager** window, click **Controllers**, and then click the **Network** tab.

The **Network** tab shows the name and IP address of all the available controllers on the LAN network and/or any controller attached through the service port.

- 2 Select your controller in the controller list and click **Open**. Installation Manager fetches information from the controller.
- 3 Click **New**. The **Create New** pane appears.
- 4 In the **Create New** pane, in the **Name** box, enter the name of the new system.
- 5 Click **Next**. The **Products** tab gets selected.
- 6 Click **Add**, the **Select Product** window opens. Select the product manifest file and click **OK**.

If you want to add more products such as Add-ins, click **Add** again and select the product. To find a product that is not in the list, click **Browse** and then select the file from the particular folder.

- 7 Click **Next**. The **Licenses** tab gets selected.
- 8 Click **Add**, the **Select License** window opens. Select the license file and click **OK**.

Repeat the step to add multiple license files to your system.

- 9 Click **Next**, the **Options** tab gets selected. This pane shows the **System Options**, **Drive Modules** and **Applications**. Here you are able to customize your options.
- 10 Click **Next**, the **Confirmation** tab gets selected and shows an overview of the system options.
- 11 Click **Apply**, the system gets created on the controller.

Once the installation completes, a **Restart Controller** dialog appears, click **Yes** to restart the controller. Click **No** to manually restart controller later, the controller stores the new system or the changed system and these changes will take effect during the next restart.



Note

Changing the RobotWare version needs BootServer update. Controller must be restarted for BootServer update. Hence, the controller will be restarted automatically when you change the RobotWare.

Creating a new system for a virtual controller

- 1 In the **Installation Manager** window, click **Controllers**, and then click the **Virtual** tab.
- 2 Click **New**. The **Create New** pane opens.
- 3 In the **Create New** pane, in the **Name** box, enter the name of the new system.

Continues on next page

6 Working online

6.5.3 Building a new system

Continued

- 4 Click **Next**. The **Products** tab gets selected.
- 5 Click **Add**, the **Select Product** window opens. Select the product manifest file and click **OK**.
If you want to add more products such as Add-ins, click **Add** again and select the product. To find a product that is not in the list, click **Browse** and then select the file from the particular folder.
- 6 Click **Next**. The **Licenses** tab gets selected.
- 7 Click **Add**, the **Select License** window opens. Select the license file and click **OK**.
Repeat the same step to add multiple license files to your system.
- 8 Click **Next**, the **Options** tab gets selected. This pane shows the **System Options, Drive Modules and Applications**. Here you are able to customize your options.
- 9 Click **Next**, the **Confirmation** tab gets selected and shows an overview of the system options.
- 10 Click **Apply**, the system gets created.

6.5.4 Modifying a system

Modifying a system for a real controller

- 1 In the **Installation Manager** window, select **Controllers** and then select the **Network** tab.
- 2 Select your controller in the controller list and click **Open**. Installation Manager fetches information from the controller.
- 3 Select the particular system that you want to modify.

The **Overview** pane displays the system options of the selected system.



Note

To be able to modify a system it must first be activated. Select the system you want to modify and press the activate button.

- 4 Click **Next**. The **Products** tab gets selected. All products and add-ins that were part of the selected system will be displayed here.
 - To upgrade/downgrade a product select the product and click **Replace**.
 - To remove a product select the product and click **Remove**.



Note

It is not possible to remove the RobotWare product.

- 5 Click **Next**. The **Licence** tab gets selected. The license details of the selected system will be displayed here. Here you are able to add/remove licenses.
- 6 Click **Next**. The **Options** tab gets selected. Here you are able to customize your options.
- 7 Click **Next**, the **Confirmation** tab gets selected and shows an overview of the system options.
- 8 Click **Apply** for the changes to take place.

Once the installation completes, a **Restart Controller** dialog appears, click **Yes** to restart the controller. Click **No** to manually restart controller later, the controller stores the new system or changed system and these changes will take effect during the next restart.



Note

Any change in the RobotWare version needs a BootServer update, which requires a controller restart. The controller will be restarted automatically.

Modifying a system for virtual controller

- 1 In the **Installation Manager** window, select **Controllers** and then select the **Virtual**. Here you are able to view the list of all virtual systems.
- 2 Select the particular system that you want to modify.

The **Overview** pane will display the system options of the selected system.

Continues on next page

6 Working online

6.5.4 Modifying a system

Continued

- 3 Click **Next**. The **Products** tab gets selected. All products and add-ins that were part of the selected system will be displayed here.
 - To upgrade/downgrade a product select the product and click **Replace**.
 - To remove a product select the product and click **Remove**.



Note

It is not possible to remove the RobotWare product.

- 4 Click **Next**. The **Licence** tab opens. The license details of the selected system will be displayed here. Here you are able to add/remove licenses.
- 5 Click **Next**. The **Options** tab opens. This pane shows the **System Options**, **Drive Modules** and **Applications**. Here you are able to customize your options.
- 6 Click **Next**, the **Confirmation** tab gets selected and shows an overview of the system options.
- 7 Click **Apply** for the changes to take place.

Deleting a system from a real controller

- 1 In the **Installation Manager** window, select **Controllers** and then select the **Network** tab.
- 2 Select your controller in the controller list and click **Open**. Installation Manager fetches information from the controller.
- 3 Select the system you want to delete and then click **Remove**.
The selected system gets deleted.



Note

The active system cannot be deleted. First activate a different system, or deactivate the system by using the restart mode **Start Boot Application**.

Deleting a system from virtual controller

- 1 In the **Installation Manager** window, select **Controllers** and then select the **Virtual** or **Network** tab. Here you are able to view the list of all virtual systems.
- 2 Select the system you want to delete and then click **Remove**.
The selected system gets deleted.



Note

When you create a system for virtual controller, corresponding products are installed in the user APPDATA folder, and many virtual controller systems point to these products. Hence, products are not deleted while deleting a system from virtual controller.

6.5.5 Copying a system

Copying a system from a virtual controller to a real controller

To be able to copy a system from a virtual controller to a real controller, the virtual controller system must have been created with real license files.

- 1 In the **Installation Manager** window, select **Controllers** and then select the **Network** tab.
- 2 Select your controller in the controller list and click **Modify**. Installation Manager fetches information from the controller.
- 3 Click **New**. The **Create New** pane opens.
- 4 Enter the name of the system in the **Name** box, and then click the **virtual system** option under **Create new from**.
- 5 Click **Select**, the **Select Virtual System** pane opens, select the particular system and then click **OK**.
- 6 Click **Next**. The **Products** tab gets selected. All products and add-ins that were part of the selected system will be displayed here.
- 7 Click **Next**. The **Licenses** tab gets selected. The license details of the selected system will be displayed here.
- 8 Click **Next**. The **Options** tab gets selected. Here you are able to select/deselect options to customize them.
- 9 Click **Next**, the **Confirmation** tab gets selected and shows an overview of the system options.
- 10 Click **Apply**, the system gets created.

Once the installation completes, a **Restart Controller** dialog appears, click **Yes** to restart the controller. Click **No** to manually restart controller later, the controller stores the new system or changed system and these changes will take effect during the next restart.

Copying a virtual controller system

- 1 In the **Installation Manager** window, select **Controllers** and then select the **Virtual** tab. Here you are able to view the list of all virtual systems.
- 2 Click **New**, the **Create New** pane opens.
- 3 Enter the name of the virtual system in the **Name** box, and then click the **virtual system** option under **Create new from**.
- 4 Click **Select**, the **Select Virtual System** pane opens, select the particular system and then click **OK**.
- 5 Click **Next**. The **Products** tab gets selected. All products and add-ins that were part of the selected system will be displayed here.
- 6 Click **Next**. The **Licence** tab gets selected. The license details of the selected system will be displayed here.
- 7 Click **Next**. The **Options** tab gets selected. Here you are able to select/deselect options to customize them.
- 8 Click **Next**, the **Confirmation** tab gets selected and shows an overview of the system options.

Continues on next page

6 Working online

6.5.5 Copying a system

Continued

- 9 Click **Apply** for the changes to take place.

6.5.6 Creating a system from backup

Creating a system from backup for a real controller

- 1 In the **Installation Manager** window, select **Controllers** and then select **Network** tab.
- 2 Select your controller in the controller list and click **Open**. Installation Manager fetches information from the controller.
- 3 Click **New**, the **Create New** pane opens.
- 4 Enter the name of the system in the **Name** box, and then click **backup** option under **Create new from**.
- 5 Click **Select**, the **Select Backup** pane opens, you can select the particular backup system and then click **OK**. If the right RobotWare already exists, then the version will be selected.



Note

In the folder hierarchy of the backup path, the name of the valid backup system folder that must be selected will be set in bold. Similarly, names of all valid backup systems will be marked in bold in the folder hierarchy. User must select one of the valid backup folders for further system creation.

- 6 Click **Next**. The **Products** tab gets selected. All products and add-ins that were part of the backup system will be displayed here. You can add new/other product(s) and/or replace RobotWare version if needed.
- 7 Click **Next**. The **Licenses** tab gets selected. The license details of the backup system will be displayed here. You are able to view the license(s) from the backup system. Here you can add new/more licenses.
- 8 Click **Next** the **Options** tab gets selected, select/deselect options to customize them.
- 9 Click **Next**, the **Confirmation** tab gets selected and shows an overview of the system options.
- 10 Click **Apply**, the system gets created.
Once the installation completes, a **Restart Controller** dialog appears, click **Yes** to restart the controller. Click **No** to manually restart controller later, the controller stores the new system or changed system and these changes will take effect during the next restart.

Creating a system from backup for a virtual controller

- 1 In the **Installation Manager** window, select **Controllers** and then select the **Virtual** tab. Here you are able to view the list of all virtual systems.
- 2 Click **New**, the **Create New** pane opens.
- 3 Enter the name of the system in the **Name** box, and then click **backup** option under **Create new from**.
- 4 Click **Select**, the **Select Backup** pane opens, you can select the particular backup system and then click **OK**.

Continues on next page

If the right RobotWare already exists, then the version will be selected. If the RobotWare does not exist, click **Replace** to select the RobotWare.



Note

In the folder hierarchy of the backup path, the name of the valid backup system folder that must be selected will be set in bold. Similarly, names of all valid backup systems will be marked in bold in the folder hierarchy. User must select one of the valid backup folders for further system creation.

- 5 Click **Next**. The **Products** tab gets selected.
All products and add-ins that were part of the backup system will be displayed here. You can add new/other product(s) and/or replace RobotWare if needed.
- 6 Click **Next**. The **Licenses** tab gets selected. Here you are able to view the license details of the backup system.
- 7 Click **Next**, the **Options** tab gets selected, select/deselect options to customize them.
- 8 Click **Next**, the **Confirmation** tab gets selected and shows an overview of the system options.
- 9 Click **Apply**, the system gets created.

6.5.7 Renaming a system

Renaming a system

You can rename an active system for a real controller without re-installation.

- 1 In the **Installation Manager** window, select **Controllers** and then select **Network** tab.
- 2 Select the active sytem which must be renamed.
- 3 Click **Rename**. The **Rename System** dialog appears.
- 4 In the **Enter the new name for the system** box, type in the new name.
- 5 Click **Rename**.

6 Working online

6.5.8 A MultiMove system with two coordinated robots

6.5.8 A MultiMove system with two coordinated robots

Overview

In this example we will use the System Builder to create a coordinated offline system with one IRB2400 and one IRB1600 robot to use in a new RobotStudio station.

Starting the New Controller System Wizard

To create a system like the one described above, follow these steps:

- 1 Click **System Builder** to bring up the dialog box.
 - 2 In the dialog box, click **Create New** to bring up the **New Controller System Wizard**.
 - 3 Read the welcome text, and click **Next** to continue to the next page.
-

Entering the name and path

- 1 In the **Name** box, enter the name of the system. The name must not contain blank spaces or non-ASCII characters.
In this example, name the system *MyMultiMove*.
 - 2 In the **Path** box, enter the path for the folder to save the system in, or click the **Browse** button to browse to the folder or create a new one.
In this example, save the system in *C:\Program Files\ABB Industrial IT\Robotics IT\RobotStudio\ABB Library\Training Systems*.
 - 3 Click **Next** to continue to the next page.
-

Entering the controller key

- 1 Select the **Virtual key** check box. A virtual controller key now appears in the Controller Key box. In this example we will use the default media pool and RobotWare version.
 - 2 Click **Next** to continue to the next page.
-

Entering drive keys

- 1 Click the **Right Arrow** button next to the **Enter Drive key** box twice to create one drive key for each robot.
 - 2 Click **Next** to continue to the next page.
-

Adding options

- 1 This system does not require any additional option keys. Click **Next** and continue to the next page of the wizard.
-

Modifying options

When creating robot systems from real robot keys, the key sets the options. But since we are using a virtual key, we have to set the options manually.

Continues on next page

When creating a system for several manipulators (up to four), you must include either of the RobotWare options **MultiMove Independent**, or **MultiMove Coordinated** for the related motion tasks to start.



Note

It is recommended to use the **System From Layout** function when you create robot systems for RobotStudio. Then the MultiMove option gets added automatically.

To set the options necessary for a MultiMove, follow these steps:

- 1 Scroll down to the **RobotWare / Motion Coordination part 1** group and select the **MultiMove Coordinated** check box.
- 2 Scroll down to the **RobotWare/ Engineering Tools** group and select the **Multitasking** check box.



Note

The option **Advanced RAPID** is included in RobotWare- operating system from RobotWare 5.60 and later.

- 3 Scroll down to the **DriveModule1 / Drive module application** group and expand the **ABB Standard manipulator** option. Select the **IRB 2400 Type A** option, manipulator variant **IRB 2400L Type A**.
- 4 Scroll down to the **DriveModule2 / Drive module application** group and expand the **ABB Standard manipulator** option. Select the **IRB 1600** option, manipulator variant **IRB 1600-5/1.2**.
- 5 Click **Finish** and the system will be created.

6 Working online

6.5.9 The recovery disk function

6.5.9 The recovery disk function

Introduction

The recovery disk function is for recreating a complete installation of RobotWare and Add-Ins directly to a SD-card in the PC. The recovery disk function can be found under both the **Controller** tab and the **Repository** tab in Installation Manager.

Prerequisites

The recovery disk function uses information from a backup to recreate the RobotWare system that backup has been generated from.

For successful operation these prerequisites are needed:

- A backup for a system using RobotWare 6.0 or later, but not later than the version of the currently used RobotStudio.
- All products and Add-Ins used by the backup should be located on the pc (RPK:s and RMF:s).
- A SD-card reader.
- An original ABB Robotics SD-card.
- Administrative rights on the PC.

SD-card creation procedure

- 1 When the disk recovery function is started, the user will be asked to browse for the backup folder. Once a valid backup directory is selected, the **Write Disk** button is active.
- 2 The program will then try to locate all products and add-ins referenced in the selected backup. If one or more product cannot be found, a second directory browser will appear and the user will be asked to manually locate the product that could not be found. The program will remember the parent directory of the selected product, and include this directory in later searches.
- 3 When all products are located, the user will be asked to insert a SD-card into the computer, or if already present the user will first be asked to remove the card. This is to ensure that SD-cards are not overwritten by mistake.
- 4 Once the SD-card is inserted the user is prompted to confirm that the SD-card will be permanently overwritten. From this point on and until the operation is complete, the SD-card will be unusable in any other sense than to be used by the disk recovery function again.
- 5 The operation is completed after about one minute, depending on the SD-card reader performance, and the user is asked to remove the SD-card.

Installation procedure



CAUTION

Always power off the robot controller before changing the SD-card.

- 1 Power off the robot controller.
- 2 Replace the SD-card in the controller with the recovery SD-card.

Continues on next page

- 3 Power on the controller.
- 4 The controller completes the operation by resetting the system to default values.

The text *Controller is resetting system* might appear on the FlexPendant depending on how long this operation takes.

- 5 The RobotWare system starts up.

For RobotWare versions greater or equal to 6.04, the backup selected in the recovery disk creator is automatically restored.

The backup can be found with its original name in the following folder:
/hd0a/BACKUP.

6 Working online

6.6 Handle I/O

6.6 Handle I/O

Overview

The I/O system handles input and output signals to and from the controller. Below are the parts of the system described, as well as common types of signals.

The I/O system window is used to view and set previously configured signals, and to activate and deactivate devices.

The I/O system

The I/O system of a controller consists of industrial networks, devices and I/O signals. The industrial network are the controller's connections for devices (for instance I/O boards) and the devices contain channels for the actual signals.

The industrial networks and devices are displayed in the robot view, as child nodes under each controller and the I/O signals are displayed in the I/O window.

I/O signals

I/O signals are used to communicate between the controller and external equipment, or to change variables within a robot program.

Input signals

Input signals notify something for the controller, for instance a feeder belt can set an input signal when it has positioned a work piece. The input signal can then be programmed to start a specific part of the robot program.

Output signals

The controller uses output signals to notify that a specified condition has been fulfilled. For instance, after the robot has finished its sequence, an output signal can be set. This signal can then be programmed to start a feeder belt, update a counter or trigger any other action.

Simulated signals

A simulated signal is a signal that is manually given a specific value that overrides the actual signal. Thus simulated signals might be useful for testing robot programs without activating or running equipment.

Virtual signals

Virtual signals are signals that are not configured to belong to a physical device. Instead, they reside inside the controller's memory. A common use for virtual signals is to set variables and store changes in a robot program.

Procedures

For using the I/O system window, see [Inputs/Outputs on page 386](#).

For adding a signal, see [Add Signals on page 398](#).

6.7 Configure systems

Configuring system parameters

System parameters may be configured as follows:

- To view topics, types, instances and parameters
- To edit the parameters of an instance
- To copy and paste instances
- To add and delete instances
- To load and save complete configuration files to and from controllers

When working with configurations, the following tools, see [Configuration editor on page 398](#), are useful:

Tool	Use
The Configuration Editor	With the Configuration Editor you work with the types and instances of a specific topic.
The Instance Editor	With the Instance Editor, you specify the values of the parameters in the instances of system parameter types.



Note

To edit system parameters, you must have write access to the controller.

Terms

<i>System parameters</i>	The sum of all parameters that configure the system, these are divided into topics and types.
<i>Topic</i>	A collection of parameters relating to a specific area, and the highest level in the system parameter structure. Examples are Controller, Communication and Motion.
<i>Type</i>	A set of parameters for a specific configuration task. A type can be seen as a pattern describing the construction and properties for the parameters included in the task. For instance, the type <i>Motion System</i> defines which parameters shall be used for configuring a motion system.
<i>Instance</i>	An actualization of a type, an instance is a specific set of parameters with unique values created from a type pattern. In the Configuration Editor, each row in the Instance list is an instance of the type selected in the Type list.
<i>Parameter</i>	A property to set when configuring the robot system.
<i>Configuration file</i>	Contains all public parameters of a specific topic.

Viewing configurations

- 1 To view the topics of a controller, from the **Controller** tab, expand the **Configuration** node for the controller.
All topics in are now displayed as child nodes to the Configuration node.
- 2 To view the types and instances of a topic, double-click the topic node for the topic to view.

Continues on next page

6 Working online

6.7 Configure systems

Continued

The Configuration Editor is now opened, listing all types of the topic in the **Type name** list. In the **Instance** list, each instance of the type selected in the **Type name** list is displayed as row. The parameter values of the instances are displayed in the columns of the instance list.

- 3 To view detailed parameter information for an instance, double-click the instance.

The instance editor now displays the current value, restrictions and limits of each parameter in the instance.

Editing parameters

You can either edit the parameters of one single instance, or you can edit several instances at one time. Editing several instances at one time is useful when you want to change the same parameter in several instances, like when moving signals from one device to another.

- 1 In the **Controller** tab, expand the **Controller** and the **Configuration** node and double-click the topic that contains the parameters to edit.

This opens the Configuration Editor.

- 2 In the **Type name** list of the Configuration Editor, select the type that the parameter to edit belongs to.

The instances of the type is now displayed in the Instance list of the Configuration Editor.

- 3 In the **Instance** list, select the instances to edit and press the Enter Key. To select several instances at once, hold down the SHIFT or CTRL key while selecting.

Alternatively, right-click an instance and then click **Edit**.

The Instance Editor is now displayed.

- 4 In the Parameter list of the Instance Editor, select the parameter to edit and change the value of the parameter in the **Value** box.

When editing several instances at one time, the parameter values you specify will be applied to all instances. For parameters that you do not specify any new value, each instance will keep its existing value for that parameter.

- 5 Click **OK** to apply the changes to the configuration database of the controller.

For many parameters, the changes will not take affect until the controller is restarted. If your changes require a restart, you will be notified of this.

You have now updated the controller's system parameters. If you are going to make several changes, you can wait with the restart until all changes are done.

Continues on next page

Adding instances

With the Configuration Editor, you can select a type and create a new instance of it. For example, adding a new instance of the type Signal creates a new signal in the system.

- 1 In the **Controller** tab, expand the **Controller** and the **Configuration** node and double-click the topic that contains the type of which you want to add an instance.

This opens the Configuration Editor.

- 2 In the **Type name** list of the Configuration Editor, select the type of which you want to add an instance.
- 3 On the **Controller** menu, point to **Configuration** and click **Add type** (the word type is replaced by the type you selected previously).

You can also right-click anywhere in the configuration editor and then select **Add type** from the shortcut menu.

A new instance with default values is added and displayed in the **Instance Editor** window.

- 4 If required, edit the values.
- 5 Click **OK** to save the new instance.

The values in the new instance are now validated. If the values are valid, the instance is saved. Otherwise, you will be notified of which parameter values to correct.

For many instances, the changes will not take affect until the controller is restarted. If your changes require a restart you will be notified of this.

You have now updated the controller's system parameters. If the changes require a restart of the controller, the changes will not take affect until you do this. If you are going to make several changes, you can wait with the restart until all changes are done.

Copying an instance

- 1 In the **Controller** tab, expand the **Controller** and the **Configuration** node and double-click the topic that contains the instance to copy.

This opens the Configuration Editor.

- 2 In the **Type name** list of the Configuration Editor, select the type of which you want to copy an instance.
- 3 In the **Instance** list, select one or several instances to copy.

If you select several instances and they don't have the same value for all parameters, these parameters will have no default values in the new instances.

- 4 On the **Controller** menu, point to **Configuration** and click **Copy Type** (the word type is replaced by the type you selected previously).

You can also right-click the instance to copy and then select **Copy Type** from the shortcut menu.

A new instance with the same values as the one you copied is added and displayed in the **Instance Editor** window.

Continues on next page

6 Working online

6.7 Configure systems

Continued

- 5 Change the name of the instance. If required, also edit the other values.
- 6 Click **OK** to save the new instance.

The values in the new instance are now validated. If the values are valid, the instance is saved. Otherwise, you will be notified of which parameter values to correct.

For many instances, the changes will not take affect until the controller is restarted. If your changes require a restart you will be notified of this.

You have now updated the controller's system parameters. If the changes require a restart of the controller, the changes will not take affect until you do this. If you are going to make several changes, you can wait with the restart until all changes are done.

Deleting an instance

- 1 In the **Controller** tab, expand the **Controller** and the **Configuration** node and double-click the topic that contains the type of which you want to delete an instance.

This opens the Configuration Editor.

- 2 In the **Type name** list of the Configuration Editor, select the type of which you want to delete an instance.
- 3 In the **Instance** list, select the instance to delete.
- 4 On the **Controller** menu, point to **Configuration** and then click **Delete type** (the word type is replaced by the type you selected previously).

You can also right-click the instance to delete and then select **Delete type** from the shortcut menu.

- 5 A message box is displayed, asking if you want to delete or keep the instance. Click **Yes** to confirm that you want to delete it.

For many instances, the changes will not take affect until the controller is restarted. If your changes require a restart you will be notified of this.

You have now updated the controller's system parameters. If the changes require a restart of the controller, the changes will not take affect until you do this. If you are going to make several changes, you can wait with the restart until all changes are done.

Save one configuration file

The system parameters of a configuration topic can be saved to a configuration file, stored on the PC or any of its network drives.

The configuration files can then be loaded into a controller. They are thereby useful as backups, or for transferring configurations from one controller to another.

- 1 In the **Controller** tab, expand the **Configuration** node and select the topic to save to a file.
- 2 On the **Controller** menu, point to **Configuration** and select **Save System Parameters**.

You can also right-click the topic and then select **Save System Parameters** from the shortcut menu.

Continues on next page

- 3 In the **Save As** dialog box, browse for the folder to save the file in.
- 4 Click **Save**.

Saving several configuration files

- 1 In the **Controller** tab, select the **Configuration** node.
- 2 On the **Controller** menu, point to **Configuration** and click **Save System Parameters**.
You can also right-click the configuration node and then click **Save System Parameters**.
- 3 In the **Save System Parameters** dialog box, select the topics to save to files. Then click **Save**.
- 4 In the **Browse for Folder** dialog box, browse for the folder to save the files in, and then click **OK**.
The selected topics will now be saved as configuration files with default names in the specified folder.

Loading a configuration file

A configuration file contains the system parameters of a configuration topic. They are thereby useful as backups, or for transferring configurations from one controller to another.

When loading a configuration file to a controller, it must be of the same major version as the controller. For instance, you cannot load configuration files from an S4 system to an IRC 5 controller.

- 1 In the **Controller** tab, select the **Configuration** node.
- 2 On the **Controller** menu, point to **Configuration** and select **Load Parameters**.
You can also right-click the configuration node and then select **Load Parameters** from the context menu.
This opens the **Select mode** dialog box.
- 3 In the **Select mode** dialog box, select how you want to combine the parameters in the configuration file to load with the existing parameters:

If you want to	then
replace the entire configuration of the topic with the one in the configuration file.	select Delete existing parameters before loading
add new parameters from the configuration file to the topic, without modifying the existing ones.	click Load parameters if no duplicates
add new parameters from the configuration file to the topic and update the existing ones with values from the configuration file. Parameters that only exist in the controller and not in the configuration file will not be changed at all.	click Load parameters and replace duplicates

- 4 Click **Open** and browse to the configuration file to load. Then click **Open** again.
- 5 In the information box, click **OK** to confirm that you want to load the parameters from the configuration file.

Continues on next page

6 Working online

6.7 Configure systems

Continued

- 6 When the loading of the configuration file is finished, close the Select mode dialog box.

If a restart of the controller is necessary for the new parameters to take affect, you will be notified of this.

6.8 Handle events

Overview

An event is a message that notifies you that something has happened to the robot system, be it merely a change in operation mode or a severe error that calls for your immediate attention. If the event requires any action from you, this is stated in the event.

Events are displayed in the event logs of the FlexPendant and RobotStudio.

The event log keeps you informed of system status, allowing you to:

- view controller events.
- filter events.
- sort events.
- get detailed information about an event.
- save event log files on your PC.
- clear event records.

Event Log list

The event log list consists of all events matching your filter settings, with the following information for each event:

Type	The event type is an indication of the severity of the event.
Code	The event code is a number that identifies the event message.
Title	The event title is a short event description.
Category	The event category is an indication of the source of the event.
Seq. Number	The sequential number indicates the chronological order of the event.
Date and Time	Date and time is when the event occurred.

When you select an event in the list, detailed information will appear to the right.

Event type

The event type is an indication of the severity of the event.

There are three types of events:

Event type	Description
Information	A normal system event, such as starting and stopping programs, change of operating mode, motors on/off and so on. Information messages never require any action from you, but can be useful for error tracking, statistics collecting or monitoring user triggered event routines.
Warning	An event that you need to be aware of, but not so severe that the process or RAPID program needs to be stopped. Warnings, however, often indicate underlying problems that sooner or later must be solved. Warnings must sometimes be acknowledged.
Error	An event that prevents the robot system from proceeding. The running process or RAPID program cannot continue, but is stopped. All errors must be acknowledged. Most errors also require some immediate action from you in order to solve the problem.

Continues on next page

6 Working online

6.8 Handle events

Continued



Note

This information is also indicated by color: blue for information, yellow for warning and red for an error which needs to be corrected in order to proceed

Event code

The event code is a number that identifies the event message. Together with the event date and time each event has a unique identity.

Event title

The event title is a short description of the event.

Event category

The category is an indication of the source of the event.

Category	Display
Common	All recent events.
Operational	Events related to changes in operation or operating mode.
System	Events related to the current system.
Hardware	Events related to controller hardware.
Program	Events related to the running process applications and RAPID programs.
Motion	Events related to the movement of robots or other mechanical units.
I/O & Communication	Events related to input and output signals, serial or network communication and process buses.
User	Custom messages that have been programmed into RAPID programs.
Internal	Internal low-level controller errors for ABB service personnel.
Process	Events related to Industrial Processes options., such as Spot, Arc and Dispense.
Configuration	Errors in a configuration file.
RAPID	Events related to Rapid instruction.

Depending on how the system is configured, additional categories may exist.

Seq number

The sequential number indicates the chronological order of the event; the higher the number the more recently the event occurred.

Date and Time

Date and time indicate exactly when the event occurred. Along with the event code, this timestamp guarantees that each event has a unique identity.

Continues on next page

Event description

When you select an event in the list, detailed description about the selected event is displayed on the right-hand side of the pane which contains a description section, consequences, causes and suggested actions to solve the problem.

Overview

The Event Log automatically logs all controller events once it is started. By default, events are displayed in the chronological order specified by **Seq Numbers**.

**Note**

Any modifications to the list you see will never affect the event log of the controller. What you see is just a copy.

Managing events

- 1 In the Controller browser tree, select a system.
- 2 Double-click the **Event Log** node.

To sort events	Click the header for the column you want to sort by. To switch between ascending and descending sorting, click the header once again.
To filter events	In the Category list select the event category you want to be displayed.
To clear the event log	Click Refresh . This will not affect the event log of the robot controller. It might still be impossible, however, to retrieve all events from a cleared record once again, as the oldest ones may have been erased from the controller hard disk due to lack of space. It is therefore recommended to save the record to a log file before clearing.
To save all events to a single log file on the computer	Select the Log to File check box. If it remains checked, the log file will be updated with new events as they occur.
To save events of one or several categories to files on the computer	Click Save and then make your category choice. Specify the location for the log file(s) in the Save As dialog and then click OK . If you select All when selecting categories, a log file for each event category will be created.

Retrieving controller events

To clear the list and retrieve all existing events from the robot controller:

- 1 Optionally, save the existing Event Log record.
- 2 Select whether you want the list to be updated when new events occur , or if you are only interested in viewing events that have already occurred.

Tothen...
get automatic updates when new events occur	check the Auto Update check box. (Selected by default.)
say no to automatic updates when new events occur	clear the Auto Update check box.

Continues on next page

6 Working online

6.8 Handle events

Continued

- 3 To clear the current list, fetch and display all events that are currently stored in the controller log files.

7 File tab

7.1 Overview

Overview

The File tab opens the RobotStudio Backstage view which displays information and metadata about the currently active station, lists recently opened stations and provides a variety of user options to create a new station, connect to a controller, save station as viewer, and so on.

The the following table shows the various options available in Backstage view.

Tabs	Description
Save / Save As	Saves a station.
Open	Opens a saved station. Select the Load Geometry option when you open or save a station else the geometry gets removed permanently.
Close	Closes a station.
Information	Once a station is open in RobotStudio, this tab shows the properties of the station, and also the robot systems and library files that are part of the open station.
Recent	Displays recently accessed stations.
New	Creates a new station. See New tab on page 211 .
Print	Prints the contents of the active window.
Share	Shares data with others. <ul style="list-style-type: none"> • Pack and Go on page 213 • Unpack and Work on page 214 • Station Viewer on page 215
Online	Connects to a controller. <ul style="list-style-type: none"> • Add Controller on page 382 Imports and Exports controller. Creates and works with robot system. <ul style="list-style-type: none"> • Building a new system on page 167 • Import Options on page 415
Help	Displays information on installing and licensing RobotStudio. See Installing and licensing RobotStudio on page 44 .
Options	Displays information on RobotStudio Options. See Options on page 217 .
Exit	Closes RobotStudio.

RobotStudio Solutions

RobotStudio defines solution as the collective name of the folder that contains the structure for stations, libraries and all related elements. This folder gets created automatically when the user creates a new solution.

You must define the name and location of the solution before creating the folder structure and station.

A solution folder contains the following folders and files:

- 1 Stations: Stations created as part of solution.
- 2 Systems: Virtual controllers created as part of solution

Continues on next page

7 File tab

7.1 Overview

Continued

- 3 Libraries: User-defined libraries that are used in the station.
- 4 Solution file: Opening this file opens the solution.

7.2 New tab

The Backstage view

The **New** tab in Backstage view provides many user options. These options are grouped under the headings **Stations** and **Files**.

The following table provides the details of the options that are grouped under these headings:

Heading	Tabs	Links
Stations	Solution with Empty Station	Creating a solution with an empty station on page 211
	Solution with Station and Robot Controller	Creating a solution with station and robot controller on page 211
	Empty Station	Creating an empty station on page 212
Files	RAPID Module File	Creating a new RAPID module file on page 212
	Controller Configuration File	Creating a controller configuration file on page 212

Creating a solution with an empty station

- 1 Click the **File** tab. The RobotStudio Backstage view appears, click **New**.
- 2 Under **Stations**, click **Solution with Empty Station**.
- 3 Enter the name of the solution in the **Solution Name** box and then browse and select the destination folder in the **Location** box. The default solution path is `C:\User\\Documents\RobotStudio\Solutions`. The solution name will also be used as the name of the included station.
- 4 Click **Create**.
The new solution in the specified name gets created. RobotStudio saves this solution by default.

Creating a solution with station and robot controller

- 1 In the Backstage view, under **Stations**, click **Solution with Station and Robot Controller**.
- 2 Enter the name of the solution in the **Solution Name** box and then browse and select the destination folder in the **Location** box.
The default path of solution `C:\User\\Documents\RobotStudio\Solutions`. If you do not specify the name of the solution, RobotStudio assigns the name *Solution1* by default.
- 3 Under the **Controller** group, enter the name of the controller in the **Name** box or select the robot model from the **Robot Model** list.
The default location of the virtual controller system when name of the solution is not specified is `C:\Users\\Documents\RobotStudio\Solutions\Solution1\System`.
- 4 In the RobotWare list, select the required robotware version or click **Locations** to set the locations of distribution package and media pool.

Continues on next page

7 File tab

7.2 New tab

Continued

- 5 Solution with station and robot controller can be created either from a template or from backup.
 - To create from template, select **Create New** and then select the required robot model from the **Robot Model** list to create a controller.
 - To create from backup, select **Create from backup** and then browse and select the required backup file. Also select the Restore backup check box to restore backup on the new controller.
- 6 Select the option and click **Create**.

Creating an empty station

- 1 In the Backstage view, under **Stations**, click **Empty Station**.
- 2 Click **Create**.

Creating a new RAPID module file

- 1 In the Backstage view, under **Files**, click **RAPID Module File**.
- 2 Choose from the following options:
 - Click **Module (Program Module)** to create a blank RAPID module file.
 - Click **Main Module (Program Module)** to create a module with a main routine.
 - Click **Module (System Module)** to create a module with attributes for read-only, view-only and not step-in.

According to the selection you make, the created RAPID module file opens in the RAPID editor.

For more information on managing file based RAPID modules, see [Managing file based RAPID modules on page 455](#).

Creating a controller configuration file

- 1 In the Backstage view, under **Files**, click **Controller Configuration File**.
- 2 You can select any of the following options.
 - **Empty I/O configuration file** to create a blank configuration file
 - **Example I/O configuration file** to create an I/O configuration file with some sample signals.
 - **Empty MMC configuration file** to create a blank MMC configuration file.
 - **Empty Motion configuration file** to create a blank motion configuration file.
 - **Empty SIO configuration file** to create a blank SIO configuration file.
 - **Empty SYS configuration file** to create a blank SYS configuration file.

7.3 Share

7.3.1 Pack and Go

Prerequisites

Any RobotWare 6 Add-in used by a virtual controller must be installed by the RobotStudio installer by downloading from the **RobotWare Add-ins** section of the **RobotApps** page in the **Add-Ins** tab, or by using the **Install Package** button of the **RobotApps** page. The RobotWare Add-Ins that RobotStudio uses are visible in the **Add-Ins** browser of the **Add-Ins** tab.



Note

RobotWare 5 Additional Options will not be visible in the **Add-Ins** browser. These options are always embedded in the **Pack&Go**.

Packing a station

- 1 In the Backstage view, under **Share data with other people**, click **Pack and Go**. The **Pack & Go** dialog opens.
- 2 Enter the name of the package and then browse and select the location of the package.
- 3 Select **Password protect the package**.
- 4 Type in your password in the **Password** box to protect your package.
- 5 Click **OK**.

The functions **GoOffline** and **Pack&Go** requires any RobotWare Add-Ins used by the systems to be installed on the PC.



Note

You can create a system in Installation Manager and add it to a RobotStudio station.

7.3.2 Unpack and Work

Unpacking a station

- 1 On the **File** menu, click **Unpack & Work** to open the **Unpack & Work Wizard**.
- 2 On the **Welcome to the Unpack & Work Wizard** page, click **Next**.
- 3 On the **Select package** page, click **Browse** and **Select the Pack & Go file to unpack** and **Select the directory where the files will be unpacked**. Click **Next**.
- 4 On the **Controller Systems** page, select the **RobotWare version** and click **Browse** to select the path to the **Media Pool**. Optionally, select the check box to automatically restore backup. Click **Next**.
- 5 On the **Ready to unpack** page, review the information and then click **Finish**.
- 6 On the **Unpack & Work finished** page, review the results and then click **Close**.

During an unpack operation, you are provided with two options, **Load files from local PC** and **Load files from Pack & Go**. Click the option to select the location from where the required files must be loaded. D



Note

If the Pack & Go file was set as password-protected during creation, then that password needs to be provided for the station to load.



Note

During an unpack operation, if you select the Copy configuration files to SYSPAR folder option, the configuration (CFG) files of the back up system inside the pack& go file gets copied to the SYSPAR folder of the new system. This is to avoid loss of configuration data during an I- start. Select this option for complex configurations like paint system.

7.3.3 Station Viewer

Overview

The Station Viewer can playback a station in 3D on computers that do not have RobotStudio installed. It packages the station file together with files needed to view the station in 3D. It can also play recorded simulations.

Prerequisites

- Visual C++ Redistributable for Visual Studio 2015.
- The .NET Framework 4.5 must be installed on the playback computer.



Note

RobotStudio 64-bit edition can create 64-bit Station Viewers. However, a 64-bit station viewer can run only on the Windows 64-bit operating system.

Creating and loading a Station Viewer

- 1 To create a Station Viewer, on the **File** menu, click **Share** and select **Save Station as Viewer**
- 2 Specify a file name and save as **.exe** file.
 - Select the option **Show comments on startup** and add text in the box to view the comment when the Station Viewer is started.
 - To save the simulation as Station Viewer, go to the **Simulation Control** group, click **Play**, and then select **Record to Viewer**. For more information, see [Running a simulation on page 363](#).



Note

Record to Viewer is enabled in Time Slice mode and it is disabled when Free Run mode is enabled, see, [Overview on page 353](#).

- 3 To load a Station Viewer, double-click the package (**.exe**) file on the target computer.

The results are displayed in the Output window and the embedded station file is automatically loaded and presented in a 3D view.

Configuring user settings of a Station Viewer

To configure the user settings of a Station Viewer, on the **File** menu, click **Options**.

Command Buttons

Apply	Click this button to save all options in the current page.
Reset	Click this button to reset to the settings you had before this session all values that you have changed on the current page.
Default	Click this button to reset to their default values all settings on the current page.

Continues on next page

7 File tab

7.3.3 Station Viewer

Continued

Options:General:Appearance

Select application language	Select the language to be used. The default language is the same as that of the target user's operating system if available, otherwise it is English.
Select color theme	Select the color to be used.

Options:General:Graphics

Background color	Select the color from the color theme, or from the color stored in the stations.
-------------------------	--

Simulation

When you run a simulation, the movements and visibility of objects are recorded. This recording is optionally included in the Station Viewer.

Simulation control buttons are enabled when the Station Viewer contains a recorded simulation.

Following are the Simulation control buttons:

Play	Starts or resumes simulation playback
Stop	Stops simulation playback
Reset	Resets all objects to their initial state and process time display to zero
Run mode	Select to run the simulation once or continuously
Process time	Displays the current simulation time

7.4 Options

Common buttons

Apply	Click this button to save all options in the current page.
Reset	Click this button to reset to the settings you had before this session all values that you have changed on the current page.
Default	Click this button to reset to their default values all settings on the current page.

Options:General:Appearance

Select application language	Select the language to be used. RobotStudio is available in the following seven languages: English, French, German, Spanish, Italian, Japanese, and Chinese (simplified).
Select color theme	Select the color to be used.
Default scale for zoomable windows	Defines the default scale to use for windows that are zoomable, for example, RAPID Editor, RAPID Data Editor and Configuration Editor.
Show ScreenTips	Select this check box to view ScreenTips.
Display Position Edit boxes with Red/Green/Blue background	Select the check box if you want to display the position boxes in the modify dialog boxes with colored background. Default value: selected.
Group related document windows under one tab	Select this check box to group related document window under one tab. Modifying this option requires a restart for the changes to take effect.
Restore hidden dialogs and messages	Select this check box to restore dialogs or messages which you may have hidden while using RobotStudio.

Options:General:Licensing

Disable licensing	Reverts to Basic mode to use features that do not require activation.
View installed licenses	Click to view the licenses listed by feature, version, type, expiration date and status.
Activation Wizard	Click to activate RobotStudio license.
RobotStudio user experience program <ul style="list-style-type: none"> • I want to help improve RobotStudio • I do not want to participate right now 	For RobotStudio Basic users, it is mandatory to participate in the user experience report. For RobotStudio Premium users, you can choose whether or not to participate in the user experience report .

Options:General:Units

Quantity	Select the quantity for which you want to change the units.
Unit	Select the unit for the quantity.
Display decimals	Enter the number of decimals that you want to be displayed.
Edit decimals	Enter the number of decimals that you want when modifying.

Continues on next page

7 File tab

7.4 Options

Continued

Default orientation format <ul style="list-style-type: none">• RPY angles (Euler ZYX)• Quaternions	Specifies the default format to use for orientations.
--	---

Options:General:Advanced

Number of undo/redo steps	The number of operations that can be undone or redone. Lowering this value can decrease memory usage.
Warn about running Virtual Controller processes on startup	Warns of orphaned VC processes.
Show acknowledge dialog box when deleting objects	Warns when deleting objects.
Show acknowledge dialog box when deleting targets and corresponding move instructions	Warns when deleting targets and move instructions.
Bring the output window to front if an error message is displayed	Select this check box to bring the output window to front if an error message is displayed

Options:General:Autosave

Enable autosave of RAPID	This check-box is selected by default. RAPID programs are saved automatically in every 30 seconds.
Enable autosave of station	Unsaved stations are saved automatically at the interval specified in the minute interval box.
Enable automatic backup of station files	Takes multiple backup of station files as specified in the Number of backups list and saves it in a sub-folder of the corresponding Stations folder (StationBackups). Requires a Solution.
Enable automatic backup of controllers in solution	Select this option to backup the virtual controllers of a solution when saving the station. The backups are stored in the Backups folder of the corresponding solution.

Options:General:Files & Folders

User Document Directory	Shows the default path to the project folder.
Solutions Directory	Shows the default path to the solutions folder.
...	To browse to the project folder, click the browse button.
Automatically create document subfolders	Select this check box to enable the creation of individual subfolders for document types.
minute interval	Specify the interval between the savings when using Autosave in this box.
Clear Recent Stations and Controllers	Clears the list of recently accessed stations and controllers.
Document Locations	Launches the Document Locations dialog box. For more information, see Document Locations window on page 70 .

Continues on next page

Additional distribution package location	RobotWare 6 and related RobotWare add-ins mediapools are distributed as distribution packages. For RobotStudio to find them, they need to be located in a specific folder. If the folder is not specified, the default location is used. On a Windows installation with English language, the default folder is C:\User\ <user name="">\AppData\Local\ABB Industrial IT\Robotics IT\DistributionPackages. The location can be customized by entering a search path here.</user>
Download packages to this location	Select this check box to download distribution packages to the user defined location instead of the default folder.
Mediapool	This is where RobotStudio searches for RobotWare 5.xx mediapools.

Options:General:Screenshot

Entire application window	Select this option to capture the entire application.
Active document window	Select this option to capture the active document window, typically the graphics window.
Copy to clipboard	Select this check box to save the captured image to the system clipboard.
Save to file	Select this check box to save the captured image to file.
Location	Specify the location of the image file. The default location is the "My Pictures" system folder.
...	Browse for the location.
File name	Specify the name of the image file. The default name is "RobotStudio" to which is added a date.
The file suffix list	Select the desired file format. The default format is JPG.

Options:General:Screen Recorder

Framerate	Specify the framerate in frames per second.
Start recording after	Select this option to start recording after the specified time.
Stop recording after	Select this option to stop recording after the specified time.
Include mouse cursor	Select this option to include the mouse cursor for the functions Record Application and Record Graphics .
Resolution - Same as window	Select this option to use the same resolution as in the graphics window.
Resolution - Limit resolution	Select this option to scale down the resolution as per the Maximum Width and Maximum Height you specify.
Maximum width	Specify the maximum width in pixels.
Maximum height	Specify the maximum height in pixels.
Video compression	Select the video compression format. Note that DivX format is not supported.
Location	Specifies the location of the videos.
File name and Output file format	Enter a file name and a file format. The default format is WMV. You can also save the output format as MP4. The recommended format is MP4.

Continues on next page

7 File tab

7.4 Options

Continued

Options:Robotics:Text Editor

Show line numbers	Select this check box to view line numbers in the RAPID editor
Show ruler	Select this check box to show the ruler in the RAPID editor
Show whitespace	Select this check box to show whitespace characters in the RAPID editor
Word wrap	Select this check box if you want to wrap long lines.
Convert tabs to spaces	Select this check box to convert tabs to spaces in the RAPID editor
Tab size	Specify the number of spaces for a Tab press.
RAPID Text styles	Specify the appearance of the various text classes.
Text color	Specifies the text color of the RAPID editor.
Background color	Specifies the background color of the RAPID editor.
Bold	Select this check box for bold-face fonts in the RAPID editor.
Italic	Select this check box for italicized fonts in the RAPID editor.

Options:Robotics:RAPID Profiler

Default RAPID log file	Specify the name of the default RAPID log file.
Always ask for filename	Select this check box to manually specify the file name of the log file always.
Open analysis when logging is stopped	Select this check box to open the analysis after the log is made.

Options:Robotics:Graphical Programming

Show dialog when warning for globally defined workobjects	Select this check box if you want RobotStudio to display a warning when there are workobjects with the same name that have been declared as in other tasks. Default value: selected.
Show synchronize dialog box after loading program /module	Select this check box if you want the synchronize dialog box to be displayed when you have loaded a program or a module. Default value: selected.
Show notification that default data is used	Select this check box if you want to be notified that <i>wobj0</i> and/or <i>tool0</i> is active and will be used in the current action. Default value: selected.
Set as active when creating tooldata	Select this check box if you want newly created tooldata to be set as active. Default value: selected.
Set as active when creating workobjects	Select this check box if you want newly created workobjects to be set as active. Default value: selected.
AutoPath	Specify the maximum gap allowed when creating an AutoPath.

Options:Robotics:Synchronization

Use default synchronization locations	Converting data, such as target to Workobject, shall use the default behavior for synchronization locations. Default value: selected.
Show default synchronization locations notification	Notifies of the behavior above. Default value: selected.
Declaration default locations	Specify the locations for corresponding objects when synchronizing to the VC.

Continues on next page

Options:Robotics:Mechanism

Approach Vector	Select the approach vector. Default value: Z.
Travel Vector	Select the travel vector. Default value: X.
When jumping to a target or move instruction with undefined configuration <ul style="list-style-type: none"> • Show dialog for setting the configuration • Use the configuration closest to the current one 	Select the required option to enable configuration to either allow the user to set the configuration or to select a configuration closest to the current one when it jumps to target or move instructions. Show dialog for setting the configuration is selected by default.

Options:Robotics:Virtual Controller

Always on top	Select this check box if you want to have the virtual FlexPendant always on top. Default value: selected.
Enable transparency	Select this check box if you want parts of the virtual FlexPendant to be transparent. Default value: selected.
Logging	After restarting the controller, <ul style="list-style-type: none"> • Select this check box to log the console output to "console.log" in the controller directory • Select this check box to log the console output to a console window
Automatically open virtual Operator Window	Select this check box to automatically open the virtual Operator Window. Default value: Enabled.

Options:Online:Authentication

Recent Users	Lists the recent users.
Remove/Remove All	Click these buttons to remove one or all recent users, respectively.
Enable Automatic Logoff	Select the check box if you want to log off automatically.
Timeout	Determines the length of the session before being automatically logged off.
Displays languages for controller texts such as event logs. <ul style="list-style-type: none"> • RobotStudio language • FlexPendant language 	Select the application that controls the language of the controller event logs.

Options:Online:Online Monitor

Update Rate (s)	Specifies the update interval.
Revolute Joint Limits	Sets the revolution limit for joints.
Linear Joint Limits	Sets the linear limit for joints.
Singularities	Sets the singularities.

Continues on next page

7 File tab

7.4 Options

Continued

Options:Online:Jobs

Max number of devices processed in parallel	Specifies the number of devices for which a job is executed in parallel.
--	--

Options:Graphics:Appearance

Anti-aliasing	Move the slider to control the multisampling level used to smooth jagged edges. The available options are hardware dependent. RobotStudio must be re-started for this setting to take effect.
Font	Specifies the font used in markups.
Advanced lighting	Select the check box to enable advanced lighting by default.
Perspective	Click this option to view the perspective view of the object by default.
Orthographic	Click this option to view the orthographic view of the object by default.
Custom background color	Click the colored rectangle to change default background color.
Show floor	Select the check box if you want the floor (at z=0) to be displayed by default. Change the floor color by clicking the colored rectangle. Default values: selected.
Transparent	Select the check box if you want the floor to be transparent by default. Default values: selected.
Show UCS Grid	Select the check box if you want the UCS grid to be displayed. Default value: selected.
Grid Space	Change the UCS grid space in the X and y coordinate directions by entering the requested value in the box. Default value: 1000 mm (or equivalent in other units).
Show UCS coordinate system	Select the check box if you want the UCS coordinate system to be displayed. Default value: selected.
Show world coordinate system	Select the check box if you want the coordinate systems to be displayed. Default value: selected.
Show navigation and selection buttons	Select this check box to have the navigation and selection buttons on the graphics window.

The settings you make take effect when creating a new station or when selecting **Default View Settings** from the **Settings** menu of the **View** tab of the **Graphics Tools** ribbon.

Options:Graphics:Performance

Rendering detail level	Select if the detail level is to be Auto, Fine, Medium or Coarse. Default value: Auto.
Render both sides of surfaces	Select the check box if you want to ignore the back-facing triangles. Default value: selected. Culling back-facing triangles improves the graphics performance but may give unexpected display if surfaces in models are not faced correctly.
Cull objects smaller than	Select the size in pixels under which objects will be disregarded. Default value: 2 pixels.

Continues on next page

The settings you make here are generic for all objects in RobotStudio. With the **Graphic Appearance** dialog box you can, however, override some of these settings for single objects.

Options:Graphics:Behavior

Navigation	Select a navigational activity and then specify the mouse buttons to be used for the selected navigational activity.
Navigation sensitivity	Select the navigation sensitivity when using the mouse movements or navigation buttons by clicking the bar and dragging it into position. Default value: 1.
Automatically adjust view center distance	Select to automatically adjust the view center distance when rotating or zooming a 3D view.
Selection radius (pixels)	Change the selection radius (that is, how close the mouse cursor click must be to an item to be selected) by entering the requested pixel value in the box. Default value: 5.
Selection highlight color	Click the colored rectangle to change the highlight color.
Selection preview	Select the check box to enable temporarily highlighting of items that may be selected when the mouse cursor passes over them. Default value: selected.
Show local coordinate system for selected objects	Select the check box to show the local coordinate system for the selected objects. Default value: selected.

Options:Graphics:Geometry

Detail Level	Specify the level of detail required when importing geometries. Select Fine , Medium or Coarse as required.
---------------------	--

Options:Graphics:Stereo/VR*

Mirror Output	Displays the image available in the VR glasses in the Graphics view.
Quality	Move the slider to adjust the quality of the image to an acceptable level of lag.
Disable Anti-Aliasing	This option is disabled by default for better performance.

Options:Simulation:Clock

Simulation speed	Sets the simulation speed relative to real time. You can define the simulation speed to a maximum of 200%
As fast as possible	Select this check box to run the simulation as fast as possible. When you select this option, the simulation speed slider is disabled.
Simulation timestep	Specifies the simulation timestep.
Run time slice in parallel for multiple controllers	When simulating a large number of controllers (such as ten controllers), this option may increase performance by utilizing multiple CPU cores. This option is hardware dependent and hence may give different results depending on the computer used.

Continues on next page

7 File tab

7.4 Options

Continued

Options:Simulation:Collision

Perform collision detection	Select if collision detection is to be performed during simulation or always. Default value: always.
Pause/stop simulation at collision	Select this check box if you want the simulation to stop at a collision or at a near miss. Default value: cleared.
Log collisions to Output window	Select this check box if you want the collisions to be logged to the output window. Default value: selected.
Log collisions to file:	Select this check box if you want to log the collisions to a file. Browse for the file to log in by clicking the browse button. Default value: cleared.
Enable fast collision detection	Select this check box to enhance the performance by detecting collisions between geometrical bounding boxes instead of geometrical triangles. This might result in falsely reported collisions, since the triangles are the true geometry and the bounding boxes always are larger. All true collisions will, however, be reported. The larger the object, the greater the number of false collisions that are likely to be detected.
View	Click this button to open the log file specified in the file box in Notepad.
Clear	Click this button to delete the log file specified in the file box.
...	Click this button to browse for the file in which you want to log the collisions.

Options:Simulation:Physics

Collision Geometry detail level	Set the slider to set the physics collision geometry either to faster or to a more accurate state.
--	--

8 Home tab

8.1 Overview

The Home tab

The Home tab contains the controls required for building stations, creating systems, programming paths and placing items.

8 Home tab

8.2 ABB Library

8.2 ABB Library

About this button

With this button, you can choose robots, positioners and tracks from their respective galleries.

8.3 Import Library

About this button

With this button, you can import equipment, geometries, positioners, robots, tools and training objects to your station libraries.

Importing a library

Use this procedure for importing library files to a station:

- 1 On the **Home** menu, click **Import Library** and select one of the following controls:
 - Equipment
 - User Library
 - Documents
 - Locations
 - Browse for Library



Note

You can also import component xml files (*.rsxml) to your station.

- 2 Click **Equipment** to import predefined ABB mechanism libraries.
- 3 Click **User Library** to select the user defined libraries.
- 4 Click **Documents** to open the Documents window. See [The Documents window on page 65](#)
- 5 Click **Locations** to open the Document Locations window. See [Document Locations window on page 70](#).
- 6 Click **Browse for Library** to select the saved library files.

8.4 Robot System

8.4.1 Robot System

About this button

With the **Robot System** button, you can either create a system from layout or template, choose an existing system, or select a system from a robot gallery and setup a conveyor tracking mechanism.

Creating a system from layout

- 1 Click **From Layout** to bring up the first page of the wizard.
- 2 In the **Name** box, enter the name of the system. The location of the system will be displayed in the **Location** box.
- 3 In the **RobotWare** list, select the version of RobotWare you want to use.
- 4 Click **Next**.
- 5 In the **Mechanisms** box, select the mechanisms that you want to include in the system.
- 6 Click **Next**.

The wizard now proposes a mapping of the mechanisms to a specific motion task, in accordance with the following rules:

- Only one TCP robot is allowed per task.
- Up to six motion tasks may be added, but only four TCP robots can be used, and they must be assigned to the first four tasks.
- The number of tasks may not exceed the number of mechanisms.
- If the system contains one TCP robot and one external axis, they will be assigned to the same task. It is, however, possible to add a new task and assign the external axis to it.
- If the system contains more than one TCP robot, any external axes will be assigned to a separate task. It is, however, possible to move them to other tasks.
- The number of external axes in a task is limited by the number of available drive modules in the cabinet (one for large robots, two for medium, three for small).

If only one mechanism was selected in the previous page, this page will not be shown.

Tasks can be added and removed using the respective buttons; mechanisms can be moved up or down using the respective arrows. To map the mechanisms to tasks, follow this step:

- 7 Optionally, make any edits in the mapping, and then click **Next**.
The System Option page appears.

Continues on next page

- 8 On the System Option page, you have the option to align Task Frame(s) with the corresponding Base Frame(s).
 - For single robot system, select the checkbox to align task frame with base frame:
 - For MultiMove Independent system, select the check box to align task frame with base frame for each robot.
 - For MultiMove Coordinated system, select the robot from the drop down list and select the check box to align task frame with base frame for the selected robot.
- 9 Verify the summary and then click **Finish**.

If the system contains more than one robot, the number of tasks and the baseframe positions of the mechanism should be verified in the System Configuration window.

**Note**

To create a system from layout, all your mechanisms such as robots, track motions and positioners, must be saved as libraries.

Adding a template system

- 1 Click **From Template** to bring up a dialog box.
- 2 In the **Select Template System** list, either select an appropriate template or click **Browse** and browse to one.
- 3 In the **Libraries** group, select whether to import libraries or to use the existing station libraries.
- 4 In the **System** group, enter a name and location, and then click **OK**.

Adding an existing system

- 1 Click **Existing** to bring up a dialog box.
- 2 In the **Select System Pool** list, select a folder.
- 3 In the **Systems Found** list, select a system.
- 4 In the **Libraries** group, select whether to import libraries or to use the existing station libraries.
- 5 Click **OK**.

Selecting a system from a robot gallery

- 1 Click **Quick System** to bring up a gallery, and then click the appropriate robot.

Adding objects to the conveyor

- 1 In the **Layout** browser, click the conveyor node.
- 2 Right-click **Workpiece source** folder and click **Add objects to workpiece source**.
- 3 In the **Set Pitch** tab, select the part from **Available Parts**.
- 4 Enter required Pitch value and set **Offset position** and **Offset orientation**.

Continues on next page

8 Home tab

8.4.1 Robot System

Continued

- 5 Click **Create**.

Modifying the connection between VC and conveyor

- 1 In the **Layout** browser, click the **Conveyor** node.
- 2 Click **Connections**.
- 3 Right-click **Connections** and select **Modify Connection**.
- 4 In the **Modify Connection** tab, enter new values.
- 5 Click **Apply**.

Removing objects from conveyor

- 1 In the **Layout** browser, click the **Conveyor** node.
- 2 Click the **Workpiece source node**.
- 3 Right-click the part that must be removed, and click **Remove**.

Clear conveyor

Use this option to detach workobjects, to clear the placed objects and to reset the conveyor to its start position. To access this option, In the **Layout** browser right-click the conveyor and click **Clear**.

8.4.2 External Axis Wizard

Overview

The ABB IRC5 controller is capable of controlling a vast number of mechanical units other than the ABB robot manipulator. Some external equipment such as workpiece positioners and robot tracks are standard ABB equipment for which ABB supplies and maintains controller system configuration files. But in many situations there is a need for customized external equipment.

It is possible to use standard ABB motor units and gear units in customized external equipment. The configuration file of the motor unit or gear unit in isolation is supplied and maintained by ABB. The External Axis Wizard tool simplifies the controller configuration for different combinations of motor units and gear units in customized mechanical units.

Mechanism modeling functionality in RobotStudio makes it possible to define custom kinematic mechanisms. The External Axis Wizard lets you specify mechanisms to include in the system. First, connect and configure each axis in a mechanism to a corresponding motor unit or gear unit. Then, the template configuration files are used to assemble a complete system configuration according to specification.



Note

The External Axis Wizard can be downloaded from the RobotApps website. To access the RobotApps website, visit www.abb.com/roboticssoftware.

Limitation

For IRC5P systems (used for painting), the External Axis Wizard supports only up to three external axes.

Prerequisites

- Build the station, and import or model the geometry of the mechanism. For information about creating a new station, see [Workflow of building a station on page 81](#).
- Use the Mechanism Modeling functionality to define custom kinematic mechanisms. For more information, see [Create Mechanism on page 339](#).
- Add a virtual controller to the station, and include additional drives corresponding to the axes of the mechanism to the controller system.
- The robot will not be attached to the mechanism. You must manually attach the robot to the external axis after successful configuration by the External Axis Wizard.

Using the External Axis Wizard

- 1 From the **Robot System** menu, click **External Axis Wizard**.

The first page of the wizard appears. It lists the the previously defined mechanisms (including robots) in the **Mechanisms** box.

Continues on next page

- 2 From the **Mechanisms** box, select the mechanisms to include in the system.
 - The **mechanism model** must be built in such a way that a kinematics model can be created. The joint chain must be defined such that it can be described by Denavit-Hartenberg parameters. The mechanism model must sometimes be modified to be able to keep the flange in the desired position. This can be done automatically by the External Axis Wizard, by adding a locked axis.
 - For adding an **additional locked axis**, when prompted, click **Ok**.
This is a dummy axis with frame definition. This dummy axis is added to the controller configuration and also to the RobotStudio mechanism. You cannot jog this additional axis.
- 3 Click **Next**.
The mechanisms along with their joints are listed.
- 4 Configure the **Mechanical Unit** based on the following information. The name of the mechanism in RobotStudio corresponds to the mechanical unit of the motion configuration.
 - Select the drive module (DM1 - DM4) to use for the mechanical unit.
If the mechanism has more than three joints, or, if there are several external mechanisms which are to be part of the configuration, then you need to use additional drive modules. In such cases, before using the External Axis Wizard, configure the controller system with the appropriate number of drive modules.
 - Optionally, you can use an **Activation Relay** by selecting the corresponding check box.
For more information, see *Technical reference manual - System parameters (3HAC050948-001)*.
 - For two axis positioners with rotating axes, where the two axes are in series, you can optionally select the **Error Model** check box.
Mechanisms defined with the error model can be calibrated with the FlexPendant using the standard four point method for each axis. This will compensate for deviations present in the real mechanisms.
 - You can configure two mechanical units to share a drive module.
To share the drive module with a mechanical unit, select that mechanical unit in the **Common Drive** list. The list shows all mechanisms (except TCP robot) with the same number of joints as the selected one. The joints of the mechanical units use the same logical axis and drive module. Note that the common drive option is not available unless an activation relay is chosen for the mechanical unit. This ensures that two mechanical units sharing a drive cannot be activated at the same time.
- 5 Configure the **joint** based on the following information.
 - For each joint select the **Motor Unit**. You can select a motor unit (MU), or a gear unit (MTD), or an interchange unit (MID). The list is populated with the standard motor and gear units provided by ABB.

Your choice will affect the capacity and cycle time of the external axis.

- **Electronically linked motors** are two motor units that drive the same axis. To link a motor unit to another one electronically, select the respective joint in the **Follow** list.
- The **Drive Unit** list is populated with the available drive units of the system. Each joint will be represented by its selected drive unit.
- You can configure **Logical Axis, Transmission, Link, Board and Node** according to your needs.

For more information, see *Technical reference manual - System parameters (3HAC050948-001)*.

**Note**

Default values are given for all attributes, except Motor Unit. However, you must review and change to the correct parameters to give a valid configuration.

6 Click Next.

The Finish page comes up.

7 To save the configuration to a file, click Save.

The configured kinematics of external axis devices are saved to a configuration file.

8 To load the saved configuration to the system on exiting from the wizard, select the Load Configuration to System check box.**9 Click Finish to exit the wizard.**

Use the saved configuration files to assemble a complete controller system configuration according to specification. When a system is configured, the MOC.cfg file with a subset for the external equipment is saved and a virtual controller is started for verification.

**Note**

All mechanisms which have been used in this configuration will be disconnected from the library. To maintain these changes in a library file (.rslib), you need to manually save it. This is because the External Axis Wizard may have automatically adjusted the mechanisms to enable them to be configured.

8.5 Import Geometry

Importing geometry

- 1 On the **Home** menu, click **Import Geometry** and select one of the following controls:
 - **User Geometry**
 - **Browse for Geometry**

- 2 Click **User Geometry** to select the user defined geometry.

- 3 Click **Browse for Geometry** to browse to the folder where the geometry is located.

For predefined geometries, click the **Geometry** icon to the left in the dialog box.

- 4 Select the required geometry and click **Open**.

If you want the geometry to move with another object, attach it to the requested object, see [Attach to on page 488](#).

To modify the detail level for import of geometries, see [Options on page 217](#).



Note

The **Modeling** tab also contains the **Import Geometry** option.

8.6 Export Geometry

Overview

The **Export Geometry** command is available for component groups, parts, stations and mechanism links. Right-click an open group, station, part or mechanism link and then select **Export Geometry** to access this command.

Exporting Geometry in a station

- 1 In the **Layout** browser, right-click an open station and select **Export Geometry**.
- 2 The **ExportGeometry:Station** pane opens, select the required format from the **Format** list.
- 3 Click **Export** and select the destination folder.

You can use these steps for a component group, part or mechanism link.

Supported formats

It is possible to export geometry in the following formats in a station.

Format	Description
dxg, svg (2D formats)	Selecting this format provides two export options, Export invisible objects and Only export objects intersecting the floor . You can configure the view and export all objects or only objects that touch the floor. When you select Only export objects intersecting the floor option, enter the value of Floor height (mm) . It is possible to export a RobotStudio function as a 2D floor layout when the View point is set to Top .
dae (3D format)	When you select this format, Export invisible objects check box is displayed, select this option to export all invisible objects in the station.

The supported export formats vary for component groups, parts and mechanism links. The following table lists various supported formats for exporting geometry for each of these elements:

Elements	Supported formats
Group	COLLADA(dae)
Mechanism links, Parts	ACIS(sat), IGES(igs, iges), STEP(stp, step, p21), VDAFS(vda, vdafs), Catia v4(model, exp), COLLADA(dae), OBJ(obj), RSGFX(rsgfx), VRML2, STL.

8 Home tab

8.7.1 Frame

8.7 Frame

8.7.1 Frame

Creating a frame

- 1 Click **Frame**.
- 2 In the dialog box, specify the positions for the frame.

Reference	Select the Reference coordinate system to which all positions or points will be related.
Frame Position	Click in one of these boxes, and then click the frame position in the graphics window to transfer the values to the Frame Position boxes.
Frame Orientation	Specify the coordinates for the frame orientation.
Set as UCS	Select this check box to set the created frame as the user coordinate system.



Note

The **Modeling** tab also contains the **Frame** option.

8.7.2 Frame from Three Points

Creating a frame from three points

- 1 Click **Frame from Three points** to bring up a dialog box.
- 2 Decide how you want to specify the frame:

To specify the frame using	Select
X, Y and Z coordinates, a point on the X axis and a point in the X-Y plane	Position
two points on the X axis and one point on the Y axis	Three Point

- 3 If you select **Position**:
 - Enter the **Position** for the object.
 - Enter the **Point on X axis** for the object.
 - Enter the **Point on X-Y plane** for the object.
 - Click **Create**.
- 4 If you select **Three Point**:
 - Enter the **First Point on X axis** for the object. This is the point closest to the frame's origin.
 - Enter the **Second Point on X axis** for the object. This is the point further away in the positive X direction.
 - Enter the **Point on Y axis** for the object.
 - Click **Create**.

The Create Frame From Three Points dialog box

Position	Select this option if you want to create the frame by using a position and two points.
Frame Position	Click in one of these boxes, and then click the frame position in the graphics window to transfer the values to the Frame Position boxes.
Point on X axis	Click in one of these boxes, and then click the point position in the graphics window to transfer the values to the Point on X axis boxes.
Point on X-Y plane	Click in one of these boxes, and then click the point position in the graphics window to transfer the values to the Point on X-Y plane boxes.
Three Point	Select this option if you want to create the frame by using three points.
First Point on X axis	Click in one of these boxes, and then click the point position in the graphics window to transfer the values to the First Point on X axis boxes.
Second Point on X axis	Click in one of these boxes, and then click the point position in the graphics window to transfer the values to the Second Point on X axis boxes.
Point on Y axis	Click in one of these boxes, and then click the point position in the graphics window to transfer the values to the Point on Y axis boxes.

Continues on next page

8 Home tab

8.7.2 Frame from Three Points

Continued

Set as UCS	Select this check box to set the created frame as the user coordinate system.
-------------------	---

8.8 Workobject

Creating a workobject

- 1 On the **Home** tab, in the **Path Programming** group, click **Other** and select **Create Workobject**.
The **Create Workobject** dialog box appears.
- 2 In the **Misc Data** group, enter the values for the new workobject.
- 3 In the **User Frame** group, do one of the following:
 - Set the position of the user frame by entering values for the **Position x,y,z** and the **Rotation rx, ry, rz** for the workobject by clicking in the **Values** box.
 - Select the user frame by using the **Frame by points** dialog box.
- 4 In the **Object Frame** group you can reposition the object frame relative to the user frame by doing any of the following:
 - Set the position of the object frame by selecting values for **Position x, y, z** by clicking in the **Values** box.
 - For the **Rotation rx, ry, rz**, select **RPY (Euler XYX)** or **Quaternion**, and enter the rotation values in the **Values** dialog box.
 - Select the object frame by using the **Frame by points** dialog box.
- 5 In the **Sync Properties** group, enter the values for the new workobject.
- 6 Click **Create**. The workobject will be created and displayed under the **Targets** node under the robot node in the **Paths&Targets** browser.

The Create Workobject dialog box

Name	Specify the name of the workobject.
Robot holds workobject	Select whether the workobject is to be held by the robot. If you select True , the robot will hold the workobject. The tool can then either be stationary or held by another robot.
Moved by mechanical unit	Select the mechanical unit that moves the workobject. This option is applicable only if Programmed is set to False .
Programmed	Select True if the workobject is to use a fixed coordinate system, and False if a movable (that is, external axes) will be used.
Position x, y, z	Click in one of these boxes, and then click the position in the graphics window to transfer the values to the Position boxes.
Rotation rx, ry, rz	Specify the rotation of the workobject in the UCS.
Frame by points	Specify the frame position of the user frame.
Position x, y, z	Click in one of these boxes, and then click the position in the graphics window to transfer the values to the Position boxes.
Rotation rx, ry, rz	Specify the rotation of the workobject.
Frame by points	Specify the frame position of the object frame.
Storage type	Select PERS or TASK PERS . Select the Storage Type TASK PERS if you intend to use the workobject in multimove mode.
Module	Select the module in which to declare the workobject.

8.9 Tooldata

Creating tooldata

- 1 In the **Layout** browser, make sure the robot in which to create the tooldata is set as the active task.
- 2 On the **Home** tab, in the **Path Programming** group, click **Other**, and then click **Tooldata**.
This opens the *Create Tooldata* dialog box.
- 3 In the **Misc Data** group:
 - Enter the **Name** of the tool.
 - Select whether the tool is to be held by the robot in the **Robot holds tool** list.
- 4 In the **Tool Frame** group:
 - Define the **Position x, y, z** of the tool.
 - Enter the **Rotation rx, ry, rz** of the tool.
- 5 In the **Load Data** group:
 - Enter the **Weight** of the tool.
 - Enter the **Center of gravity** of the tool.
 - Enter the **Inertia** of the tool.
- 6 In the **Sync Properties** group:
 - In the **Storage type** list, select **PERS** or **TASK PERS**. Select **TASK PERS** if you intend to use the tooldata in MultiMove mode.
 - In the **Module** list, select the module in which to declare the tooldata.
- 7 Click **Create**. The tooldata appears as a coordinate system in the graphics window.

8.10 Target

8.10.1 Teach Target

Teaching a target

To teach a target, follow these steps:

- 1 In the **Layout** browser, select the workobject and tool for which you want to teach the target.
- 2 Jog the robot to the preferred position. To jog a robot linearly, its VC must be running.
- 3 Click **Teach Target**.
- 4 A new target will be created in the browser, under the active workobject node. In the graphics window a coordinate system will be created at the TCP position. The configuration of the robot at the target will be saved.

8.10.2 Create Target

Creating a target

- 1 In the **Layout** browser, select the workobject in which you want to create the target.
- 2 Click **Create Target** to bring up a dialog box.
- 3 Select the **Reference** coordinate system you want to use to position the target:

If you want to position the target	Select
absolute in the world coordinate system of the station	World
relative to the position of the active workobject	Work Object
in a user-defined coordinate system	UCS

- 4 In the **Points** box, click **Add New** and then click the desired position in the graphics window to set the position of the target. You can also enter the values in the **Coordinates** boxes and click **Add**.
- 5 Enter the **Orientation** for the target. A preliminary cross will be shown in the graphics window at the selected position. Adjust the position, if necessary. To create the target, click **Create**.
- 6 If you want to change the workobject for which the target is to be created, expand the **Create Target** dialog box by clicking the **More** button. In the **WorkObject** list, select the workobject in which you want to create the target.
- 7 If you want to change the target name from the default name, expand the **Create Target** dialog box by clicking the **More** button and entering the new name in the **Target name** box.
- 8 Click **Create**. The target will appear in the browser and in the graphics window.



Note

The created target will not get any configuration for the robot axes. To add the configuration values to the target, use either **ModPos** or the **Configurations** dialog box.

If using external axes, the position of all activated external axes will be stored in the target.

The Create Target dialog box

Reference	Select the reference coordinate system to which all positions or points will be related.
Position	Click in one of these boxes, and then click the position in the graphics window to transfer the values to the Position boxes.
Orientation	Specify the orientation of the target.

Continues on next page

Add	Click this button to add a point and its coordinates to the Points list.
Modify	Click this button to modify an already defined point, after you have selected it in the Points list and entered new values.
Points	The target points. To add more points, click Add New , click the desired point in the graphics window, and then click Add .
More/Less	Click this button to expand or collapse parts of the create target dialog box.
Target name	Here you can change the name of the target you are creating. It is visible only when the create target dialog box is expanded.
Workobject	Here you can change the workobject in which the target is to be created. It is visible only when the create target dialog box is expanded.

8.10.3 Create Jointtarget

Creating a jointtarget

- 1 Click **Create Jointtarget** to bring up a dialog box.
- 2 If you want to change the default name of the jointtarget, enter the new name in the **Name** box.
- 3 In the **Axes Values** group, do as follows:
 - For the **Robot axes**, click the **Values** box and then click the down arrow. The **Joint Values** dialog box will be displayed. Enter the joint values in the boxes and click **Accept**.
 - For the **Joint axes**, click the **Values** box and then click the down arrow. The **Joint Values** dialog box will be displayed. Enter the joint values in the boxes and click **Accept**.
- 4 Click **Create**. The jointtarget will appear in the browser and in the graphics window.



Note

JointTargets for external axis are not visualized in the graphical window.

The Create Jointtarget dialog box

Name	Specify the name of the jointtarget.
Robot axes	Click the Values list, enter the values in the Joint values dialog box and click Accept .
External axes	Click the Values list, enter the values in the Joint values dialog box and click Accept .
Storage Type	Select the Storage Type TASK PERS if you intend to use the jointtarget in multimove mode.
Module	Select the module in which you want to declare the jointtarget.

8.10.4 Create Targets on Edge

Overview

Targets on Edge creates targets and move instructions along the edges of the geometric surface by selecting target points in the graphics window. Each point on a geometric edge has certain properties that can be used to position robot targets relative to the edge.

Creating targets on edge

- 1 On the **Home** tab, click **Target** and select **Create Targets on Edge**.
The **Targets on Edge** dialog box appears.



Note

The selection mode in graphics window is automatically set to **Surface**, and the snap mode is set to **Edge**.

- 2 Click on the surface of the body or part to create target points.
The closest point on the adjacent edge is calculated and added to the list box on as target points Point 1, Point 2



Note

When an edge is shared between two surfaces, the normal and tangent directions depend on the surface selected.

- 3 Use the following variables to specify how a target is related to a point on the edge.

Select...	to...
Vertical offset	specify the distance from the edge to the target in the surface normal direction.
Lateral offset	specify the distance from the edge to the target perpendicular to the edge tangent.
Approach angle	specify the angle between the (inverse) surface normal and the approach vector of the target.
Reverse travel direction	specify if the travel vector of the target is parallel or inversely parallel to the edge tangent.



Note

For each target point, a preview of the approach and travel vectors are displayed as arrows and as a sphere representing the point on the edge in the graphics window. The preview of the arrows are updated dynamically once the variables are modified.

- 4 Click **Remove** to remove the target points from the list box.

Continues on next page

8 Home tab

8.10.4 Create Targets on Edge

Continued

- 5 Click **More** to expand the **Create Targets on Edge** dialog box and to choose the following advanced options:

Use...	to..
Target name	change the target name from the default name to a new user defined name
Task	select the task for which to add targets. By default, active task in the station is selected.
Workobject	select the workobject for which you want to create the targets on edge
Insert Move Instructions in	create Move instructions in addition to targets, which will be added to the selected path procedure. The active process definition and process template will be used.

- 6 Click **Create**.

The target points and Move instructions (if any) are created and are displayed in the Output window and graphics window.

8.11 Empty Path

Creating an empty path

- 1 In the **Paths&Targets** browser, select the folder in which you want to create the path.
- 2 Click **Empty Path**.
- 3 To set the correct motion properties for the targets, select the active process in the **Change Active Process** box in the **Elements** toolbar.
- 4 If the active template is set to **MoveAbsJoint**, then:
 - A target that is dragged into a path will be converted into a **jointtarget** (recognized by a different icon on in the browser).
 - Joint targets and their instructions can only use *wobj0* and *tool0*.
 - One target can not be used as different types, for example, **MoveJoint**, but must be deleted and re-created.
 - When the target has been synchronized with the virtual controller, the joint target values will be calculated and inserted in the RAPID program.

It is possible to call a procedure from another procedure. In the **Paths & Targets** browser, click **Paths & Procedures** to view the folder structure. You can move procedures between folders using a drag-and-drop operation.

8.12 AutoPath

Overview

AutoPath helps in generating accurate paths (linear and circular) based on CAD geometry.

Prerequisites

You need to have a geometric object with edges, curves, or both.

Creating a path automatically

AutoPath feature can create paths from curves or along the edges of a surface. To create a path along a surface use selection level Surface, and to create a path along a curve, use selection level Curve. When using Selection level Surface, the closest edge of the selection will be picked for inclusion in the path. An edge can only be selected if connected to the last selected edge.

When using Selection level Curve, the selected edge will be added to the list. If the curve does not have any branches, all edges of the entire curve will be added to the list if holding the SHIFT button when selecting an edge. The Approach and Travel directions as defined in the RobotStudio options are used to define the orientation of the created targets, see [Options:Robotics:Mechanism on page 221](#).

Use this procedure to automatically generate a path.

- 1 In the **Home** tab, click **Path** and select **AutoPath**.

The AutoPath tool appears.

- 2 Select the edge or curve of the geometric object for which you want to create a path.

The selection is listed as edges in the tool window.



Note

- If in a geometric object, you select curve (instead of an edge), then all the points that result in the selected curve are added as edges to the list in the graphic window.
- Ensure you always select continuous edges.

- 3 Click **Remove** to delete the recently added edge from the graphic window.



Note

To change the order of the selected edges, select **Reverse** check box.

- 4 You can set the following **Approximation Parameters**:

Select or enter values in	to
MinDist	Set the minimum distance between the generated points. That is, points closer than the minimum distance are filtered.
Tolerance	Set the maximum deviation from the geometric description allowed for the generated points.

Continues on next page

Select or enter values in	to
MaxRadius	Determines how large a circle radius has to be before considering the circumference as a line. That is, a line can be considered as a circle with infinite radius.
Linear	Generate a linear move instruction for each target.
Circular	Generate circular move instructions where the selected edges describe circular segments.
Constant	Generate points with a Constant distance
End Offset	Set the specified offset away from the last target.
Start Offset	Sets the specified offset away from the first target.

The **Reference Surface** box shows the side of the object that is taken as normal for creating the path.

Click **More** to set the following parameters:

Select or enter values in	to
Approach	Generate a new target at a specified distance from the first target.
Depart	Generates a new target at a specified distance from the last target.

- 5 Click **Create** to automatically generate a new path.

A new path is created and move instructions are inserted for the generated targets as set in the Approximation parameters.



Note

The targets are created in the active workobject.

- 6 Click **Close**.

8 Home tab

8.13 MultiMove

8.13 MultiMove

Overview

For browsing between the pages of the MultiMove window, click the tabs in the navigation pane. By default the tabs are arranged in an order that corresponds to the typical workflow:

Setup tab

<i>System Config</i>	Select System	Here you select the system that contains the robots to program.
	System	Each robot in the system is presented in its own row in this grid. In the columns you make the settings as described below.
	Enable	Select this check box to use the robot in the MultiMove program.
	Type	Specify if the robot holds the tool or the work piece.
	Robot	Displays the name of the robot.
<i>Path Config</i>	Update	Click this button to update the paths in the grid if any of the paths have been changed. The button turns red if a change has been detected and an update is necessary.
	Paths	Each path in the station is presented in its own row in this grid. In the columns you make the settings as described below.
	Enable	Select this check box for the paths to use for the program.
	Order	Displays the order in which the paths will be executed. To change the order, use the lists in the path column for rearranging the rows in which the paths appear.
	Path	Sets the path to be executed here.
<i>Start Position</i>	Select Robot that other shall jump to	When creating a new start position, select a robot that the other will try to reach here.
	Apply	Jumps the other robots to the new start position.

Motion Behavior tab

This is used for specifying constraints and rules for how the robots shall move relative to each other. The default setting is no particular constraints, which results in the fewest joint movements. However, changing the motion behavior might be useful for:

- Locking the orientation or position of the tool.
- Optimizing cycle time or reachability by allowing tolerances.

Continues on next page

- Avoiding collisions or singularity by restricting joint motions.

Both Joint Influence and TCP Constraints restrict the robot's motions. Changes in these settings might result in lower performance or situations where it is impossible to find proper solutions. The weight values for Joint Weights and TCP Constraints set how much the setting for each joint or TCP direction shall affect the robots relative to each other. It is the difference between the weight values that matters, not the absolute values. If contradicting behaviors have been set, the one with the lowest weight value will win.

Tool Tolerance, instead of restricting, enables more motions. Therefore, tolerances may improve cycle and process times and enhance the reachability of the robots. Tolerances, too, have weight value; here is set how much the robots shall use the tolerance. A low value indicates that the tolerance will be used a lot, while a high value means that the robots will try to avoid using the tolerance.

The joint influence controls the balance of how much the robots will use their joints. Decreasing the weight value for one axis will restrict the motion for this axis, while increasing it will promote motion on this axis relative to alternative axes.

The TCP constraints control the position and orientation of the tool. Enabling a TCP constraint will decrease the motion of the tool and increase the motion of the work piece.

The tool tolerances control the allowed deviation between the tool and the work piece. By default, tolerances are not enabled, which means that no deviation is allowed. Enabling a tolerance, if applicable, might improve motion performance. For example, if the tool is symmetric around its Z axis, you can enable the Rz tolerance without affecting the accuracy of the generated paths.

The tool offset sets a fixed distance between the tool and the paths.

<i>Joint Influence</i>	Select Robot	Select the robot's joints to constrain in this box.
	Joints for Robot	Displays the robot's joints and their constraint weights. Each joint is presented in its own row.
	Axis	Displays which axis the constraint affects.
	Influence	Specify how much the motion for the axis is constrained. 0 means a locked axis, while 100 means no constraint relative to default constraint values.
<i>TCP Constraints</i>	Active TCP	This grid displays the position and rotations of the TCP together with their constraint weights.
	Enable	Select this check box to activate the constraint for this TCP pose.
	Pose	Displays the TCP pose that is affected by the constraint.
	Value	Specify the pose value to constrain at. Either type the value, or click the Pick from TCP button to use the values of the current TCP position.

Continues on next page

8 Home tab

8.13 MultiMove

Continued

	Influence	Specify how much the motion for the TCP value is constrained. 0 means a locked TCP at this pose, while 100 means no constraint relative to default constraint values.
<i>Tool Tolerance</i>	Enable	Select this check box to activate the tolerance for this tool pose.
	Pose	Displays the tool pose that is affected by the constraint.
	Value	Specify the pose value to apply the tolerance around.
	Influence	Specify the size of the tolerance. 0 means no deviation is allowed, while 100 means all deviations are allowed.
<i>Tool Offset</i>	Enable	Select this check box to activate the offset for this tool pose.
	Pose	Displays the tool pose that is affected by the offset setting.
	Offset	Specify the value of the offset here.

Create Paths tab

This tab is used for creating RobotStudio paths for the MultiMove robots. The created paths will accord with the motions displayed during the most recently played test simulation.

With the settings group you set up the MultiMove properties that connect the tasks for the tool robot and work piece robot to each other.

With the WP robot settings group you set up the properties for the task that will be generated for the work piece robot.

The generate path group contains the button that creates the paths.

<i>Settings</i>	Start ID	Specify the first ID number for the synchronization of the instructions for the robots.
	ID step index	Specify the gap between the succeeding ID numbers.
	Sync ident prefix	Specify a prefix for the syncident variable, which connects the sync instructions in the tasks for the tool robot and the work piece robot with each other.
	Task list prefix	Specify a prefix for the tasklist variable, which identifies the tasks for the tool robot and work piece robot to synchronize.
	Path Prefix	Specify a prefix for the generated paths.
	Target Prefix	Specify a prefix for the generated targets.
<i>WP robot settings</i>	WP Workobject	Specify the work object to which the targets generated for the work piece robot shall belong.

Continues on next page

	WP TCP	Specify which tool data the work piece robot shall use when reaching its targets.
<i>Generate Paths</i>	Create paths	Clicking this button generates paths in RobotStudio for the latest tested motions according to the settings specified.

MultiTeach tab

With this tab you teach complete synchronized move instructions for the robots in the MultiMove program.

<i>Settings</i>	Path Prefix	Specify a prefix for the paths to create.
	Target Prefix	Specify a prefix for the generated targets here.
	Start ID	Specify the first ID number for the synchronization of the instructions for the robots.
	ID step index	Specify the gap between the succeeding ID numbers.
	Sync ident prefix	Specify a prefix for the syncident variable, which connects the sync instructions in the tasks for the tool robot and the work piece robot with each other.
	Task list prefix	Specify a prefix for the tasklist variable, which identifies the tasks for the tool robot and work piece robot to synchronize.
	Select type of Sync instruction	Select the type of synchronization to use. Coordinated implies that all move instructions are synchronized for the robots. Semicoordinated implies that the robots work independently at some times and wait for each other at other (like when repositioning the work piece). For detailed information about the coordination types, see the <i>Application manual - Multimove</i> .
	Setup	Select the robots for teaching targets. This grid also displays the workobjects and tools that will be used for the targets.
<i>Teach</i>	MultiTeach Information	Displays a hierarchal tree which contains the created move instructions. The tree is organized the same way as the tree in the Layout browser.
	MultiTeach	Creates move instructions for the robots selected in the settings to their current positions. The created move instructions are immediately inserted at their correct places in the MultiTeach Information tree.

Continues on next page

8 Home tab

8.13 MultiMove

Continued

	Done	Confirms the creation of the instructions.
--	-------------	--

Test tab

RobotStudio's MultiMove window has a page with commands for testing multimove programs. Its default placement is at the bottom of the MultiMove window.

The status group displays the status of the simulation, that is, whether the current settings have been tested or if errors have occurred.

In addition to the status group, information from the virtual controller is also displayed in RobotStudio's Output window during simulation.

<i>Play</i>	<< < > >>	Jumps the robots, respectively, to the previous and next targets in paths. The double arrow buttons jump several targets at once, while the single arrow buttons jump one target for each click.
	Play	Click this button to move the robots along the paths. Play also has a list box in which you can activate the following commands: <ul style="list-style-type: none">• Save current position: Saves the current start position. Since the calculated motions are based on the robot start position saving the start position is useful when testing alternative solutions.• Restore saved position: Moves the robots back to the saved start positions.• Restore last closed loop position: Moves the robots back to the list used start position.• Close loop: Finds a suitable start position based on the robots' current positions and prepares the calculation of movements.• Calculate: Calculates and executes the movements.
	Simulation speed	Sets the speed at which the simulation is performed.
Settings	Stop at end	Select this check box to make the simulation stop after running the paths one time. If cleared, the simulation will continue playing over and over until it is stopped manually.
	Simulate Online	Select this check box to run the simulation as the movements are calculated. This is useful for troubleshooting purposes, since it displays and reports targets the robot cannot reach.

Continues on next page

	Cancel on error	Select this check box to stop the simulation if an error occurs. Cancel on errors is recommended to use when simulate online is used to minimize the number of error messages once the first error is identified.
	Watch Close Loop	Select this check box to display the search for a suitable start position in the graphics window. Clear the check box to jump the robots to the start position when it is found.

The MultiMove configure system wizard

The MultiMove configure system wizard guides you through configuring robots and workobjects for MultiMove system. If the workobjects are not configured correctly when the MultiMove functions are started, you will be asked whether to run the wizard. You can also start it manually from the Tools page of MultiMove.

The wizard contains four pages, the information pane at the bottom indicates the current page.

Workpiece robot	The workpiece robot page contains a list in which you select the robot that holds the workpiece. Only one robot can be set up as workpiece robot. If your station has several robots that hold the workpiece, set up one of them as workpiece robot and the other as tools robots, and create paths for these robots in which they only hold the workpiece.
Tool robots	The tool robots page contains a list in which you select the robots that operate on the work piece. All robots selected as tools robots will be coordinated to the workpiece robot. Any robot of the system that is selected neither as workpiece robot or tool robot will not be coordinated.
Workobjects	The Workobjects page contains a box for each tool robot in which you specify the workobject in which the targets for the MultiMove paths shall be created. The wizard will attach this workobject to the workpiece robot, for enabling MutliMove. Either type in a name for a new Workobject to create in the box, or select the Use existing WorkObject check box and then select one from the list.
Result	The Result page displays a summary of the station configuration. Either click Done to finish or Previous to go back and change the setup.



Note

The wizard will not help you configure the RobotWare system correctly. If the correct options are not used you will not be able to synchronize generated MultiMove paths to the virtual controller, even if you can use the MultiMove functions in RobotStudio.

Continues on next page

8 Home tab

8.13 MultiMove

Continued

The Analyze path tool

This tool checks whether existing paths are coordinated correctly for MultiMove. The analyzer opens in a window of its own and contains three pages. The information pane at the bottom indicates the current page.

<i>Select Paths</i>	Enable	Select to include the task in the analysis.
	Task	Displays the name of the task.
	Path	Select the path to analyze for the current task.
<i>Analyze</i>	Analyze	Click this button to start the analysis.
<i>Report</i>	 reportok	OK. The paths are compatible in the specified aspect.
	 reportin	Information. The paths are not fully compatible in the specified aspect, but the robot program may still be executable.
	 reporter	Error. The paths are not compatible in the specified aspect, and the robot program is not executable.

The Recalculate ID tool

This is one of the tools for working manually with MultiMove programs. It sets new sync ID arguments to the move instructions in a MultiMove path. By using the tool with the same start ID and ID step index on all paths that shall be synchronized, you can be sure that the IDs match if all paths contain the same number of move instructions.

Title	Displays the name of the path to recalculate IDs for.
Start ID	Sets the number of the first ID in the path.
ID Step index	Sets the size of the step to increase the ID number for each move instruction.
Only update instructions that has ID defined	Select this check box to recalculate only those IDs for instructions that have existing IDs. Clear this check box to also create IDs for instructions that have no IDs (for example, if you have added new move instructions that shall be coordinated).
The Only update instructions between SyncMove On/Off check box.	Select this check box to affect only those move instructions that belong to already synchronized parts of the path. Clear this check box to update IDs for instructions in all parts of the path.

Continues on next page

The Convert path to MultiMove path tool

This is one of the tools for working manually with MultiMove programs. It adds sync ID arguments to all move instructions in the path and, optionally, `SyncMoveOn/Off` instructions, thus preparing an ordinary path for MultiMove use.

You use the tool on one path a time, so for creating a MultiMove program, you convert one path for each robot and then create a tasklist and syncidents which you add to the Sync instructions.

Title	Displays the name of the path to recalculate IDs for.
Start ID	Sets the number of the first ID in the path.
ID Step index	Sets the size of the step to increase the ID number for each move instruction.
Add SyncMove On/Off before and after	Select this check box to add instructions that start and stop the synchronization.

The Create Tasklist tool

This is one of the tools for working manually with MultiMove programs. It creates a variable of the RAPID data type `tasks`, which identifies the tasks that will be synchronized. In each `SyncMoveOn` or `WaitSyncTask` instruction, you then specify which tasklist to use.

Tasklist name	Specifies the name of the tasklist.
Tasks that will be included	Select the check box for each task to include in the list.

The Create Syncident tool

This is one of the tools for working manually with MultiMove programs. It creates a variable of the RAPID data type `SyncIdent`, which identifies the sync instructions that shall be synchronized.

Syncident name	Specifies the name of the <code>SyncIdent</code> variable to create.
Tasks that Syncident will be created in	Select the check box for each task to use this Syncident in.

8.14 Teach Instruction

Teaching a move instruction

- 1 In the **Layout** browser, make sure the settings for active robot, workobject, tool, motion type and path are appropriate for the move instruction to create.
- 2 Jog the robot to the desired location. If jogging the robot using the freehand mode, you can also use snap modes for snapping its TCP to objects in the station.
- 3 Click **Teach Instruction**. A move instruction is now created last in the path.

8.15 Move Instruction

Creating a move instruction and a corresponding target

To create a move instruction, follow these steps:

- 1 Click **Move Instruction** to bring up a dialog box.
- 2 Select the **Reference coordinate system** for the move instruction.
- 3 Enter the **Position** to reach for the move instruction by clicking **Add New** in the **Coordinates** box and then click the required to-points in the graphics window. You can also enter the values in the **Coordinates boxes** and click **Add**.
- 4 Enter the **Orientation** for the move instruction.
- 5 By clicking the **More/Less** button, you can expand or collapse the **Create Move Instruction** dialog box. When the dialog box has been expanded, you can change the **Target name** and the **Work object** to which the target (with the move instruction) will belong.
- 6 Click **Create** to create the move instruction. The move instruction will appear under the path node as a reference to the target.



Note

To view the programmed speed of move instructions in a path, in the **Paths&Targets** browser, right-click the path and click **View > Show Speeds**. The speed values will be displayed along the path.

TrueMove path

Using the TrueMove path visualization, you can view the the programmed path of a robot accurately, regardless of the programmed speed. In RobotStudio, the TrueMove path will be visualized prior to executing the motion in the virtual controller. The path takes the zone data into account. The TrueMove path visualization applies to linear and circular motion instructions. Joint movements are visualized as straight lines even though the robot takes a different path. These movements are visualized with a dotted line to indicate that the robot will not follow the path accurately.

The Create Move Instruction dialog box for jointtarget movements

Name	Here you can change the name of the target you create when creating the move instruction.
Robot axes	Specify the joint values for the robot. Select the box and click the list to set the values.
External axes box	Specify the joint values for external axes, if any exist in the station. Select the box and click the list to set the values.
Storage Type	Click this button to expand or collapse parts of the create move instruction dialog box.
Module	Specify the module in which the jointtarget shall be declared.

8.16 Action Instruction

Creating an action instruction

- 1 In the **Paths&Targets** browser, select where to insert the action instruction.
To insert the action instruction at the beginning of a path then select the path.
To insert the action instruction after another instruction then select the proceeding instruction.
- 2 Right click **Path** and select **Insert Action Instruction**.
The **Create Action Instruction** dialog box appears.
- 3 From the **Instruction Templates** list, select the action instruction to create.
- 4 Optionally, modify instruction arguments in the **Instruction Arguments** grid.
For detailed information about the arguments for each instruction, see the [Action Instruction on page 260](#).
- 5 Click **Create**.

8.17 Instruction Template Manager

Overview

Use Instruction Template Manager to support instructions other than RobotStudio's default instructions set, for example, certain instructions like DispL and DispC are instructions used for glueing by a robot controller system with the RobotWare Dispense option. You can manually define the instruction templates for such instructions using the Instruction Template Manager. These instruction templates are exported to XML format and reused later.

RobotStudio provides pre-defined XML files that can be imported and used for robot controller systems with certain RobotWare options. For example, it is recommended to use RobotStudio ArcWelding PowerPac while using RobotWare Arc. The instruction template supports Robotware options like Continuous Application Protocol (CAP), Dispense (Disp), Fixed Position Events (Trigg), Spot Pneumatic, Spot Servo, Spot Servo Equalizing, Paint, Multimove Coordinated and Conveyor Tracking. When you start a new system, default instruction templates are loaded. When starting a system with one or more of these options, the corresponding instruction templates are added automatically.

Instruction Template Manager

You can use Instruction Template Manager to define instruction templates. In the Home tab, in Path Programming group, click the arrow next to Multimove to open the Instruction Template Manager pane. The Instruction Template Manager window consists of two panes. The names of Move and Action instructions appear in one pane and the arguments of the selected instruction in the other pane. You can select the required instruction and set the arguments to customize your instruction template.

The customized instruction template can be exported to **xml* format and can be imported and reused later. Use various buttons provided in the Instruction Template Manager window to add or delete Move and Action instructions. You can import or export the selected template or export all instruction templates here.

8 Home tab

8.18.1 Task

8.18 Settings

8.18.1 Task

Selecting a Task

Select a task from the **Task** drop-down list. The selected task indicates active task, to which new workobjects, tooldata, target, empty path or path from curve will be added.

8.18.2 Workobject

Selecting a Workobject

Select a workobject from the **Workobject** drop-down list. The selected workobject indicates active workobject, to which new targets and move instructions are added.

8 Home tab

8.18.3 Tool

8.18.3 Tool

Selecting a Tool

Select a tool from the **Tool** drop-down list. The selected tool indicates active tool, to which move instructions are added.

8.19 The Freehand Group

Move

- 1 In the **Layout** browser, select the item you want to move.
- 2 Click **Move**.
- 3 In the graphics window, click one of the axes and drag the item into position.

Continues on next page

8.19.1 Rotate

Rotating an item

- 1 In the **Layout** browser, select the item you want to rotate.
- 2 Click **Rotate**.
- 3 In the graphics window, click one of the rotational rings and drag the item into position.

If you press the **ALT** key while rotating, the item will snap 10 degrees at a time.

8.19.2 Jog Joint

Jogging the joints of a robot

- 1 In the **Layout** browser, select the robot you want to move.
- 2 Click **Jog Joint**.
- 3 Click the joint you want to move and drag it to the preferred position.

If you press the **ALT** key when jogging the joints of the robot, the robot will move 10 degrees at a time. If you press the **f** key, the robot will move 0.1 degree at a time.

8.19.3 Jog Linear

Jogging the TCP of a robot

- 1 In the **Layout** browser, select the robot you want to move.
- 2 In the **Freehand** group, click **Jog Linear**. A coordinate system will be displayed at the TCP of the robot.
- 3 Click the axis you want to move and drag the TCP to the preferred position.
If you press the **f** key while jogging the robot linearly, the robot will move with a smaller step size.

8.19.4 Jog Reorient

Reorienting the TCP rotation

- 1 In the **Layout** browser, select the robot you want to reorient.
- 2 In the **Freehand** group, click **Jog Reorient**.
An orientation ring appears around the TCP.
- 3 Click the orientation ring and drag the robot to rotate the TCP to the preferred position.
The X, Y, and Z orientation appears with units.



Note

If you press the **ALT** key while reorienting, the robot moves by 10 units and if you press the **F** key, it moves by 0.1 unit.



Note

The behavior of orientation differs with the different reference coordinate system (World, Local, UCS, Active Workobject, Active Tool).

8.19.5 MultiRobot Jog

Jogging robots in multirobot mode

- 1 In the **Freehand** group, click **MultiRobot Jog**. Select the robots to be jogged from the list of available robots.
- 2 Select the jogging mode, jog one of the robots and the other ones will follow the movement.

8.20 Graphics Tools

Overview

The **Graphics Tools** helps you to control the graphics view and to modify the appearance of objects. All available options are grouped under the following tabs.

- View Tab
- Edit Tab

Continues on next page

8 Home tab

8.20.1 View Tab

8.20.1 View Tab

Introduction

Use the View tab to choose view settings, control graphics view and create new views, and to show/hide the selected targets, frames, paths, parts, and mechanisms. The View tab options are grouped under the following groups.

- View
- Navigate
- Markups
- Lights
- Clip Planes
- Freehand
- Close

View Group

Introduction

The View group helps you to choose view settings, control graphics view and create new views, and to show/hide the selected targets, frames, paths, parts, and mechanisms. The following options are available:

- New View
- View Settings : Projection, Representation, Frame Size
- Settings
- Advanced Lighting
- Show/Hide
- Automatic Transparency
- Statistics
- Stereo Mode

Select **New View** to create a new view.

View Settings

You can select the following different view settings.

Setting	Description
Projection <ul style="list-style-type: none">• Orthographic• Perspective	To view the orthographic and perspective view of the object.
Representation <ul style="list-style-type: none">• Surface• Wireframe• Both• Hidden-line removal	To view the objects as a surface, wireframe, both surface and wireframe, by removing hidden lines.
Frame Size <ul style="list-style-type: none">• Large• Medium• Small	To view the frame in large, medium and small sizes.

Continues on next page

Advanced Lighting

Advanced Lighting activates the advanced lighting model that enables features such as multiple lights, shadows and environment mapping. This feature requires graphics hardware that supports Direct3D feature level 10_1 or higher.

The standard lighting model is supported on all systems and is optimized for performance and visibility.

Settings

The **Settings** button in the **View** tab provides various display options for graphics. The **Settings** commands work on the active graphics view and do not affect persisted settings or other views. The available options are:

Settings	Description
Show Floor	Shows or hides the floor the graphics view.
Show UCS Grid	Shows or hides the UCS grid in the graphics view.
Show World Coordinates	Shows or hides the world coordinates in the graphics view.
Show Buttons	Shows or hides buttons in the graphics view.
Reset Floor Size	Adjusts the floor and UCS grid to cover the area used by objects in the station.
Background Color	Allows the user to set a custom background for the view.
Default View Settings	Opens the Options dialog box that shows the defaults settings.
Reset to Defaults	Resets the active view to the default settings.

Show/Hide

You can either show or hide the following options:

- Target Names
- Frame Names
- Path Names
- All Targets/Frames
- All Paths
- All Parts
- All Mechanisms

Automatic transparency

Automatic Transparency makes objects transparent when they cover a large part of the graphics view. Click this button to enable **Automatic Transparency**. If you enable **Automatic Transparency**, in 3D view when you zoom in on objects, the closest part becomes gradually invisible and you would be able to see objects beyond the closest object.

3D View

The 3D view shows the graphical overview of the robot, tool and its work envelope. All robot activity is shown-in real time, which provides the opportunity to observe the actual robot in operation. The user can move the 3D view around the robot for more details.

Continues on next page

8 Home tab

8.20.1 View Tab

Continued

Virtual Reality

The **Virtual Reality** button gets enabled when you connect VR glasses (Oculus Rift or HTC Vive) to the PC. RobotStudio and its Station Viewer works with HTC Vive and Oculus rift. These devices have motion tracking sensors for location and orientation tracking of the headset and the hand controls. The hand controls can be used to interact with the virtual reality environment. The use of HTC Vive requires a high-performance gaming PC. Check the supplier web page for installation details, <http://www.vive.com/> and for details on Oculus rift, visit <https://www.oculus.com>.

Navigate Group

Introduction

Navigate group contains buttons for creating and managing viewpoint and for controlling the orientation of graphics.

Setting	Description
View Orientation	To view the objects in the following different orientations. <ul style="list-style-type: none">• View All• View Center• Top• Bottom• Front• Back• Left• Right
Create Viewpoint	Stores the location and direction of a virtual camera in the 3D environment.

Viewpoint

A **Viewpoint** stores the location and direction of a virtual camera in the 3D environment. It stores points of interest in a station to create camera movements during simulation.

Creating Viewpoint

You can create a viewpoint in a station in two ways:

- 1 In the **View** tab, click **Create Viewpoint**.
- 2 In the **Layout** browser, right-click the station and select **Create Viewpoint**.

A viewpoint is created and displayed (as an eye icon) in the layout browser to the left.

The position and direction of the **Viewpoint** can also be visualized as an arrow in the 3D graphics. By default, the newly created viewpoints are not visible and cannot be selected by clicking on the graphics.

Viewpoint functions

In the **Layout** browser, right-click **Viewpoint** to perform the following functions:

Function	Description
Move to Viewpoint	Moves the active 3D view to the location stored in the viewpoint.

Continues on next page

Function	Description
Set to current	Modifies the viewpoint to the current location and direction of the active 3D view. This action cannot be undone.
Visible	Toggles the visibility of the viewpoint 3D representation. This action cannot be undone.
Delete	Deletes the viewpoint. This action cannot be undone.
Rename	Renames the viewpoint. This action cannot be undone.

Move to Viewpoint

You can also move active 3D view to the location stored in the Viewpoint using Event manager.

- 1 Create a viewpoint.
- 2 Add an event.
The Create new event dialog box appears.
- 3 Select **Simulation** under **Activation** and **Simulation time** under **Event trig type**. Click **Next**.
- 4 Set the activation time. Click **Next**.
- 5 Select **Move to Viewpoint** from **Set Action type**. Click **Next**.
- 6 Select the viewpoint from **select Viewpoint** and set the transition time.
- 7 Click **Finish**.

Move to viewpoint function is also executed when replaying the simulation in a Station Viewer. In addition, you can switch between view points using the MoveToViewpoint Smart Components, see [Running a simulation on page 363](#).

Markups Group

Overview

A markup is a text box displayed in the 3D graphics. It is similar to the temporary text shown when performing measurement or freehand movement, but it is part of the station.

The markup is displayed as a node in the layout browser and remains so when the station is saved. It appears as text bubble pointing to a position in the graphics window.

Creating Markup

Use this procedure to create markup to an object

- 1 In the **Home** tab, click **View** and select **Create Markup**.

The **Create Markup** dialog box appears.



Note

Alternatively, in the **Layout** browser, right-click the station and select **Create Markup** for the dialog box to appear.

Continues on next page

8 Home tab

8.20.1 View Tab

Continued

- 2 In the **Markup Text** field, enter a name for the markup text.
- 3 In the **Pointer position** field, set the position of the pointer.
- 4 Select **Always on top** if you want to display the text on top.
- 5 Click **Create**.

Markup functions

In the Layout browser, right-click **Markup** to perform the following functions:

Function	Description
Visible	Shows or hides the markup in the 3D graphics.
Modify Markup	Modifies the Markup properties.
Attach to	Attaches the markup to another graphical object.
Detach	Detaches the attached markup.
Delete	Deletes the markup.
Rename	Changes the name of the markup object.

Modify Markup

Use this procedure to modify the markup properties:

- 1 In the **Layout** browser, right-click the markup and select **Modify Markup**.
The **Modify Markup** dialog box appears.
- 2 Modify the markup text, pointer position or text position.
- 3 Click **Apply** for the changes to take effect.
- 4 Click **Close**.

Lights Group

Overview

The Lights group helps you to control the number and nature of light sources in the station when advanced lighting is enabled. There are four different kinds of light sources:

- **Ambient Light** – Controls the ambient (background) light level in the station.
- **Infinite Light** – A directional light source, similar to the sun, this light source can cast shadows.
- **Spotlight** – A light source with a cone of influence, this light source can cast shadows.
- **Point light** – Casts light radially from a specified position, this light source can not cast shadows.

By default, a new station contains two infinite light sources in addition to the ambient light source. The ambient light source cannot be removed or created, but it can be disabled. The **Create Light** menu contains commands for creating a new light source and adding it to the station.

Continues on next page

Light Properties

In the browser, right-click the light source and then select **Light Properties** from the context menu. You can view the **Light Properties** window. Use this window to modify the light source. The **Light Properties** window contains different controls depending on the type of light.

Settings	Description
Enabled (all kinds)	Enables or disables the light source
Casts shadows (infinite and spot lights)	Causes objects influenced by the light to cast shadows
Color (all kinds)	Controls the color of the light
Ambient intensity (ambient light)	Controls the ambient (background) intensity of the light
Diffuse intensity (infinite, spot and point lights)	Controls the intensity of diffuse highlights
Highlight (infinite, spot and point lights)	Controls the intensity of specular highlight
Position (spot and point lights)	Controls the position of the light source
Direction (infinite and spot lights)	Controls the direction of the light
Limit range (spot and point lights)	Optionally limits the range of influence of the light
Spotlight angle (spot lights)	Controls the angle of the light cone

Light presets

Light sources are saved in the station. User can use light presets to save a set of lights for reuse. The **Presets** menu contains a list of user defined light presets. When a preset is selected, the light sources in the station are replaced by the preset. The menu also contains the following commands:

Command	Description
Reset lights to default	Resets light to the default preset
Save lights as preset	Saves the lights in the station as a preset
Edit presets	Allows the user to remove previously created presets

Clip Planes

Overview

A clip plane is an infinite plane that cuts through geometric objects in the station. Objects on one side of the plane are visible while objects on the other side are invisible. A station can contain multiple clip planes, but each graphics view can only have one active clip plane.



Note

Non-geometric objects such as graphic representations of paths and targets are not affected.

Continues on next page

8 Home tab

8.20.1 View Tab

Continued

Creating and Editing a Clip Plane

Use the following procedure to create and edit a clip plane.

- 1 In the **View** tab, click **Create Clip Plane**.
- 2 In the browser, right-click the clip plane. The context menu appears.
- 3 In the context menu, click **Edit**. The **Clip Plane** property window appears.

When a clip plane is selected in the browser, a graphical representation of the plane is displayed in the **Graphics** view. This allows the user to move and rotate the clip plane by using freehand controls.

Clip Plane Functions

Function	Description
Position	Controls the position of the clip plane, you can select or type in the x, y and z co-ordinates of the clip plane.
Normal	Controls the orientation of the clip plane, you can select or type in the x, y and z co-ordinates of the clip plane.
Flip	Allows the user to reverse the orientation of the clip plane.
Active	Enables or disables the clip plane in the active graphics view.

Freehand

Freehand options are used to move and rotate the selected object. User can select the coordinate system.

Moving an item

- 1 In the **Layout** browser, select the item you want to move.
- 2 Click **Move**.
- 3 In the graphics window, click one of the axes and drag the item into position.

Rotating an item

- 1 In the **Layout** browser, select the item you want to rotate.
- 2 Click **Rotate**.
- 3 In the graphics window, click one of the rotational rings and drag the item into position.
If you press the **ALT** key while rotating, the item will snap 10 degrees at a time.

World

Use this option to move or rotate an object in the station in relation with the specified coordinate system. The following options are available:

- World
- Local
- UCS
- Active Workobject
- Active Tool

Close Graphics

Select this option to close the **Graphics Tools** tabs.

8.20.2 Edit Tab

Overview

The **Edit** tab contains commands for working with materials and their application on geometric objects. The available options are:

- Materials
- Pick Material
- Apply Material
- Replace Material
- Edit Materials
- Adjust Textures
- Invert Surfaces
- Close Graphics

Appearance Group

The **Appearance** group contains the following options:

Settings	Description
Materials	Contains a gallery of predefined and user defined materials
Pick Material	Allows the user to select a material
Apply Material	Activates or deactivates apply material mode
Replace Material	Allows the user to replace material in a part that contains several different materials.
Edit Materials	Allows editing of user defined materials
Adjust Textures	Allows the user to adjust texture coordinates on surfaces directly in the main graphics view
Invert Surfaces	Allows the user to invert the surfaces when selected in the Graphics window. The back side of the surface is highlighted in red.
Close Graphics	To close the Graphics tools tab.

Materials

The **Material** menu contains controls for setting material parameters or for selecting a material from the list of user defined and predefined materials. It is also possible to save the current material to the user defined materials list.

Apply Material

When **Apply Material** is activated, the active material is automatically applied to the geometric surfaces or objects (depending on selection mode) selected in the Graphics view. The active material is selected by using the Materials menu or the Pick Material command. When a material is selected, Apply Material is automatically activated.

Replace Material

The **Replace Material** menu allows you to replace material in a part that consists of different materials. Select a material from the Materials gallery and click on the surface of the part to replace its material.

Continues on next page

8 Home tab

8.20.2 Edit Tab

Continued

Edit Materials

The **Edit Materials** menu allows editing of user defined materials. Click this button to see the list of defined materials. This list can be edited by adding, deleting and copying materials. The name and description of a material can be changed by right-clicking in the list. A preview of the selected material is displayed in the Graphics view.

Adjust Textures

The **Adjust Textures** menu allows the user to adjust texture coordinates on surfaces directly in the main Graphics view. When the command is activated and a textured surface is selected, the user can use the keyboard to move, rotate, mirror and scale the texture on the surface.

Graphics browser

A separate browser window is displayed when one of the graphics menu is selected. It contains objects in the station that are related to the graphics system. The following options are available:

- Markups
- Viewpoints
- Lights
- Clip planes

Close Graphics

Select this option to close the **Graphics Tools** tabs .

9 Modeling tab

9.1 Overview

The Modeling tab

The Modeling tab contains the controls for creating and grouping components, creating bodies, measurements and CAD operations.

9 Modeling tab

9.2 Component Group

9.2 Component Group

Creating a component group

- 1 Click **Component Group**. The **Group** node will be displayed in the **Layout** browser.
- 2 Click the objects to add to the group. Drag them to the **Group** node.

9.3 Empty Part

Creating an empty part

- 1 Click **Empty Part**. The **Part** node will be displayed in the **Layout** browser.

9 Modeling tab

9.4.1 Smart Component

9.4 Smart Component

9.4.1 Smart Component

Overview

Smart Component is a RobotStudio object (with or without a 3D graphical representation) that has the behavior which can be implemented by code-behind and/or aggregation of other Smart Components.

Terminology

The following table describes the different terminologies that you come across when working with Smart Component.

Term	Definition
Code behind	A .NET class associated with a Smart Component that can implement custom behavior by reacting to certain events, for example simulation time steps and changes in property values.
[Dynamic] property	An object attached to a Smart Component that has value, type and certain other characteristics. The property value is used by code behind to control the behavior of the Smart Component.
[Property] binding	Connects the value of one property to the value of another property.
[Property] attributes	Key-value pairs that contain additional information about a dynamic property, for example value constraints.
[I/O] signal	An object attached to a Smart Component that has a value and a direction (input/output), analogous to I/O signals on a robot controller. The signal value is used by code behind to control the behavior of the Smart Component.
[I/O] connection	Connects the value of one signal to the value of a different signal.
Aggregation	The process of connecting several Smart Components using bindings and/or connections in order to implement a more complex behavior.
Asset	Data object contained in a Smart Component. Uses include code behind assembly and localized resources.

9.4.2 Smart Component Editor

Overview

The Smart Component Editor allows you to create, edit, and aggregate Smart Components using a graphical user interface. It is an alternative to using the xml based library compiler.

Layout of a Smart Component Editor

It consists of an icon, the name, the description for the component wherein the description can be modified by typing in the text box, and a combo box.

The combo box specifies the language for editing localized strings (captions and descriptions) in the component. The default language is always English, even if the application language is different. For more information, see [Assets on page 287](#).

The Smart Component Editor consists of the following tabs:

- [The Compose tab on page 286](#)
- [The Properties and Bindings tab on page 289](#)
- [The Signals and Connections tab on page 292](#)
- [The Design tab on page 295](#)

Opening a Smart Component Editor

Click **Smart Component** or select **Edit Component** from the context menu.

The **Smart Component Editor** window appears.

Protecting a Smart Component from edits

You can protect a Smart Component from being edited. To protect the smart component, right-click the smart component, and then click **Protected**. You can also optionally specify a password that will be required to unlock the component for edits.

Protecting a Smart Component hides its internal structure and protects it from edits. You can use this feature to hide the complexity in the smart component, and to secure the functionality. Child components in a protected smart component are hidden in all RobotStudio browsers and also in the Signal Analyzer browser.



Note

Protecting a Smart Component in this manner is a way of hiding complexity, and is not for providing security or securely protecting it.

9 Modeling tab

9.4.3 The Compose tab

9.4.3 The Compose tab

Overview

The Compose tab consists of the following:

- [Child components on page 286](#)
- [Saved States on page 287](#)
- [Assets on page 287](#)

Child components

It is a list box that displays all the objects contained by the component. Objects connected to a library have an overlay that indicates that the objects are locked. Smart Components are displayed first followed by other type of objects.

If an object is selected from the list, the following commands are displayed in the right panel:

Command	Description
Add component	Adds a child object to the component from the list. You can select a built-in base Smart Component, a new empty Smart Component, a library from file or a geometric part from file. Base components are organized as sub-menus based on the usage. For example, <i>Signals and Properties</i> , <i>Sensors</i> , <i>Actions</i> and so on. Recently used base components are listed at the top. For more information about base Smart Component, see Basic Smart Components on page 296 .
Edit parent	Sets the context of the Editor to the parent of the component that is currently being edited. If the parent is the station, see Station Logic on page 361 .
Disconnect from library	Disconnects the selected object from library, allowing it to be edited.
Export to XML	Opens a dialog box where you can export and save the component definition along with its properties as an <i>*.rsxml</i> file

Right-click on the selected object to display the following context menu items

Item	Description
Edit	Sets the context of the Editor to the selected child object.
Delete	Deletes the child object.
Show in Browser	Indicates if the object should be displayed in the Layout browser.
Set as Role	Sets the object as the Role of the component. The Smart Component will inherit certain characteristics of the Role object. For example, attaching a component with a tool as Role to a robot will cause a ToolData to be created.
Properties	Opens the Property editor dialog box for the object. See Property Editor on page 313 .

Continues on next page

Saved States

The state of the component can be saved to be restored later. The state contains selected modifiable aspects of the component and its child components at the time when the state was saved. The following commands are available:

Command	Description
Save Current State	Opens the Save Current State dialog box. See Save Current State on page 287 .
Restore Selected State	Restores the component to the selected state.
Details	Opens a window that displays detailed information about the selected state.
Delete	Deletes the selected state.

Save Current State

- 1 In the **Name** text box, enter a name for the state. If a state with the same name already exists, you will be asked to overwrite the existing state.
- 2 In the **Description** text box, enter the description for the state.
- 3 In the **Values to save**, select the value to be saved.
- 4 Select the check box to save the state of all child components.

**Note**

When working on a station level,

- In the **Values to save**, you can also select certain Virtual Controller values in the saved states.
- You need not select the option **Recursive** as the state of the station is always saved.

For more information, see [Station Logic on page 361](#).

Assets

The assets contained in the component are displayed as grid.

The following commands are available:

Command	Description
Add Asset	Opens a dialog box and allows you to browse and select any file as an asset.
Set Icon	Opens a dialog box and allows you to browse and select an image that represents a Smart Component.
Update All Assets	Replaces the data of all the assets with the data of the corresponding file on the disk. If the file is not available, a warning message is displayed in the output window.
View	Opens the selected asset in the associated program
Save	Opens a dialog box and allows you to save the selected asset.
Delete	Deletes the selected asset.

Continues on next page

9 Modeling tab

9.4.3 The Compose tab

Continued



Note

The text resources (descriptions) for properties and signals are stored in an asset called *Resources.<language-id>.xml*. If this is deleted, the texts for that language will be empty and the default (English) will be used. The default language when authoring a component is always English, regardless of the application language.

9.4.4 The Properties and Bindings tab

Overview

The Properties and Bindings tab consists of the following:

- [Dynamic Properties on page 289](#)
- [Property Bindings on page 290](#)

Dynamic Properties

The dynamic properties contained in the component are displayed in a grid.

The following commands are available

Command	Description
Add Dynamic Property	Opens the Add Dynamic Property dialog box. See Add or Edit Dynamic Property on page 289 .
Expose Child Property	Opens the Expose Child Property dialog box. See Expose Child Property on page 290 .
Edit	Opens the Edit Dynamic Property dialog box for the selected property.
Delete	Deletes the selected property.

Add or Edit Dynamic Property

The Add Dynamic Property dialog box allows you to create a new dynamic property or edit an existing property.

The following controls are available:

Control	Description
Property Identifier	Specifies an identifier for the property. The identifier must be alphanumeric, start with a letter and must be unique.
Description	Detailed description of the property.
Read-only	Indicates if the property value should be possible to modify in GUI such as the Property Editor.
Property Type	Specifies the type of the property from a list of allowed types.
Property Value	Specifies the value of the property. The control is updated when you change the property type and/or attributes.
Attributes	Allows you to add, remove, and modify property attributes. The following lists the available attributes: <ul style="list-style-type: none"> • MinValue • MaxValue • Quantity • Slider • AutoApply Numeric attributes are specified in SI units.



Note

When editing an existing property, the Identifier and Type controls are locked and cannot be modified. If the input is valid the OK button is enabled, allowing you to add or update the property. If not, an error icon is displayed.

Continues on next page

9 Modeling tab

9.4.4 The Properties and Bindings tab

Continued

Expose Child Property

The **Expose Child Property** dialog box allows you to add a new property and bind to an existing property in a child object. The new property will have the same type and attributes as the child property.

The following controls are available:

Control	Description
Property Identifier	Identifier of the new property. By default, this is the same as the identifier of the selected child property.
Binding Direction	Specifies the direction of the property binding
Source or Target Object	Specifies the child object for which to expose a property.
Source or Target Property	Specifies the child property.

Property Bindings

The property bindings contained in the component are displayed in a grid.

The following commands are available:

Command	Description
Add Binding	Opens the Add Binding dialog box.
Add Expression Binding	Opens the Add Expression Binding dialog box.
Edit	Opens the Edit Binding or Edit Expression Binding dialog box, depending on the type of binding selected.
Delete	Deletes the selected binding.

Add or Edit Binding

The **Add Binding** dialog box allows you to create or edit a property binding.

The following options are available:

Control	Description
Source Object	Specifies the owner of the source property.
Source Property	Specifies the source of the binding.
Target Object	Specifies the owner of the target property.
Target Property	Specifies the target of the binding. Only properties of the same type as the source property type are listed.
Allow cyclic binding	Allows the target property to be set two times in the same context, which otherwise generates an error. The target list box, besides dynamic properties also displays some common properties such as object transform that can only be used as target and not as source.

Continues on next page

Add or Edit Expression Binding

The **Add Expression Binding** dialog box allows you to specify a mathematical expression as the source of a property binding.

The following controls are available:

Control	Description
Expression	<p>Specifies the mathematical expressions.</p> <p>The following lists the allowable mathematical expressions:</p> <ul style="list-style-type: none"> • Allowed operators: +, - (unary and binary) *, /, ^ (power), Sin(), Cos(), Sqrt(), Atan() and Abs(). • Allowed operands: Numeric constants, PI, and Numeric dynamic properties on the current smart component and any child smart components. <p>The text box has the IntelliSense-like functionality which allows you to select from the available properties. If the expression entered in the text box is invalid, an error icon is displayed.</p>
Target Object	Specifies the owner of the target property.
Target Property	<p>Specifies the target of the binding.</p> <p>Only numeric properties are listed.</p>

9 Modeling tab

9.4.5 The Signals and Connections tab

9.4.5 The Signals and Connections tab

Overview

The Signals and Connections tab consists of the following:

- [I/O Signals on page 292](#)
- [I/O Connections on page 293](#)

I/O Signals

The I/O Signals contained in the component are displayed in a grid.

The following commands are available:

Command	Description
Add I/O Signals	Opens the Add I/O Signals dialog box.
Expose Child Signal	Opens the Expose Child Signal dialog box.
Edit	Opens the Edit Signal dialog box.
Delete	Deletes the selected signal.

Add or Edit I/O signals

The Add I/O Signals dialog box allows you to edit an I/O signal, or add one or more I/O signals to the component.

The following controls are available:

Control	Description
Type of Signal	Specifies the type and direction of the signal. The following are the available types of signals: <ul style="list-style-type: none">• Digital• Analog• Group
Signal Base Name	Specifies the name of the signal. The name must contain an alphanumeric character and start with a letter (a-z or A-Z). If more than one signal is created, numeric suffixes specified by Start Index and Step are added to the names.
Signal Value	Specifies the initial value of the signal.
Description	Text that describes the signal. When creating multiple signals, all will have the same description.
Auto-reset	Specifies that a digital signal should have transient behavior. This applies to digital signals only. Indicates that the signal value is automatically reset to 0.
Number of Signals	Specifies the number of signals to create.
Start Index	Specifies the first suffix when creating multiple signals.
Step	Specifies the suffix interval when creating multiple signals.
Minimum	Specifies the minimum value for an analog signal. This applies to Analog signal only.
Maximum	Specifies the maximum value for an analog signal. This applies to Analog signal only.

Continues on next page

Control	Description
Hidden	Indicates if the property should not be visible in GUI such as the Property Editor and I/O Simulator.
Read only	Indicates if the property value should be possible to modify in GUI such as the Property Editor and I/O Simulator.

**Note**

When editing an existing signal, only the **Signal Value** and **Description** can be modified, while all other controls are locked.

If the input is valid, **OK** is enabled allowing you to create or update the signal. If not, an error icon is displayed.

Expose Child signal

The **Expose Child Signal** dialog box allows you to add a new I/O signal that is connected to a signal in a child object.

The following controls are available:

Control	Description
Signal Name	Specifies the name of the signal to be created. By default, it is the same as the name of the selected child signal.
Child Object	Specifies the object for which to expose a signal.
Child Signal	Specifies the child signal.

I/O Connections

The **I/O Connections** contained in the component are displayed in a grid.

The following controls are available:

Control	Description
Add I/O Connection	Opens the Add I/O Connection dialog box.
Edit	Opens the Edit I/O Connection dialog box.
Manage I/O Connections	Opens the Manage I/O Connections dialog box.
Delete	Deletes the selected connection.
Move Up or Move Down	Sorts by moving the selected connections up and down the list.

Add or Edit I/O Connection

The **Add I/O Connection** dialog box allows you to create an I/O connection or edit an existing connection.

The following controls are available:

Control	Description
Source Object	Specifies the owner of the source signal.
Source Signal	Specifies the source of the connection. The source must either be an output from a child component, or an input to the current component.
Target Object	Specifies the owner of the target signal.

Continues on next page

9 Modeling tab

9.4.5 The Signals and Connections tab

Continued

Control	Description
Target Signal	Specifies the target of the connection. The target must be of the same type as the source, and either an input to a child component or an output from the current component.
Allow cyclic connection	Allows the target signal to be set two times in the same context, which would otherwise generate an error.

Manage I/O Connections

The Manage I/O Connections dialog box displays a graphical view of the I/O connections of the component.

It allows you to add, remove, and modify connections. Only digital signals are displayed.

The following controls are available:

Control	Description
Source / Target Signals	Lists the signals used in the connections, source signals to the left and target signals to the right. Each signal is specified by the owner object and the signal name.
Connections	Displays connections as an arrow from source to target
Logic Gates	Specifies a logic operator and a delay time. It performs digital logic on input signals.
Add	<ul style="list-style-type: none">• Add Source - Adds a source signal to the left.• Add Target - Adds a target signal to the right.• Add Logic Gate - Adds a logic gate at the center
Remove	Removes the selected signal, connection or logic gate.

Managing I/O connections

Use this procedure to add, remove, and create new I/O connections:

- 1 Click **Add** and select **Add Source** or **Add Target** or **Add Logic Gate** to add a source signal or target signal or logic gate respectively.
- 2 Move the cursor towards the **Source Signal** until a cross hair appears.
- 3 Click and drag the left mouse button towards the logic gate to create a new I/O connection.
- 4 Select the signal, connection, or logic gate and click **Remove** to delete.

9.4.6 The Design tab

Overview

The Design tab displays a graphical view of the structure of the component. It includes the child components, internal connections, properties and bindings. The Smart Component can be organized on the viewing screen and their viewing position will be stored with the station.

Using the Design tab

You can do the following in the Design tab:

Action	Description
Move child components and their positions.	<ul style="list-style-type: none"> Click Auto Arrange to organize the components coherently. Use the Zoom slider to zoom the view.
Select a component from the graphical view.	<p>Connections and bindings are color coded and highlighted to avoid confusion.</p> <p>By default, Show Bindings, Show Connections, and Show unused check-box are selected.</p> <ul style="list-style-type: none"> De-select Show Bindings check-box to hide the bindings. De-select Show Connections check-box to hide the connections. De-select Show unused check-box to hide the unused components.
Create connections and bindings	<ol style="list-style-type: none"> Select the source signal or property. The cursor is displayed as a pen. Drag and drop the cursor on the target signal or property. <p>If the target is valid, a connection and binding is created. If the target is invalid, the cursor changes to "not allowed" symbol.</p>

9 Modeling tab

9.4.7 Basic Smart Components

9.4.7 Basic Smart Components

Overview

The base components represent a complete set of basic building block components. They can be used to build user defined Smart Components with more complex behavior.

This lists the basic Smart Components available and are described in the following sections:

- [Signals and Properties on page 296](#)
- [Parametric Primitives on page 300](#)
- [Sensors on page 302](#)
- [Actions on page 305](#)
- [Manipulators on page 307](#)
- [Other on page 310](#)

Signals and Properties

LogicGate

The signal Output is set by the logical operation specified in Operator of the two signals InputA and InputB, with the delay specified in Delay.

Properties	Description
Operator	The logical operator to use. The following lists the various operators: <ul style="list-style-type: none">• AND• OR• XOR• NOT• NOP
Delay	Time to delay the output signal.
Signals	Description
InputA	The first input.
InputB	The second input.
Output	The result of the logic operation.

LogicExpression

Evaluates a logic expression.

Properties	Description
String	The expression to evaluate.
Operator	The following lists the various operators: <ul style="list-style-type: none">• AND• OR• NOT• XOR

Continues on next page

Signals	Description
Result	Contains the result of the evaluation.

LogicMux

Output is set according to: $Output = (Input\ A * NOT\ Selector) + (Input\ B * Selector)$

Signals	Description
Selector	When low, the first input is selected. When high, the second input is selected.
InputA	Specifies the first input.
InputB	Specifies the second input.
Output	Specifies the result of the operation.

LogicSplit

The LogicSplit takes Input and sets OutputHigh to the same as Input, and OutputLow as the inverse of Input.

PulseHigh sends a pulse when Input is set to high, and PulseLow sends a pulse when Input is set to low.

Signals	Description
Input	Specifies the input signal.
OutputHigh	Goes high (1) when input is 1.
OutputLow	Goes high (1) when input is 0.
PulseHigh	Sends pulse when input is set to high.
PulseLow	Sends pulse when input is set to low.

LogicSRLatch

TheLogicSRLatch has one stable state.

- When Set=1, Output=1 and InvOutput=0
- When Reset=1, Output=0 and InvOutput=1

Signals	Description
Set	Sets the output signal.
Reset	Resets the output signal.
Output	Specifies output signal.
InvOutput	Specifies Inverse output signal.

Converter

Converts between property values and signal values.

Properties	Description
AnalogProperty	Converts to AnalogOutput.
DigitalProperty	Converts to DigitalOutput.
GroupProperty	Converts to GroupOutput.
BooleanProperty	Converts from DigitalInput and to DigitalOutput.

Continues on next page

9 Modeling tab

9.4.7 Basic Smart Components

Continued

Signals	Description
DigitalInput	Converts to DigitalProperty.
DigitalOutput	Converted from DigitalProperty.
AnalogInput	Converts to AnalogProperty.
AnalogOutput	Converted from AnalogProperty.
GroupInput	Converts to GroupProperty.
GroupOutput	Converted from GroupProperty.

VectorConverter

Converts between Vector3 and X, Y, and Z values.

Properties	Description
X	Specifies the X-value of Vector.
Y	Specifies the Y-value of Vector.
Z	Specifies the Z-value of Vector
Vector	Specifies the vector value..

Expression

The Expression consists of numeric literals (including PI), parentheses, mathematical operators +, -, *, /, ^ (power) and mathematical functions sin, cos, sqrt, atan, abs. Any other strings are interpreted as variables, which are added as additional properties. The result is displayed in Result.

Signals	Description
Expression	Specifies the expression to evaluate.
Result	Specifies the result of evaluation.
NNN	Specifies automatically generated variables.

Comparer

The Comparer compares First value with Second value, using Operator. Output is set to 1 if the condition is met.

Properties	Description
ValueA	Specifies the first value.
ValueB	Specifies the second value.
Operator	Specifies the comparison operator. The following lists the various operators: <ul style="list-style-type: none">• ==• !=• >• >=• <• <=

Signals	Description
Output	True if the comparison evaluates to true, otherwise false.

Continues on next page

Counter

Count is increased when the input signal Increase is set, and decreased when the input signal Decrease is set. Count is reset when the input signal Reset is set.

Properties	Description
Count	Specifies the current count.

Signals	Description
Increase	Adds one to the Count when set to True.
Decrease	Subtracts one from the Count when set to True.
Reset	Resets the Count to zero when set to high.

Repeater

Pulses Output signal Count number of times.

Properties	Description
Count	Number of times to pulse Output.

Signals	Description
Execute	Set to high (1) to pulse Output Count times.
Output	Output pulse.

Timer

The Timer pulses the Output signal based on the given interval.

If Repeat is unchecked, one pulse will be triggered after the time specified in Interval. Otherwise, the pulse will be repeated at the interval given by Interval.

Properties	Description
StartTime	Specifies the time to pass before the first pulse.
Interval	Specifies the simulation time between the pulses.
Repeat	Specifies if the signal should be pulsed repeatedly or only once.
Current time	Specifies the current simulation time.

Signals	Description
Active	Set to True to activate the timer, and False to deactivate it.
Output	Sends pulses at the specified time intervals.

StopWatch

The StopWatch measures time during simulation (TotalTime). A new lap can be started by triggering the Lap input signal. LapTime shows the current lap time. The time is only measured when Active is set to 1. The times are reset when the input signal Reset is set.

Properties	Description
TotalTime	Specifies the accumulated time.
LapTime	Specifies the current lap time.
AutoReset	If true, TotalTime and LapTime will be set to 0 when the simulation starts.

Continues on next page

9 Modeling tab

9.4.7 Basic Smart Components

Continued

Signals	Description
Active	Set to True to activate the stop watch, and False to deactivate it.
Reset	Resets Total time and Lap time when set to high.
Lap	Starts a new lap.

Parametric Primitives

ParametricBox

The ParametricBox generates a box with dimensions specified by length, width, and height.

Properties	Description
SizeX	Specifies the length of the box in the X-axis direction.
SizeY	Specifies the length of the box in the Y-axis direction.
SizeZ	Specifies the length of the box in the Z-axis direction
GeneratedPart	Specifies the generated part.
KeepGeometry	False to remove the geometry data from the generated part. This can make other components such as Source execute faster.

Signals	Description
Update	Set to high (1) to update the generated part.

ParametricCircle

The ParametricCircle generates a circle with a given radius.

Properties	Description
Radius	Specifies the radius of the circle.
GeneratedPart	Specifies the generated part.
GeneratedWire	Specifies the generated wire object.
KeepGeometry	False to remove the geometry data from the generated part. This can make other components such as Source execute faster

Signals	Description
Update	Set to high (1) to update the generated part.

ParametricCylinder

The ParametricCylinder generates a cylinder with the dimensions given by Radius and Height.

Properties	Description
Radius	Specifies the radius of the cylinder.
Height	Specifies the height of the cylinder.
GeneratedPart	Specifies the generated part.
KeepGeometry	False to remove the geometry data from the generated part. This can make other components such as Source execute faster.

Continues on next page

Signals	Description
Update	Set to high (1) to update the generated part.

ParametricLine

The ParametricLine generates a line with a given end point or a given length. If either of them is changed, the other one will be updated accordingly.

Properties	Description
EndPoint	Specifies the end point for the line.
Length	Specifies the length of the line.
GeneratedPart	Specifies the generated part.
GeneratedWire	Specifies the generated wire object.
KeepGeometry	False to remove the geometry data from the generated part. This can make other components such as Source execute faster.

Signals	Description
Update	Set to high (1) to update the generated part.

LinearExtrusion

The LinearExtrusion extrudes SourceFace or SourceWire along the vector given by Projection.

Properties	Description
SourceFace	Specifies the face to extrude.
SourceWire	Specifies the wire to extrude.
Projection	Specifies the vector to extrude along.
GeneratedPart	Specifies the generated part.
KeepGeometry	False to remove the geometry data from the generated part. This can make other components such as Source execute faster.

CircularRepeater

The CircularRepeater creates a number of given copies of Source around the center of the SmartComponent with a given DeltaAngle.

Properties	Description
Source	Specifies the object to copy.
Count	Specifies the number of copies to create.
Radius	Specifies the radius of the circle.
DeltaAngle	Specifies the angle between the copies.

LinearRepeater

The LinearRepeater creates a number of copies of Source, with the spacing and direction given by Offset.

Properties	Description
Source	Specifies the object to copy.

Continues on next page

9 Modeling tab

9.4.7 Basic Smart Components

Continued

Properties	Description
Offset	Specifies the distance between copies.
Count	Specifies the number of copies to create.

MatrixRepeater

The MatrixRepeater creates a specified number of copies in three dimensions, with the specified spacing of the object in Source.

Properties	Description
Source	Specifies the object to copy.
CountX	Specifies the number of copies in the X-axis direction.
CountY	Specifies the number of copies in the Y-axis direction.
CountZ	Specifies the number of copies in the Z-axis direction.
OffsetX	Specifies the offset between the copies in the X-axis direction.
OffsetY	Specifies the offset between the copies in the Y-axis direction.
OffsetZ	Specifies the offset between the copies in the Z-axis direction.

Sensors

CollisionSensor

The CollisionSensor detects collisions and near miss events between the First object and the Second object. If one of the objects is not specified, the other will be checked against the entire station. When the Active signal is high and a collision or a near miss event occurs and the component is active, the SensorOut signal is set and the parts that participate in the collision or near miss event are reported in the first colliding part and second colliding part of the Property editor.

Properties	Description
Object1	The first object to check for collisions.
Object2	The second object to check for collisions.
NearMiss	Specifies the near miss distance.
Part1	The part of First object that has a collision.
Part2	The part of Second object that has a collision.
CollisionType	<ul style="list-style-type: none">• None• Near miss• Collision

Signals	Description
Active	Specifies if the CollisionSensor is active or not.
SensorOut	True if there is a NearMiss or Collision.

Continues on next page

LineSensor

The LineSensor defines a line by the Start, End, and Radius. When an Active signal is high, the sensor detects objects that intersect the line. Intersecting objects are displayed in the ClosestPart property and the point on the intersecting part that is closest to the line sensors start point is displayed in the ClosestPoint property. When intersection occurs the SensorOut output signal is set.

Properties	Description
Start	Specifies the start point.
End	Specifies the end point.
Radius	Specifies the radius.
SensedPart	Specifies the part that intersects the line sensor. If several parts intersect, then the one closest to the Start point is listed.
SensedPoint	Specifies the point on the intersecting part, closest to the Start point.

Signals	Description
Active	Specifies if the LineSensor is active or not.
SensorOut	True if the sensor intersects with an object.

PlaneSensor

The PlaneSensor defines a plane by Origin, Axis1, and Axis2. When the Active input signal is set the sensor detects objects that intersect this plane. Intersecting objects are displayed in the SensedPart property and when intersection occurs the SensorOut output signal is set.

Properties	Description
Origin	Specifies the origin of the plane.
Axis1	Specifies the first axis of the plane.
Axis2	Specifies the second axis of the plane.
SensedPart	Specifies the part that intersects the PlaneSensor. If several parts intersect, then the one listed first in the Layout browser is selected.

Signals	Description
Active	Specifies if the PlaneSensor is active or not.
SensorOut	True if the sensor intersects with an object.

VolumeSensor

The VolumeSensor detects objects that are inside or partly inside a box-shaped volume. The volume is defined by a Corner Point, the Length, Height, and Width of the sides and the orientation angles.

Properties	Description
CornerPoint	Specifies the local origin of the box.
Orientation	Specifies the orientation (Euler ZYX) relative to Reference.
Length	Specifies the length of the box.

Continues on next page

9 Modeling tab

9.4.7 Basic Smart Components

Continued

Properties	Description
Width	Specifies the width of the box.
Height	Specifies the height of the box.
Percentage	The percentage of the volume to react on. Set to 0 to react on all objects.
PartialHit	Allow an object to be sensed if only a part of it is inside the volume sensor.
SensedPart	The last object that either entered or left the volume.
SensedParts	The objects sensed in the volume
VolumeSensed	The total volume sensed

Signals	Description
Active	Set to high (1) to activate the sensor.
ObjectDetectedOut	Goes high (1) when an object is detected within the volume. Is reset immediately after an object has been detected.
ObjectDeletedOut	Goes high (1) when an object is detected to leave the volume. Is reset immediately after an object has left the volume.
SensorOut	Goes high (1) when the volume is full.

PositionSensor

The PositionSensor monitors the position and orientation of an object.

The position and orientation of an object is updated only during the simulation.

Properties	Description
Object	Specifies the object to monitor.
Reference	Specifies the reference coordinate system (Parent or Global).
ReferenceObject	Specifies the reference object, if Reference is set to Object.
Position	Specifies the position of the object relative to Reference.
Orientation	Specifies the orientation (Euler ZYX) relative to Reference.

ClosestObject

The ClosestObject defines a Reference object or a Reference point. When the Execute signal is set, the component finds the ClosestObject, ClosestPart, and the Distance to the reference object, or to the reference point if the reference object is undefined. If RootObject is defined, the search is limited to that object and its descendants. When finished and the corresponding properties are updated the Executed signal is set.

Properties	Description
ReferenceObject	Specifies the object to get the closest object to.
ReferencePoint	Specifies the point to get the closest object to.
RootObject	Specifies the object whose children to search. Empty means entire station.
ClosestObject	Specifies the object closest to Reference object or Reference point.

Continues on next page

Properties	Description
ClosestPart	Specifies the part closest to Reference object or Reference point.
Distance	Specifies the distance between the Reference object and the Closest object.

Signals	Description
Execute	Set to True to find the Closest part.
Executed	Sends a pulse when completed.

Actions

Attacher

The Attacher will attach Child to Parent when the Execute signal is set. If the Parent is a mechanism, the Flange to attach to must also be specified. When the input Execute is set, the child object is attached to the parent object. If Mount is checked, the child will also be mounted on the parent, with the Offset and Orientation specified. The output Executed will be set when finished.

Properties	Description
Parent	Specifies the object to attach to.
Flange	Specifies the Index of mechanism flange to attach to.
Child	Specifies the object to attach.
Mount	If true, the object to attach mounts on the attachment parent.
Offset	Specifies the position relative to the attachment parent when using Mount.
Orientation	Specifies the orientation relative to the attachment parent when using Mount.

Signals	Description
Execute	Set to True to attach.
Executed	Sends a pulse when completed.

Detacher

The Detacher will detach the Child from the object it is attached to when the Execute signal is set. If Keep position is checked, the position will be kept. Otherwise the child is positioned relative to its parent. When finished, the Executed signal will be set.

Properties	Description
Child	Specifies the object to detach.
KeepPosition	If false, the attached object is returned to its original position.

Signals	Description
Execute	Set to True to remove the attachment.
Executed	Sends a pulse when completed.

Continues on next page

9 Modeling tab

9.4.7 Basic Smart Components

Continued

Source

The Source property of the source component indicates the object that should be cloned when the Execute input signal is received. The parent of the cloned objects is specified by the Parent property and a reference to the cloned object is specified by the Copy property. The output signal Executed signifies that the clone is complete.

Properties	Description
Source	Specifies the object to copy.
Copy	Specifies the copied object.
Parent	Specifies the parent to the copy. If not specified, the copy gets the same parent as the source.
Position	Specifies the position of the copy relative its parent.
Orientation	Specifies the orientation of the copy relative its parent.
Transient	Marks the copy as transient if created during simulation. Such copies are not added to the undo queue and are automatically deleted when the simulation is stopped. This is used to avoid increased memory consumption during simulation.

Signals	Description
Execute	Set to True to create a copy of the object.
Executed	Sends a pulse when completed.

Sink

The Sink deletes the object referenced by the Object property. Deletion happens when the Execute input signal is received. The Executed output signal is set when the deletion is finished.

Properties	Description
Object	Specifies the object to remove.

Signals	Description
Execute	Set to True to remove the object.
Executed	Sends a pulse when completed.

Show

When the Execute signal is set, the object referenced in Object appears. When finished, Executed signal will be set.

Properties	Description
Object	Specifies the object to show.

Signals	Description
Execute	Set to True to show the object.
Executed	Sends a pulse when completed.

Continues on next page

Hide

When the Execute signal is set, the object referenced in Object will be hidden. When finished, Executed signal will be set.

Properties	Description
Object	Specifies the object to hide.

Signals	Description
Execute	Set to True to hide the object.
Executed	Sends a pulse when completed.

Manipulators**LinearMover**

The LinearMover moves the object referenced in the Object property with a speed given by the Speed property in the direction given by the Direction property. The motion starts when the Execute input signal is set and stops when Execute is reset.

Properties	Description
Object	Specifies the object to move.
Direction	Specifies the direction to move the object.
Speed	Specifies the speed of movement.
Reference	Specifies the coordinate system in which values are specified. It can be Global, Local, or Object.
ReferenceObject	Specifies the reference object, if Reference is set to Object.

Signals	Description
Execute	Set to True to start move the object, and False to stop.

Rotator

The Rotator rotates the object referenced in the Object property with an angular speed given by the Speed property. The axis of rotation is given by CenterPoint and Axis. The motion starts when the Execute input signal is set and stops when the Execute is reset.

Properties	Description
Object	Specifies the object to rotate.
CenterPoint	Specifies the point to rotate around.
Axis	Specifies the axis of the rotation.
Speed	Specifies the speed of the rotation.
Reference	Specifies the coordinate system in which values are specified. It can be Global, Local, or Object.
ReferenceObject	Specifies the object which are relative to CenterPoint and Axis, if Reference is set to Object.

Signals	Description
Execute	Set to True to start rotating the object, and False to stop.

Continues on next page

9 Modeling tab

9.4.7 Basic Smart Components

Continued

Positioner

The Positioner takes an Object, Position, and Orientation as properties. When the Execute signal is set the object is repositioned in the given position relative to the Reference. When finished the Executed output is set.

Properties	Description
Object	Specifies the object to position.
Position	Specifies the new position of the object.
Orientation	Specifies the new orientation of the object.
Reference	Specifies the coordinate system in which values are specified. It can be Global, Local, or Object.
ReferenceObject	Specifies the object which are relative to Position and Orientation, if Reference is set to Object.

Signals	Description
Execute	Set to True to start move the object, and False to stop.
Executed	Set to 1 when operation is completed.

PoseMover

The PoseMover has a Mechanism, a Pose, and Duration as properties. When the Execute input signal is set the mechanism joint values are moved to the given pose. When the pose is reached the Executed output signal is set.

Properties	Description
Mechanism	Specifies the mechanism to move to a pose.
Pose	Specifies the Index of the pose to move to.
Duration	Specifies the time for the mechanism to move to the pose.

Signals	Description
Execute	Set to True, to start or resume moving the mechanism.
Pause	Pauses the movement.
Cancel	Cancels the movement.
Executed	Pulses high when the mechanism has reached the pose.
Executing	Goes high during the movement.
Paused	Goes high when paused.

JointMover

The JointMover has a Mechanism, a set of Joint Values and a Duration as properties. When the Execute input signal is set the mechanism joint values are moved to the given pose. When the pose is reached the Executed output signal is set. The GetCurrent signal retrieves the current joint values of the mechanism.

Properties	Description
Mechanism	Specifies the mechanism to move to a pose.
Relative	Specifies if J1-Jx are relative to the start values, rather than absolute joint values.
Duration	Specifies the time for the mechanism to move to the pose.

Continues on next page

Properties	Description
J1 - Jx	Joint values.

Signals	Description
GetCurrent	Retrieve current joint values.
Execute	Set to True to start moving the mechanism.
Pause	Pauses the movement
Cancel	Cancels the movement
Executed	Pulses high when the mechanism has reached the pose.
Executing	Goes high during the movement.
Paused	Goes high when paused.

Controller

RapidVariable

Sets or gets the value of a RAPID variable.

Properties	Description
DataType	RAPID datatype of the variable to get or set (bool, num, dnum, string, pos, orient, or pose)
Controller	The virtual controller that contains the variable.
Task	The RAPID task that contains the variable.
Module	The RAPID module in which the variable is defined.
Variable	The name of the RAPID variable
Value	The variable value and the type depends on DataType.

Signals	Description
Get	Set to high to get the value from the controller to the smart component.
Set	Set to high to set the value from the smart component to the controller.
Executed	Is pulsed when the value is updated

Physics

PhysicsControl

Controls the physics related properties of parts or component groups.

Properties	Description
Object	Specifies the object to control.
Behavior	Determines the behavior of the object in the physics simulation.
Surface Velocity	Sets the surface velocity.

Signals	Description
Enabled	Set to high to apply the defined properties.

Continues on next page

9 Modeling tab

9.4.7 Basic Smart Components

Continued

Other

GetParent

The GetParent returns the parent object of the input object. The executed signal is triggered if a parent is found.

Properties	Description
Child	Specifies the object to whose parent is to be found.
Parent	Specifies the parent of the child

Signals	Description
Output	Goes high (1) if the parent exists.



Note

The **Child** list for **Properties:GetParent** does not show every part or object in the station. However, if you do not find the required part or object in the list, then add it from the browser or graphic window by clicking it.

GraphicSwitch

Switches between two parts, either by clicking on the visible part in the graphics or by setting and resetting the input signal.

Properties	Description
PartHigh	Displayed when the signal is high.
PartLow	Displayed when the signal is low.

Signals	Description
Input	Input signal.
Output	Output signal.

Highlighter

The Highlighter temporarily sets the color of the Object to the RGB-values specified in Color. The color is blended with the original color of the objects as defined by Opacity. When the signal Active is reset, Object gets its original colors.

Properties	Description
Object	Specifies the object to highlight.
Color	Specifies the RGB-values of the highlight color.
Opacity	Specifies the amount to blend with the object's original color (0-255).

Signals	Description
Active	True sets the highlight. False restores the original color.

Continues on next page

Logger

Prints a message in the output window.

Properties	Description
Format	Format string. Supports variables like {id:type}, where type can be d (double), i (int), s (string), o (object)
Message	Formatted message.
Severity	Message severity: 0 (Information), 1 (Warning), 2 (Error).
Signals	Description
Execute	Set to high (1) to print the message.

MoveToViewPoint

Moves to the selected viewpoint in the given time, when the input signal Execute is set. The output signal Executed is set when the operation is completed.

Properties	Description
Viewpoint	Specifies the viewpoint to move to.
Time	Specifies the time to complete the operation.
Signals	Description
Execute	Set to high (1) to start the operation.
Executed	Goes high (1) when the operation is completed.

ObjectComparer

Determines if ObjectA is the same as ObjectB.

Properties	Description
ObjectA	Specifies the object to compare.
ObjectB	Specifies the object to compare.
Signals	Description
Output	Goes high if the objects are equal.

Queue

The Queue represents a FIFO (first in, first out) queue. The object in Back is added to the queue when the signal Enqueue is set. The front object of the queue is shown in Front. The object in Front is removed from the queue when the signal Dequeue is set. If there are more objects in the queue, the next object is shown in Front. All objects in the queue are removed from the queue when the signal Clear is set.

If a transformer component (such as LinearMover) has a queue component as its Object, it will transform the contents of the queue, rather than the queue itself.

Properties	Description
Back	Specifies the object to enqueue.
Front	Specifies the first object in queue.
Queue	Contains unique IDs of the queue's elements.

Continues on next page

9 Modeling tab

9.4.7 Basic Smart Components

Continued

Properties	Description
NumberOfObjects	Specifies the number of objects in the queue.

Signals	Description
Enqueue	Adds the object in Back to the end of the queue.
Dequeue	Removes the object in Front from the queue.
Clear	Removes all objects from the queue.
Delete	Removes the object in Front from the queue and from the station.
DeleteAll	Clears the queue and removes all objects from the station

SoundPlayer

Plays the sound specified by Sound Asset when the input signal Execute is set. The asset must be a .wav file

Properties	Description
SoundAsset	Specifies the sound file that should be played. Must be a .wav file.

Signals	Description
Execute	Set to high to play the sound.

StopSimulation

Stop a running simulation when the input signal Execute is set.

Signals	Description
Execute	Set to high to stop the simulation.

Random

Random generates a random number between Min and Max in Value when Execute is triggered.

Properties	Description
Min	Specifies minimum value.
Max	Specifies maximum value.
Value	Specifies a random number between Min and Max.

Signals	Description
Execute	Set to high to generate a new random number.
Executed	Goes high when the operation is completed.

9.4.8 Property Editor

Overview

The Property editor is used to modify the values of dynamic properties and I/O signals for a Smart Component. By default, the Property editor is displayed as a tool window to the left.

Each dynamic property is represented by a control. The type of control that is displayed depends on the property type and property attributes.

Properties with the Hidden flag set to true are not displayed. Read-only properties cannot be modified but are only displayed.

The values are validated according to the property attributes. If an invalid value is entered, an error icon is displayed next to the control and the **Apply** button is disabled.

If you set the **AutoApply** attribute of a property to true, the value is applied whenever you change the value in the control. You can apply the values of other properties by clicking the **Apply** button. If the component has no properties without **AutoApply**, then the **Apply** button will never be enabled.

You can toggle the value of a digital signal by clicking the control. Similarly, you can change the value of an analog or group signal by entering the new value in the text box.

Opening the Property editor

You can open the Property editor dialog box in any one of the following ways:

- Right-click context menu for a Smart Component and select **Properties**.
- Launches automatically when the Smart Component Editor is started.
- Launched when you add a base component. See [Basic Smart Components on page 296](#).

9 Modeling tab

9.4.9 The Simulation Watch window

9.4.9 The Simulation Watch window

Overview

The Simulation Watch allows you to monitor the values of dynamic properties and I/O signals in Smart Components. It specifies the simulation that should be paused when a value changes or meets a condition.

Layout of the Simulation Watch window

The Simulation Watch window by default takes the lower tab area in the RobotStudio GUI.

The window contains a list view of four columns with one row for each watch item:

Watch item	Description
Break	Specifies the Simulation break point and Break Condition. For more information, see Setting Breakpoints on page 315 .
Object	Specifies the object that owns the property or signal (for station signals the name of the station is displayed).
Property/Signal	Specifies the watched property or signal.
Value	Specifies the current value of the property or signal.

Adding and Deleting the Watch items

Use this procedure to add or delete a watch item.



Note

As a prerequisite, you should add smart component, its properties and signals. For more information, see [Smart Component Editor on page 285](#).

- 1 In the **Simulation Watch** window, right-click and select **Add** to display the Add submenu.

The Add submenu displays a recursive view of all the smart components, their properties and signals. The top level submenu displays the station signals.



Note

Watch items that are already watched are not displayed in the recursive view.

- 2 From the Add submenu, select property or signal to add a single property or signal of a component.
- 3 From the Add submenu, select **Add all** to add all the properties and signals of a component.

Continues on next page

- 4 In the **Simulation Watch** window, right-click on the row of the watch item and select **Delete** to delete one or more watch items.

**Note**

The Watch items are saved in the station and are restored when the station is opened.

Setting Breakpoints

You can set the breakpoint in one of the following ways:

- 1 To set the simulation breakpoint, select the check box next to a watch item.

**Note**

By default, the simulation is paused whenever the value of the property or signal changes.

- 2 In the **Simulation Watch** window, right-click on the row of the watch item and select **Break Condition**.

The **Break Condition** dialog box appears.

- Set the simulation to paused, when the value meets a certain logical condition. The condition can be viewed in the **Break** column of the Watch window.
- When a breakpoint is reached, the simulation is paused which is indicated by both the Play and Stop buttons being enabled.
- If the **Simulation Watch** window is hidden behind the other windows, it is brought to the front and the text of the corresponding watch item turns red.

**Note**

- Break condition can be specified only for the properties of numeric and string types, and not for the object types.
- After the current simulation time step is completed, all the remaining Smart component events are executed before the simulation is actually paused.

9.5 Tags

Overview

For a complex RobotStudio station containing many robots, parts, paths, targets and other objects the browser and the 3D graphics view becomes cluttered. Tags function helps the user to identify objects in the cluttered 3D graphics view and in the browser during station modeling and offline programming.

Using tags function, you can group objects in a defined structure by labeling them. It is possible to hide or show these tags independent of the other tags. A hidden tagged object is invisible in the browser and in the 3D graphics window unless it is labeled by a currently visible tag.



Tip

For easy and quick access of Tags function, add it to the **Quick Access Toolbar** using the customize Commands.

Creating a New Tag

Use any of the following steps to create a new tag.

- In the **Modeling** tab, select **Tags** and then click **New Tag**.
- Right-click the object and in the context menu, click **Tags** and then click **New Tag**. The object will be labeled by the tag

The new tag appears in the browser with the default name. Press F2 and select **Rename** from the context menu to rename the tag.

Use any of the following steps to hide or show tagged objects.

- In the **Tag** browser, right-click the tag and then check/uncheck **Visible**.
- Click the **Tags** menu and then check/uncheck the tag to show/hide the tag.

Tag Visibility

When a tag is invisible/ unchecked, the corresponding tagged object will be hidden in the 3D graphics view and in the browsers (layout, path and targets, modeling). If an object is labeled by several tags, the object will be visible when at least one of the tags is set visible. Untagged objects are always visible.



Note

The regular visible property remains and overrides the tag visibility. If regular visible property is unchecked for an object, the object will be hidden in the 3D graphics view but it is visible in the browser. For a tagged object, when the visibility is unchecked, the object will be hidden in the 3D graphics view and in the browser.

9.6 Selection of Objects

Overview

In 3D view, you can select an object by drawing a selection rectangle using a mouse cursor.

Deep rectangle selection

The Deep rectangle selection (default selection mode) is enabled if you press and hold the `SHIFT` key and draw a rectangle in the 3D view using the mouse. This mode selects objects covered by the selection rectangle regardless of its visibility.

Shallow rectangle selection

Shallow rectangle selection is enabled if you press `SHIFT + S` keys and draw a rectangle in the 3D view using the mouse. In this mode, you can optionally select the currently visible object.

9 Modeling tab

9.7 Solid

9.7 Solid

Creating a solid

- 1 Click **Solid** and then click the type of solid you want to create to bring up a dialog box.
- 2 Enter requested values in the dialog box and click **Create**. For detailed information about the specific dialog box for the curve to create, see below:

The Create Box dialog box

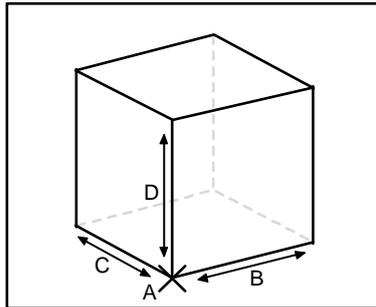

xx060000

Reference	Select the Reference coordinate system to which all positions or points will be related.
Corner Point (A)	Click in one of these boxes, and then click the corner point in the graphics window to transfer the values to the Corner Point boxes, or type the position. The corner point will be the local origin of the box.
Orientation	If the object shall be rotated relative to the reference coordinate system, specify the rotation.
Length (B)	Specify the box dimension along its X axis.
Width (C)	Specify the box dimension along its Y axis.
Height (D)	Specify the box dimension along its Z axis.

The Create Box from 3-Points dialog box

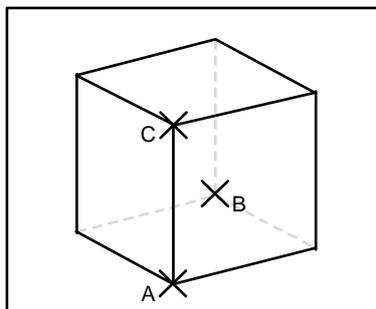

xx060001

Reference	Select the Reference coordinate system to which all positions or points will be related.
------------------	---

Continues on next page

Corner Point (A)	This point will be the local origin of the box. Either type the position, or click in one of the boxes and then select the point in the graphics window.
Point on diagonal of XY-plane (B)es	This point is the the corner, diagonal to the local origin. It sets the X and Y directions of the local coordinate system, as well as the dimension of the box along these axes. Either type the position, or click in one of the boxes and then select the point in the graphics window.
Indication Point Z-axis (C)	This point is the corner above the local origin, It sets the Z direction of the local coordinate system, as well as the dimension of the box along the Z axis. Either type the position, or click in one of the boxes and then select the point in the graphics window.

The Create Cone dialog box

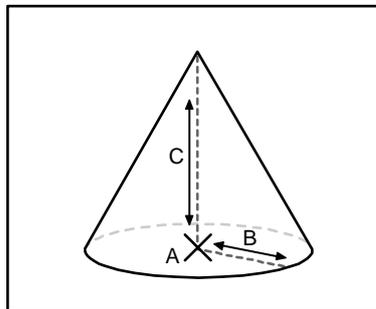

xx060002

Reference	Select the Reference coordinate system to which all positions or points will be related.
Base Center Point (A)	Click in one of these boxes, and then click the center point in the graphics window to transfer the values to the Base Center Point boxes, or type the position. The center point will be the local origin of the cone.
Orientation	If the object shall be rotated relative to the reference coordinate system, specify the rotation.
Radius (B)	Specify the radius of the cone.
Diameter	Specify the diameter of the cone.
Height (C)	Specify the height of the cone.

The Create Cylinder dialog box

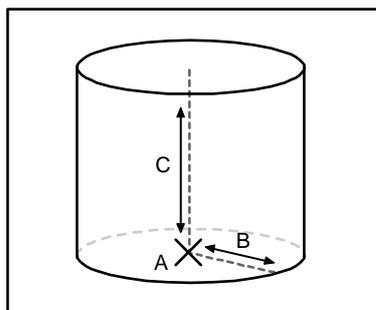

xx060003

Continues on next page

9 Modeling tab

9.7 Solid Continued

Reference	Select the Reference coordinate system to which all positions or points will be related.
Base Center Point (A)	Click in one of these boxes, and then click the center point in the graphics window to transfer the values to the Base Center Point boxes, or type the position. The center point will be the local origin of the cylinder.
Orientation	If the object shall be rotated relative to the reference coordinate system, specify the rotation.
Radius (B)	Specify the radius of the cylinder.
Diameter	Specify the diameter of the cylinder.
Height (C)	Specify the height of the cylinder.
Create Capsule	Select the checkbox to create a cylinder with rounded ends.

The Create Pyramid dialog box

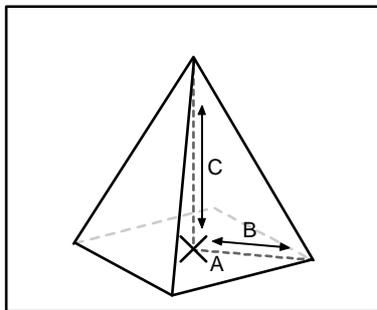

xx060004

Reference	Select the Reference coordinate system to which all positions or points will be related.
Base Center Point (A)	Click in one of these boxes, and then click the center point in the graphics window to transfer the values to the Base Center Point boxes, or type the position. The center point will be the local origin of the pyramid.
Orientation	If the object shall be rotated relative to the reference coordinate system, specify the rotation.
Center to Corner Point (B)	Either type the position, or click in the box and then select the point in the graphics window.
Height (C)	Specify the height of the pyramid.
Number of Sides	Specify the number of sides of the pyramid. The maximum number of sides is 50.

Continues on next page

The Create Sphere dialog box

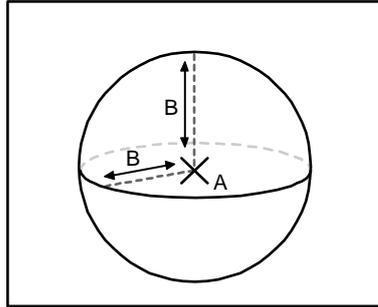

xx060005

Reference	Select the Reference coordinate system to which all positions or points will be related.
Center Point (A)	Click in one of these boxes, and then click the center point in the graphics window to transfer the values to the Center Point boxes, or type the position. The center point will be the local origin of the sphere.
Radius (B)	Specify the radius of the sphere.
Diameter	Specify the diameter of the sphere.

9 Modeling tab

9.8 Surface

9.8 Surface

Creating a surface

- 1 Click **Surface** and then click the type of solid you want to create to bring up a dialog box.
- 2 Enter requested values in the dialog box and click **Create**. For detailed information about the specific dialog box for the curve to create, see below:

The Create Surface Circle dialog box

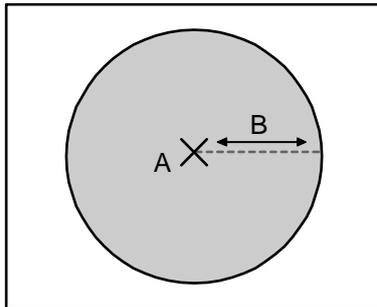

xx060006

Reference	Select the Reference coordinate system, to which all positions or points will be related.
Center Point (A)	Click in one of these boxes, and then click the center point in the graphics window to transfer the values to the Center Point boxes, or type the position. The center point will be the local origin of the circle.
Orientation	If the object shall be rotated relative to the reference coordinate system, specify the rotation.
Radius (B)	Specify the radius of the circle.
Diameter	Specify the diameter of the circle.

The Create Rectangle dialog box

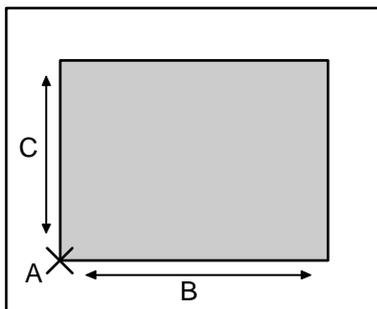

xx060007

Reference	Select the Reference coordinate system to which all positions or points will be related.
Start Point (A)	Click in one of these boxes, and then click the center point in the graphics window to transfer the values to the Start Point boxes, or type the position. The start point will be the local origin of the rectangle.

Continues on next page

Orientation	If the object shall be rotated relative the reference coordinate system, specify the rotation.
Length (B)	Specify the length of the rectangle.
Width (C)	Specify the width of the rectangle

The Create Surface Polygon dialog box

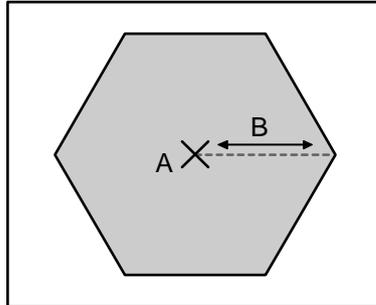

xx060008

Reference	Select the Reference coordinate system to which all positions or points will be related.
Center Point	Click in one of these boxes, and then click the center point in the graphics window to transfer the values to the Center Point boxes, or type the position. The center point will be the local origin of the polygon.
First Vertex Point	Either type the position, or click in one of the boxes and then select the point in the graphics window.
Vertices	Specify the number of the vertices here. The maximum number of vertices is 50.

The Create Surface from Curve dialog box

Select Curve from graphics	Select a curve by clicking it in the graphics window.
-----------------------------------	---

9 Modeling tab

9.9 Curve

9.9 Curve

Creating a curve

- 1 Click **Curve** and then click the curve you want to create to bring up a dialog box.
- 2 Enter requested values in the dialog box and click **Create**. For detailed information about the specific dialog box for the curve to create, see below:

The Create Line dialog box

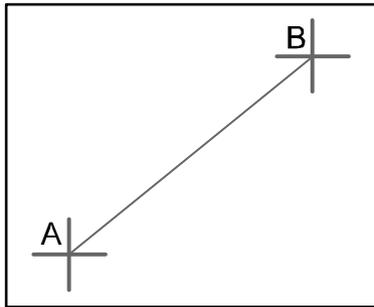

xx050034

Reference	Select the Reference coordinate system to which all positions or points will be related.
Start point (A)	Click in one of these boxes, and then click the start point in the graphics window to transfer the values to the Start Point boxes.
End Point (B)	Click in one of these boxes, and then click the end point in the graphics window to transfer the values to the End Point boxes.

The Create Circle dialog box

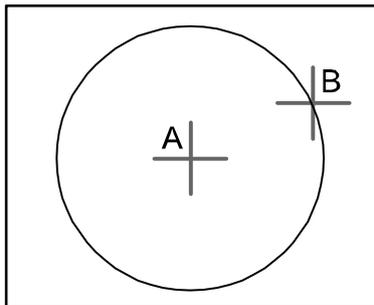

xx050035

Reference	Select the Reference coordinate system to which all positions or points will be related.
Center point (A)	Click in one of these boxes, and then click the center point in the graphics window to transfer the values to the Center Point boxes.
Orientation	Specify the orientation coordinates for the circle.
Radius (A-B)	Specify the radius of the circle.
Diameter	Alternatively, specify the diameter.

Continues on next page

The Create Three Points Circle dialog box

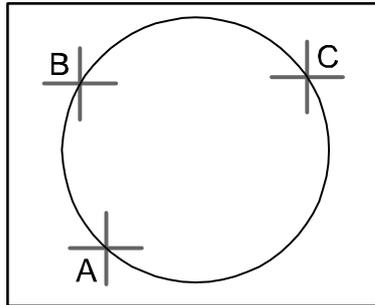

xx050036

Reference	Select the Reference coordinate system to which all positions or points will be related.
First Point (A)	Click in one of these boxes, and then click the first point in the graphics window to transfer the values to the First Point boxes.
Second Point (B)	Click in one of these boxes, and then click the second point in the graphics window to transfer the values to the Second Point boxes.
Third Point (C)	Click in one of these boxes, and then click the third point in the graphics window to transfer the values to the Third Point boxes.

The Create Arc dialog box

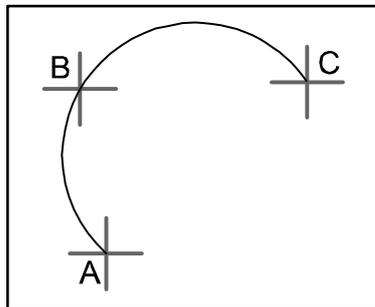

xx050037

Reference	Select the Reference coordinate system to which all positions or points will be related.
Start Point (A)	Click in one of these boxes, and then click the start point in the graphics window to transfer the values to the Start Point boxes.
Mid Point (B)	Click in one of these boxes, and then click the second point in the graphics window to transfer the values to the Mid Point boxes.
End Point (C)	Click in one of these boxes, and then click the end point in the graphics window to transfer the values to the End Point boxes.

Continues on next page

9 Modeling tab

9.9 Curve Continued

The Create Elliptical Arc dialog box

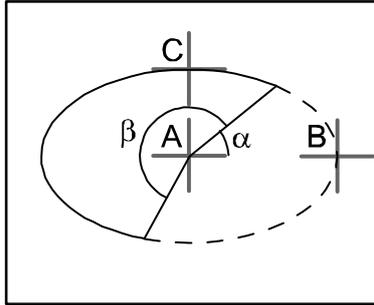

xx050038

Reference	Select the Reference coordinate system to which all positions or points will be related.
Center Point (A)	Click in one of these boxes, and then click the center point in the graphics window to transfer the values to the Center Point boxes.
Major Axis End Point (B)	Click in one of these boxes, and then click the end point for the major axis of the ellipse in the graphics window to transfer the values to the Major Axis End Point boxes.
Minor Axis End Point (C)	Click in one of these boxes, and then click the end point for the minor axis of the ellipse in the graphics window to transfer the values to the Minor Axis End Point boxes.
Start Angle (α)	Specify the start angle for the arc, measured from the major axis.
End Angle (β)	Specify the end angle for the arc, measured from the major axis.

The Create Ellipse dialog box

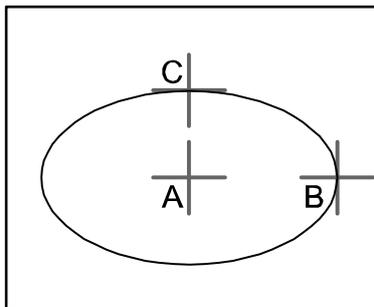

xx050039

Reference	Select the Reference coordinate system to which all positions or points will be related.
Center Point (A)	Click in one of the Center Point boxes, and then click the center point in the graphics window to transfer the values to the Center Point boxes.
Major Axis End Point (B)	Click in one of these boxes, and then click the end point for the major axis of the ellipse in the graphics window to transfer the values to the Major Axis End Point boxes.
Minor Radius (C)	Specify the length of the minor axis of the ellipse. The minor radius will be created perpendicular to the major axis.

Continues on next page

The Create Rectangle dialog box

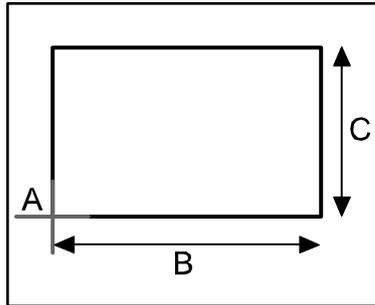

xx050040

Reference	Select the Reference coordinate system to which all positions or points will be related.
Start Point (A)	Click in one of these boxes, and then click the start point in the graphics window to transfer the values to the Start Point boxes. The rectangle will be created in the positive coordinate directions.
Orientation	Specify the orientation coordinates for the rectangle.
Length (B)	Specify the length of the rectangle along the x axis.
Width (C)	Specify the width of the rectangle along the y axis.

The Create Polygon dialog box

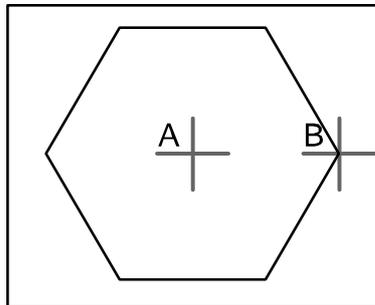

xx050041

Reference	Select the Reference coordinate system to which all positions or points will be related.
Center Point (A)	Click in one of these boxes, and then click the center point in the graphics window to transfer the values to the Center Point boxes.
First Vertex Point (B)	Click in one of these boxes, and then click the first vertex point in the graphics window to transfer the values to the First Vertex Point boxes. The distance between the center point and the first vertex point will be used for all vertex points.
Vertices	Specify the number of points to be used when creating the polygon. The maximum number of vertices is 50.

Continues on next page

9 Modeling tab

9.9 Curve Continued

The Create Polyline dialog box

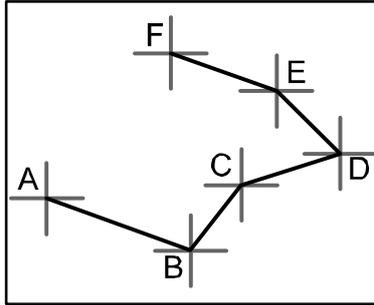

xx050042

Reference	Select the Reference coordinate system to which all positions or points will be related.
Point Coordinates	Specify each node of the polyline here, one at a time, by either typing the values, or by clicking in one of these boxes, and then selecting the point in the graphics window to transfer its coordinates.
Add	Click this button to add a point and its coordinates to the list.
Modify	Click this button to modify an already defined point, after you have selected it in the list and entered new values.
List	The nodes of the polyline. To add more nodes, click Add New , click the desired point in the graphics window, and then click Add .
Create closed curve	Select the checkbox to create a polyline that connects the start and end points.

The Create Spline dialog box

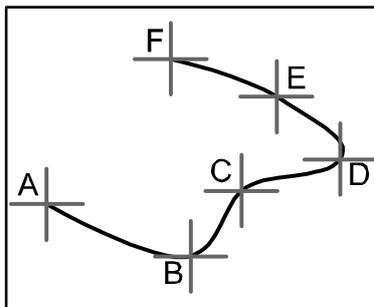

xx050043

Reference	Select the Reference coordinate system to which all positions or points will be related.
Point Coordinates	Specify each node of the spline here, one at a time, by either typing the values, or by clicking in one of these boxes, and then selecting the point in the graphics window to transfer its coordinates.
Add	Click this button to add a point and its coordinates to the list.
Modify	Click this button to modify an already defined point, after you have selected it in the list and entered new values.

Continues on next page

List	This nodes of the spline. To add more nodes, click Add New , click the desired point in the graphics window, and then click Add .
Create closed curve	Select the checkbox to create a spline that connects the first and last node.

9 Modeling tab

9.10 Border

9.10 Border

Creating a curve

- 1 Click **Border** and then click the border you want to create to bring up a dialog box.
 - 2 Enter requested values in the dialog box and click **Create**. For detailed information about the specific dialog box for the border to create, see below:
-

The Create Border Between Bodies dialog box

To use the create border between bodies command, the station must contain at least two objects.

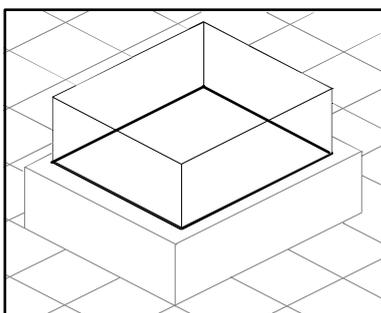

xx050044

First Body	Click in this box and then select the first body in the graphics window.
Second Body	Click in this box and then select the second body in the graphics window.

The Create Border Around Surface dialog box

To use the create border around surface command, the station must contain at least one object with a graphical representation.

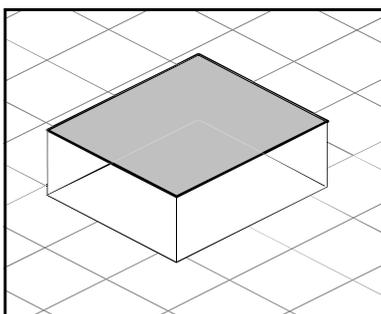

xx050045

Select Surface	Click in this box and then select a surface in the graphics window.
-----------------------	---

Continues on next page

The Create Border From Points dialog box

To use the create border from points command, the station must contain at least one object.

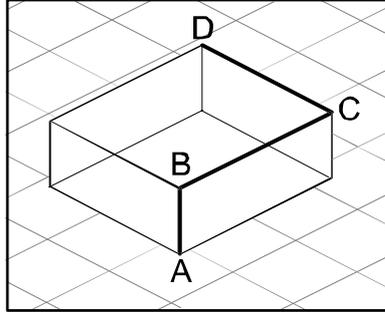

en050000

Selected Object	Click in this box and then select an object in the graphics window.
Point Coordinates	Specify the points that define the border here, one at a time, by either typing the values, or by clicking in one of these boxes, and then selecting the point in the graphics window to transfer its coordinates.
Add	Click this button to add a point and its coordinates to the list.
Modify	Click this button to modify an already defined point, after you have selected it in the list and entered new values.
List	The points that define the borders. To add more points, click Add New , click the desired point in the graphics window, and then click Add .

9 Modeling tab

9.11 Intersect

9.11 Intersect

The Intersect dialog box

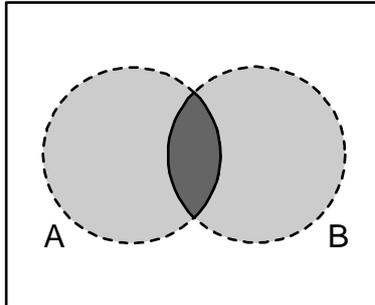

xx060009

Keep Original	Select this check box to keep the original bodies when creating the new body.
Intersect... (A)	Select the body from which you want to make an intersection (A) by clicking it in the graphics window.
...and (B)	Select the body with which you want to make an intersection (B) by clicking it in the graphics window. A new body will be created based on the common area between the selected bodies A and B.

9.12 Subtract

The Subtract dialog box

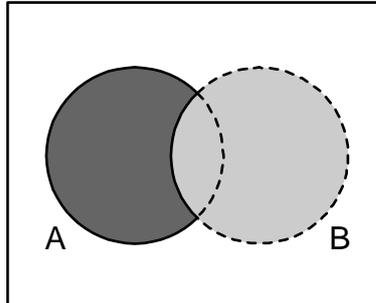

xx060010

Keep Original	Select this check box to keep the original bodies when creating the new body.
Subtract... (A)	Select the body from which you want to subtract (A) by clicking it in the graphics window.
...with (B)	Select the body you want to subtract (B) by clicking it in the graphics window. A new body will be created based on the area of body A subtracted with the common volume between body A and B.

9 Modeling tab

9.13 Union

9.13 Union

The Union dialog box

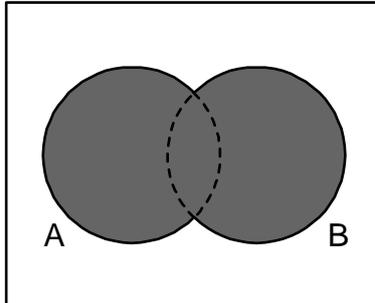

xx060011

Keep Original	Select this check box to keep the original bodies when creating the new body.
Union... (A)	Select the body that you want to unify (A) by clicking it in the graphics window.
...and (B)	Select the body that you want to unify (B) by clicking it in the graphics window. A new body will be created based on the areas of the two selected bodies A and B.

9.14 Extrude Surface or Curve

Extruding a surface or curve

- 1 From the selection level toolbar, select **Surface** or **Curve**, as appropriate.
- 2 In the graphics window, select the surface or curve you wish to extrude. Click **Extrude Surface** or **Extrude Curve**, as appropriate. The **Extrude Surface or Curve** dialog box opens below the **Layout** browser.
- 3 For extrusion along a vector, fill in the values.
For extrusion along a curve, select the **Extrude Along Curve** option. Click the **Curve** box, and select the curve in the **Graphics** window.
- 4 If you wish the form to appear as a surface model, clear the **Make Solid** check box.
- 5 Click **Create**.

The Extrude Surface or Curve dialog box

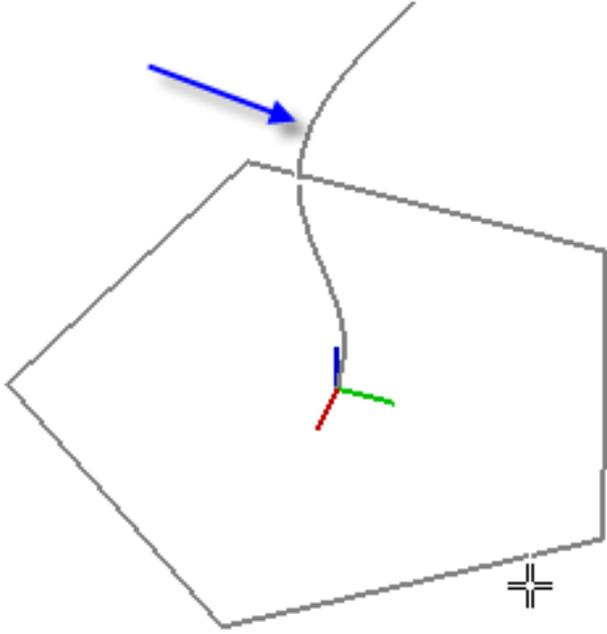
Surface or Curve	Denotes the surface or curve to be extruded. To select the surface or curve, first click in the box, then select the surface or curve in the graphics window.
Extrude Along Vector	Enables extrusion along a specified vector.
From Point	The start point of the vector.
To Point	The end point of the vector.
Extrude Along Curve	Enables extrusion along a specified curve.
Curve	Denotes the curve used as a sweep path.  xx0600003076 To select the curve, first click the box, then the curve in the graphics window.

Continues on next page

9 Modeling tab

9.14 Extrude Surface or Curve

Continued

Make Solid	Select this check box to convert the extruded form into a solid.
-------------------	--

9.15 Line from Normal

Creating a line from normal

- 1 Click **Surface Selection**.
- 2 Click **Line to Normal** to bring up a dialog box.
- 3 Click on a face to select it in the **Select Face** box.
- 4 In the **Length** box, specify a length for the line.
- 5 Optionally, select the **Invert Normal** check box to invert the direction of the line.
- 6 Click **Create**.

9.16 The Measure Group



Tip

Make sure to select the appropriate snap mode and selection levels before making your measurements.

Measuring distances or angles

- 1 Click the type of measurement you want to use:

To measure the	Select
distance between two points you select in the graphics window.	Point to point
angle defined by three points you select in the graphics window. The first point to select is the converging point, thereafter you shall select one point on each line.	Angle
diameter, with the circle defined by three points you select from the graphics window.	Diameter
closest distance between two objects you select in the graphics window.	Minimum distance

The mouse pointer will turn into a ruler when you have activated any of the measurement functions.

- 2 In the graphics window, select the points or objects to measure between. Information about the measuring points is displayed in the **Output** window. The results will be displayed in the **Measurements** tab in the **Output** window when all points have been selected.
- 3 Optionally, repeat step 3 for making a new measurement of the same type.



Tip

You can also activate and deactivate the measurement functions from the measurement toolbar.

9.17 Create Mechanism

Create a new mechanism

- 1 Click **Create Mechanism**.
The Mechanism Modeler opens in create mode.
- 2 In the **Mechanism Model Name** box, enter a mechanism name.
- 3 From the **Mechanism Type** list, select a mechanism type.
- 4 In the tree structure, right-click **Links**, and then click **Add Link** to bring up the **Create Link** dialog box.
A suggested name appears in the **Link Name** box.
- 5 In the **Selected Part** list, select a part (which will be highlighted in the graphics window) and click the arrow button to add the part to the **Parts** list box.
The **Selected Part** list then automatically selects the next part, if any more are available. Add these, as required.

**Note**

Parts that are part of a library or mechanism cannot be selected.

- 6 Select a part in the **Parts** list box, enter any values in the **Selected Parts** group boxes, and then click **Apply to Part**.
Repeat for each part, as required.
- 7 Click **OK**.
- 8 In the tree structure, right-click **Joints**, and then click **Add Joint** to bring up the **Create Joint** dialog box.
A suggested name appears in the **Joint Name** box.
- 9 Complete the **Create Joint** dialog box, and then click **OK**.
- 10 In the tree structure, right-click **Frame/Tool Data**, and then click **Add Frame/Tool** to bring up the **Create Frame/Tool** dialog box.
A suggested name appears in the **Frame/Tool Data** name box.
- 11 Complete the **Create Frame/Tool** dialog box, and then click **OK**.
The validity criteria for the **Frame/Tool** node are as follows:
- 12 In the tree structure, right-click **Calibration**, and then click **Add Calibration** to bring up the **Create Calibration** dialog box.
- 13 Complete the **Create Calibration** dialog box, and then click **OK**.
- 14 In the tree structure, right-click **Dependency**, and then click **Add Dependency** to bring up the **Create Dependency** dialog box.
- 15 Complete the **Create Dependency** dialog box, and then click **OK**.
- 16 If all nodes are valid, compile the mechanism, see [Compiling a mechanism on page 340](#).

Create Conveyor

- 1 Click **Create Conveyor**. The **Create Conveyor** browser opens.

Continues on next page

9 Modeling tab

9.17 Create Mechanism

Continued

- 2 From the **Conveyor Geometry** list, select a geometry.
- 3 In the **Reference Frame**, enter the base frame values (**Position** and **Orientation**) relative to the World/local origin of the selected graphic component.

The **Reference Frame** defines the position where objects appear on the conveyor.

- 4 From the **Type** list, select the type of conveyor.



Note

Only linear conveyors are supported.

- 5 In the **Conveyor length** box, enter the length of the conveyor. The **Create Mechanism** gets enabled.
- 6 Click **Create** to create the conveyor.
- 7 Build a new system using [Building a new system on page 185](#).
In the **System Options** pane, scroll down to **Motion Coordination** and then select **606-1 Conveyor Tracking** under **Conveyor Control Options**.
- 8 Create a new station using this new system.

Create connection between virtual controller and conveyor

- 1 In the **Modeling** tab, click **Create Connection**.
- 2 In the **Create Connection** tab, select the conveyor library in the **Conveyor** list and then select the mechanical unit of the system.
- 3 Set a suitable offset (base frame of the conveyor). This offset defines the location of the base frame of the conveyor mechanical unit in relation to the Conveyor reference frame.
- 4 Under the **Connection Window**, set appropriate values for **Minimum** and **Maximum distances**, and **Start Window Width**.
- 5 Under **Base Frames**, select the following options:
 - Select **Station Values** to update the virtual controller with the station layout values.
 - Select **Align Task Frame** to move the task frame to the connection (to align it with the base frame). The conveyor base frame will become zero.
 - Select **Use Controller Values** to update the station layout and the task frame to match the virtual controller values.
- 6 Click **Create**.

Compiling a mechanism

When compiling, a new mechanism, created in the create mode of the Mechanism Modeler, is added to the station with the default name "Mechanism_" followed by an index number.

Continues on next page

When compiling, an existing editable mechanism, modified in the modify mode of the Mechanism Modeler, is saved without any poses, joint mapping or transition times.

To compile a mechanism, follow these steps:

- 1 To compile a new or edited mechanism, click **Compile Mechanism**.
The mechanism is inserted into the active station. The link parts are cloned with new names, but the corresponding links will update their part references. When the Mechanism modeler is closed, these cloned parts will be removed.
- 2 The Mechanism Modeler now switches to modify mode. To complete the mechanism, see below.

Completing or modifying a mechanism

To complete the modeling of a mechanism, follow these steps:

- 1 If the values in the **Joint Mapping** group are correct, click **Set**.
- 2 Configure the Poses grid. To add a pose, click **Add** and then complete the **Create Pose** dialog box. Click **Apply**, followed by **OK**.
 - To add a pose, click **Add** and then complete the **Create Pose** dialog box. Click **Apply**, followed by **OK**.
 - To edit a pose, select it in the grid, click **Edit**, and then complete the **Modify Pose** dialog box. Click **OK**.
 - To remove a pose, select it in the grid and then click **Remove**.
- 3 Click **Edit Transition Times** to edit transition times.
- 4 Click **Close**.

The Create Mechanism dialog box

Mechanism Model Name	Specifies the model name of the mechanism.
Mechanism Type	Specifies the mechanism type.
Tree structure	The components of the mechanism in a tree structure. The tree structure will not be visible unless the mechanism is editable. Each node (link, joint, frame, calibration and dependency) can be edited in its own dialog box, see below.
Compile Mechanism	Click this button to compile the mechanism. This button will not be visible unless the mechanism is editable and the mechanism model name is valid.

The Create Conveyor Mechanism dialog box

Reference	Specifies the reference coordinates, World , Local and UCS . Based on the selection, the position and orientation values change.
Conveyor Geometry	Specifies the part to be selected for the conveyor.
Type	Specifies the type of conveyor.
Conveyor Length	Specifies the length of the conveyor.
Create	Click this button to compile the mechanism. This button will not be visible unless the mechanism is editable and the mechanism model name is valid.

Continues on next page

9 Modeling tab

9.17 Create Mechanism

Continued

The Create/Modify Link dialog box

A link is a moving component of a mechanism. Selecting a link node will highlight it in the graphics window.

Link Name	Specifies the name of the link.
Selected Part	Specifies the parts to add to the Part list box.
Set as BaseLink	The BaseLink is where the kinematical chain begins. This must be the parent of the first joint. A mechanism may have only one BaseLink.
 xx060000	Adds a selected part to the Part list box.
Remove Part	Click this button to remove a selected part from the Part list box.
Selected Part	This group manipulates the transform of the selected part.
Part Position	Specify the position of the part.
Part Orientation	Specify the orientation of the part.
Apply to Part	Click this button to apply the settings to the part.

The Create/Modify Joint dialog box

A joint is the axis where two links move in relation to each other. The available options are Rotational, Prismatic and [Four Bar joint on page 343](#). Selecting a joint node will display a yellow-green line in the graphics window.

Joint Name	Specifies the name of the joint.
Joint Type.	Specifies the joint type. The default option is Rotational . Changing the Joint Type clears the Joint Limits below.
Parent Link	Specifies the parent link, usually the first joint of the mechanism.
Child Link	Specifies the child link. To be valid, the parent and child links may not be identical to each other, and the pair must be unique.
Active	Select this check box to make the joint active. An active joint is one that a user can move, while an inactive joint is a slave to an active joint.
Joint Axis	This group specifies the axis around or along which the child moves.
First Position	Specify the start point of the axis vector.
Second Position	Specify the end point of the axis vector.
Jog Axis	Demonstrates how the child link moves along its axis.

Continues on next page

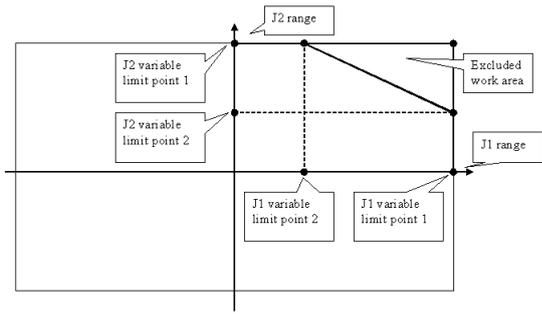
Limit Type	Specifies the limits in each direction to which a joint may move. The options are Constant , Variable and No .
Joint Limits	This group is visible in Constant or Variable mode.
Min Limit	Specifies the minimum joint limit.
Max Limit	Specifies the maximum joint limit.
Joint Limits	This group is visible in Constant or Variable mode.
Variable Limits	<p>In Variable mode, variable limit points may be added as an advanced way of delimiting the area of movement.</p>  <p>xx060012</p>
 left-click	Adds a selected point to the Point list box.
Remove	Click this button to remove a selected point from the Point list box.

Four Bar joint

The Four Bar joint consists of several links/parts. This joint is of closed-loop type hence it cannot be modeled with the standard functionality of the Mechanism Modeler that otherwise supports open loop mechanisms only. The Four Bar joint is typically used for car motor hoods or trunk lids.

Limitations of Four Bar joint

- Available only for Device type joints.
- The joint preview does not support Four Bar joints.



Note

The mechanism must be compiled before testing Four Bar joint. If you must change the mechanism, use the **Modify Mechanism** command to re-open the Mechanism Modeler of the corresponding mechanism.

The Modify Frame/Tool Data dialog box

A frame/tool data node determines the link and location of a frame.

Frame/Tool Data name	Specifies the name of the frame or tool data.
Belongs to Link	Specifies the link to which the frame or tool belongs.
Position	Specify the position of the transform.

Continues on next page

9 Modeling tab

9.17 Create Mechanism

Continued

Orientation	Specify the orientation of the transform.
Select values from target/Frame	Select this box to select the values from a target or frame, which is selected in the box beneath the check box.
Tool Data	This group is visible if the mechanism is a tool.
Mass	Specifies the mass of the tool.
Center of Gravity	Specify the center of gravity of the tool.
Moment of Inertia lx, ly, lz	Specify the moment of inertia of the tool.

The Create Calibration dialog box

A calibration contains transforms for calibrating the joints. Two calibrations cannot share the same joint.

Calibration belongs to Joint	Specifies the joint to be calibrated.
Position	Specify the position of the transform.
Orientation	Specify the orientation of the transform.

The Create Dependency dialog box

A dependency is a relationship between two joints, by either a factor or a complex formula.

Joint	Specifies the joint whose motion will be controlled by other joints.
Use LeadJoint and factor	Select this option to specify a lead joint and factor.
LeadJoint	Specifies the lead joint.
Factor	This list holds a double which denotes the extent to which the lead joint will control the main joint.
Use Formula	Select this option to enter a formula in the box.

The Modify Mechanism dialog box

The **Modify Mechanism** dialog box contains the objects found in the **Create mechanism** dialog box, as well as the following:

Joint Mapping	These boxes handle the joint mapping of the mechanism. When editing, the mechanism must be disconnected from its library. The values must be integers from 1 – 6 in ascending order.
Set	Click this button to set the joint mapping.
Poses	Displays the poses and their joint values. Selecting a pose will move the mechanism to it in the graphics window.
Add	Click this button to bring up the Create Pose dialog box for adding a pose.
Edit	Click this button to bring up the Modify Pose dialog box for editing a selected pose. A SyncPose cannot be edited unless the mechanism is disconnected from its library.
Remove	Click this button to remove the selected pose. A single SyncPose cannot be removed.

Continues on next page

Set Transition Times	Click this button to edit the transition times.
-----------------------------	---

The Create/Modify Pose dialog box

Pose Name	Specifies the name of the pose. If the pose is a SyncPose, this box is not editable. The names "HomePosition" and "SyncPosition" are disallowed.
Home Pose	Select this box to specify the home pose of the mechanism. If selected, the non-editable pose name will be "HomePose".
Launch Joint Jog Tool	Click this button to bring up the joint jog tool.
Use Current	Click this button to set the current joint values in the Joint Values group.
Reset Values	Click this button to reset the joint values in the Joint Values group to what they were when the dialog box was opened.
Joint Values	Specify the joint values of the pose.

The Set Transition Times dialog box

The **Set Transition Times** dialog box is designed like a distance table in a road atlas. The default values are zero.

From Pose	Specifies the start of the transition for the named pose.
To Pose	Specifies the end of the transition for the named pose.

9.18 Create Tool

Creating a tool

You can create a robot hold tool by using the **Create Tool Wizard**. The wizard allows you to easily create a tool from an existing part or by using a dummy part to represent a tool. To create a tool complete with tooldata, follow these steps:

- 1 Click **Create Tool**.
- 2 In the **Tool Name** box, enter a tool name and choose one of the following options:

Option	Action
Use Existing	Select one of the existing parts from the list. The selected part will represent the tool graphics. The selected part must be a single part. Parts with attachments cannot be selected.
Use Dummy	A cone will be created to represent the tool.

- 3 Continue entering the **Mass** of the tool, the **Center of Gravity** and the **Moment of Inertia Ix, Iy, Iz**, if these values are known.



Note

If you do not know the correct values, the tool can still be used for programming motions, but this data must be corrected before running the program on real robots or measuring cycle times.



Tip

If the tool is built from materials with a similar density, you can find the center of gravity by clicking the tool model using the **Center of gravity** snap mode.

- 4 Click **Next**.
- 5 In the **TCP Name** box, enter a name for the Tool Center Point (TCP).



Note

The default name is the same as the name of the tool. If creating several TCPs for one tool, each TCP must have a unique name.

- 6 Enter the position of the TCP relative to the world coordinate system, which represents the tool mounting point, by any of the methods below:

Method	Description
Read values from existing target or frame	Click in the Values from Target/Frame box, then select the frame either in the graphics window or the Paths&Targets browser.

Continues on next page

Method	Description
Enter position and orientation manually.	In the Position and Orientation boxes, type the values. If Use Dummy Part is selected, the position value can not be 0,0,0. At least one coordinate has to be > 0 in order for a cone to be created.

- 7 Click the arrow right button to transfer the values to the **TCP(s):** box.
If the tool shall have several TCPs, repeat steps 5 to 7 for each TCP.
- 8 Click **Done**.
The tool is created and appears in the **Layout** browser and in the graphics window.

Creating tooldata for an existing geometry

Ensure to select the robot in which tooldata is created. To create tooldata for an existing geometry, follow these steps:

- 1 Click **Create Tool** and select **Use Existing** and the imported tool from the list.
- 2 Enter the requested data in the boxes in the **Create Tool Wizard**.
- 3 Attach the tool by dragging it to the robot.

What to do next

To make the tool ready to use, do one of the following:

- To make the robot hold the tool, attach the tool to the robot.
- In the graphics window, check the position and orientation of the TCP. If it is incorrect, modify the values in the tool frame part of the tooldata.
- To simplify future usage of the created tool, save it as a library. On the **File** menu, click **Save As Library**. Browse to the folder where you want to store the tool component, enter a name for the tool component and click **Save**.

9 Modeling tab

9.19 Physics Tools

9.19 Physics Tools

Overview

Use the Physics feature to include physics simulation together with the traditional robot simulation/programming tools. When you apply physics behavior to various RobotStudio objects like, joints, cable, parts and so on, they will follow the rules of physics during simulation.



Note

Cable simulation works only for the 64 bit version of RobotStudio.

Creating a cable

- 1 In the **Modelling** tab, in the **Create** group, click **Cable** to create a cable, the **Create Cable** pane opens, set cable properties like length, radius, material and so on here.
You can also create a cable from the **Physics** contextual tab.
- 2 Click in the station/robot to add the start and end points of the cable .
- 3 Select a point on the cable, and drag it to add control point. You can also set the control point in the **Create Cable** pane. The control point can be any **Free Point** or an **Attached Point**. You can attach the cable to any objects using the **Attached to** list box in the **Create Cable** pane.
- 4 Click **Create**, the new cable gets displayed in the **Layout** browser.

Setting the properties of materials

Select one of the following options to set/edit the material of cable.

- In the **Physics** contextual tab, in **Rigid Bodies** group, click **Material**. The **Physics Material** pane opens. You can select your material either from the standard material list or can use custom material. Click the **Edit Materials** option to edit material properties.
- In the **Layout** browser, right-click a part and then click **Physics\Material\Material Properties** to open the **Physics Material** pane. You can select your material either from the standard material list or can use custom material. Click the **Edit Materials** option to edit material properties.

Modifying length of a cable

- 1 In the **Layout** browser, right-click cable, then click **Modify Cable**. The **Modify Cable** pane opens.
- 2 Edit the required parameter and click **Apply**.

Click options **Shorter** or **Longer** to stretch or skew the cable.

Continues on next page

Applying Behavior to objects

Use the behavior feature to set various motion related characteristic to a RobotStudio object. A physics object follows the rules of physics during simulation. In the **Layout** browser, right-click a part and then select **Physics** to set various behavior options. The following settings are possible.

- **Inactive:** This object will not interact with other objects during simulation.
- **Fixed:** The position of the object remains fixed during simulation.
- **Kinematic:** During simulation, RobotStudio controls the motion of the object.
- **Dynamic:** During simulation the object follows rules of physics while in motion.

Similarly any joint created using the **Physics Joint** options will follow rules of physics. These options are **Rotational joint**, **Prismatic joint**, **Ball joint** and **Lock joint**.

This page is intentionally left blank

10 Simulation tab

10.1 Overview

The Simulation tab

The Simulation tab contains the controls for setting up, configuring, controlling, monitoring and recording simulations.

10.2 Create Collision Set

Overview

A collision set contains two groups, *Objects A* and *Objects B*, in which you place the objects to detect any collisions between them. When any object in *Objects A* collides with any object in *Objects B*, the collision is displayed in the graphical view and logged in the output window. You can have several collision sets in the station, but each collision set can only contain two groups.

Creating a collision set

- 1 Click **Create Collision Set** to create a collision set in the **Layout** browser.
- 2 Expand the collision set and then drag one of the objects to the **ObjectsA** node to check for collisions.

If you have several objects you want to check for collisions with objects in the **ObjectsB** node, for example, the tool and the robot, drag all of them to the **ObjectsA** node.

- 3 Drag the objects to the **ObjectsB** node to check for collisions.

If you have several objects you want to check for collisions with objects in the **ObjectsA** node, for example, the work piece and the fixture, drag all of them to the **ObjectsB** node.



Tip

Selecting a collision set or one of its groups (*Objects A* or *Objects B*) highlights the corresponding objects in the graphical window and the browser. Use this feature to quickly check what objects have been added to a collision set or to one of its groups.

10.3 Simulation Setup

Overview

The Simulation Setup dialog box is used to perform the following two main tasks.

- Setting up the sequence and entry point in the robot program
- Creating simulation scenarios for different simulated objects

Prerequisites

To set up a simulation, the following conditions must be met:

- At least one path must have been created in the station.
- The paths to be simulated must have been synchronized to the virtual controller.

Setup simulation pane

From this pane, you can perform the combined task of configuring the program sequence and program execution such as entry point, and running the execution mode.

You can create simulation scenarios containing different simulated objects and connect each scenario with a predefined state to ensure that the correct state is applied to all project objects before running the scenario. If you want to simulate a specific part or segment of the cell where not all simulated objects in the cell are included, you can set up a new scenario and add only the objects needed for simulation.

The Setup simulation pane consists of the following:

Option	Description
Active Simulation scenario	Lists all active station scenarios. <ul style="list-style-type: none"> • Add: Click to add a new scenario. • Remove: Click to delete the selected scenario. • Rename: Click to rename the selected scenario.
Initial state	Initial state of the simulation.
Manage states	Opens the Station Logic pane.
Simulated objects	Displays all objects that can be part of a simulation. Objects that utilize simulation time can be part of a simulation. For example, Virtual Controllers and Smart Components. When you create a new scenario, all objects are selected by default.
Virtual time mode	<ul style="list-style-type: none"> • Time slice: This option makes RobotStudio always use the time slice mode. • Free run: This option makes RobotStudio always use the free run mode.

Setting up a simulation

- 1 Click **Simulation Setup** to bring up the **Setup Simulation** pane.
- 2 Select the tasks to be active during simulation in the **Select Active Tasks** box.
- 3 Select the run mode as either **Continuous** or **Single Cycle**.
- 4 From the **Simulated Objects** list select the task.

Continues on next page

10 Simulation tab

10.3 Simulation Setup

Continued

- 5 Select the entry point from the **Entry point** list.
- 6 Click **Edit** to open the RAPID program where the user can edit the procedure.

Creating simulation scenarios

- 1 Click **Simulation Setup** to bring up the **Setup Simulation** pane.
- 2 Under **Active Simulation Scenario** ,
 - Click **Add** to create a new scenario in the **Simulated objects** box.
 - Click **Remove** to delete the selected scenario from the **Simulated objects** box.
- 3 Select a saved state for the scenario from the **Initial state** list.

10.4 Event Manager

Creating an event

- 1 Click **Event Manager**.
- 2 Click **Add** to open the New Event Wizard.
- 3 Complete the New Event wizard to create the event.

Event manager main parts

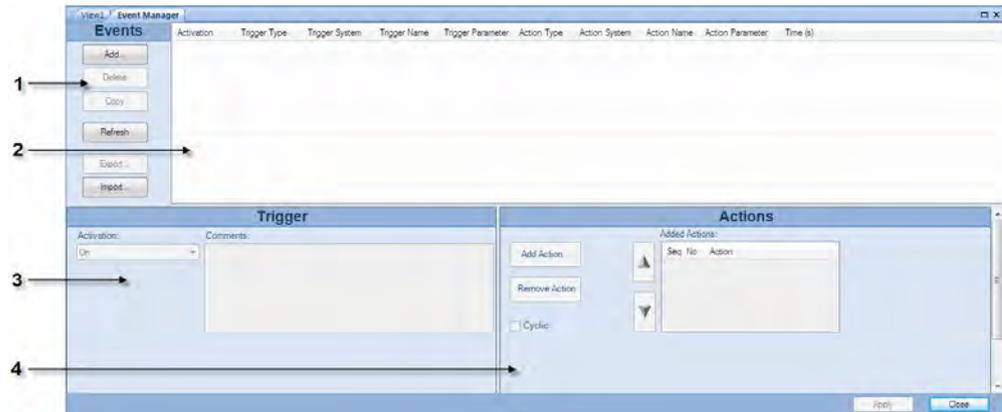

eventman

Part	Description
1	The Task pane. Here you create new events, or copy or delete existing events selected in the Event grid.
2	The Event grid. Displays all events in the station. Here you select events to edit, copy or delete.
3	The Trigger editor. Here you edit the properties of the events trigger. The upper part of the trigger editor is the same for all triggers, and the lower part adapts to the selected trigger type.
4	The Action editor. Here you edit the properties of the events action. The upper part of the action editor is the same for all actions, and the lower part adapts to the selected action type.

The task pane parts

Part	Description
Add	Starts the Create New Event Wizard .
Delete	Deletes the event selected in the Event grid.
Copy	Copies the event selected in the Event grid.
Refresh	Refreshes the Event manager.
Export	
Import	

Continues on next page

10 Simulation tab

10.4 Event Manager

Continued

The event grid columns

In the event grid, each row is an event and the columns in the grid display their properties.:

Column	Description
Activation	Displays whether the event is active or not. <ul style="list-style-type: none">• On: The action is always carried out when the trigger event occurs.• Off: The action is not carried out when the trigger event occurs.• Simulation: The action is only carried out if the trigger event occurs when running a simulation.
Trigger Type	Displays the type of condition that triggers the action. <ul style="list-style-type: none">• I/O signals changed: Changes a digital I/O signal.• I/O Connection: Simulates the behavior of a Programmable Logic Controller (PLC).• Collision: Starts or ends a collision or near-miss between objects in a collision set.• Simulation time: Sets the activation time.  Note <p>The Simulation time button is enabled once the activation is set to Simulation.</p> <p>The trigger type cannot be changed in the trigger editor. If you want another trigger type than the current one, create a completely new event.</p>
Trigger System	When the trigger type is <i>I/O Signal Trigger</i> , this column displays to which system the signal used as trigger belongs. A dash (-) signifies a virtual signal.
Trigger Name	The name of the signal or collision set used as trigger.
Trigger Parameter	Displays the condition of the event under which triggering occurs. <ul style="list-style-type: none">• 0: The I/O signal used as trigger switches to false.• 1: The I/O signal used as trigger switches to true.• Started: A collision starts within the collision set used as trigger.• Ended: A collision ends within the collision set used as trigger.• Near miss started: A near-miss starts within the collision set used as trigger.• Near miss ended: A near-miss ends within the collision set used as trigger.

Continues on next page

Column	Description
Action Type	<p>Displays the action type that occurs in conjunction with the trigger</p> <ul style="list-style-type: none"> • I/O Signal Action: Changes the value of a digital input or output signal. • Attach Object: Attaches an object to another. • Detach Object: Detaches an object from another. • Turn On/Off Simulation Monitor: Toggles the simulation monitor of a specific mechanism. • Turn On/Off Timer: Toggles the process timer. • Move Mechanism to Pose: Moves the selected mechanism to a predefined pose and thereafter sends a station signal. Activates or deactivates the process timer. • Move Graphical Object: Moves a graphical object to a new position and orientation. • Show/Hide Graphical Object: Shows or hides the graphical object. • Do Nothing: No action occurs. • Multiple: The event triggers multiple actions, either all at once or one at a time, each time the trigger is activated. Each action can be viewed in the action editor.
Action System	<p>When the action type is <i>Change I/O</i>, this column displays the system to which the signal to change belongs. A dash (-) signifies a virtual signal.</p>
Action Name	<p>Displays the name of the signal to change, when the action type is <i>Change I/O</i>.</p>
Action Parameter	<p>Displays the condition after the action has occurred.</p> <ul style="list-style-type: none"> • 0: The I/O signal will be set to false. • 1: The I/O signal will be set to true. • On: Turns the process timer on. • Off: Turns the process timer off. • Object1 -> Object2: Displays the object to which another will be attached when the action type is Attach object. • Object1 <- Object2: Displays the object from which another will be detached when the action type is Detach object. • Ended: A collision ends within the collision set used as trigger. • Near miss started: A near-miss starts within the collision set used as trigger. • Near miss ended: A near-miss ends within the collision set used as trigger. • Multiple: Signifies multiple actions.
Time	<p>Displays the time when the event trigger was executed.</p>

Continues on next page

10 Simulation tab

10.4 Event Manager

Continued

The trigger editor parts

In the trigger editor you set the properties of the trigger. The upper part of the editor is common for all types of triggers, and the lower part adapts to the trigger type at hand.

Parts common to triggers

Part	Description
Activation	Sets whether the event is active or not. <ul style="list-style-type: none">• On: The action is always carried out when the trigger event occurs.• Off: The action is not carried out when the trigger event occurs.• Simulation = The action is only carried out if the trigger event occurs when running a simulation.
Comments	Text box for comments and notes about the event.

Parts specific to I/O signal triggers

Part	Description
Active Controller	Select the system to which the I/O to use as a trigger belongs.
Signals	Displays all signals that can be used as triggers.
Trigger Condition	For digital signals, sets whether the event shall trigger when the signals are set as true or false. For analog signals, which are only available for station signals, the event shall trigger under any of the following conditions: Greater than, Greater/Equal, Less than, Less/Equal, Equal to, Not equal to.

Parts specific to I/O connection triggers

Part	Description
Add	Opens a dialog box for adding an activator signal to the Activator Signals pane.
Remove	Removes a selected activator signal.
Add >	Opens a dialog box for adding an operator symbol to the Connections pane.
Remove	Removes a selected operator symbol.
Delay (s)	Specifies the delay in seconds.

Parts specific to Collision triggers

Part	Description
Collision Type	Set the kind of collision to use as trigger. <ul style="list-style-type: none">• Started: Triggers when a collision starts.• Ended: Triggers when a collision ends.• Near miss started: Triggers when a near-miss starts.• Near miss ended: Triggers when a near-miss ends.
Collision set	Select the collision set to use as trigger.

Continues on next page

The action editor parts

In the action editor you set the properties of the actions for the event. The upper part of the editor is common to all types of actions, and the lower part adjusts to the selected action.

Parts common to all actions

Part	Description
Add Action	Adds a new action that occurs when the triggering condition fulfills. You can add several different actions that either are performed at once or one at a time each time the event triggers. The following types of actions are available: <ul style="list-style-type: none"> • Change I/O: Changes the value of a digital input or output signal. • Attach object: Attaches an object to another. • Detach object: Detaches an object from another. • Turn On/Off Timer: Activates or deactivates the process timer. • Do Nothing: No action occurs (might be useful for manipulating sequences of actions).
Remove Action	Removes the action selected in the Added Actions list.
Cyclic	When selected, the actions are performed one at a time each time the trigger occurs. When all actions in the list have been performed, the event will restart with the first action in the list. When cleared, all actions are performed at once every time the trigger occurs.
Added Actions	Lists all actions of the event, in the order they will be executed.
Arrow	Rearranges the order in which the actions are executed.

Parts specific to I/O Actions

Part	Description
Active Controller	Displays all systems of the station. Select the system to which the I/O to change belongs.
Signals	Displays all signals that can be set.
Action	Sets whether the event shall set the signals to true or false. If the action is connected to an <i>I/O Connection</i> , this group will not be available.

Parts specific to Attach actions

Part	Description
Attach object	Select an object in the station to attach.
Attach to	Select the object in the station to attach to.
Update position / Keep position	<ul style="list-style-type: none"> • Update position = Moves the local origin of the attached object to the attachment point of the other object when making the attachment. For mechanisms, the attachment point is the TCP or the flange; for other objects, it is the local origin. • Keep position = Keeps the current position of the object to attach when making the attachment.
Flange index	If the mechanism you attach the object to has several flanges (attachments points), select the one to use.

Continues on next page

10 Simulation tab

10.4 Event Manager

Continued

Part	Description
Offset Position	Optionally, specify an offset between the objects when making the attachment
Offset Orientation	Optionally, specify an offset between the objects when making the attachment

Parts specific to Detach actions

Part	Description
Detach object	Select an object in the station to detach.
Detach from	Select the object in the station to detach from.

Parts specific to Turn On/Off Simulation Monitor actions

Part	Description
Mechanism	Selects the mechanism.
Turn Simulation Monitor On/Off	Sets whether the action shall start or stop the simulation monitor function.

Parts specific to Turn On/Off Timer actions

Part	Description
Turn On/Off Timer	Sets whether the action shall start or stop the process timer.

Parts specific to Move Mechanism to Pose actions

Part	Description
Mechanism	Selects the mechanism.
Pose	Selects between SyncPose and HomePose .
Station signal to set when Pose reached	Lists the station signals that are sent after the mechanism reaches its pose.
Add Digital	Click this button to add a digital signal to the grid.
Remove	Click this button to remove a digital signal from the grid.

Parts specific to Move Graphical Object actions

Part	Description
Graphical Object to Move	Select a graphical object in the station to move.
New Position	Sets the new position of the object.
New Orientation	Sets the new orientation of the object.

Parts specific to Show/Hide Graphical Object actions

Part	Description
Graphical Object	Select a graphical object in the station.
Show/Hide	Sets whether the object is shown or hidden.

10.5 Station Logic

Introduction to Station Logic

The Station Logic has some of the characteristics of a Smart Component. It can be used to work with these characteristics on the station level.

The Station Logic editor consists of the following tabs similar to that of a Smart Component editor:

- Compose
- Properties and Bindings
- Signals and Connections
- View

For more information on the characteristics of a Smart Component editor, see [Smart Component on page 284](#).

Opening Station Logic

You can launch Station Logic in any of the following two ways:

- In the **Simulation** tab, click **Reset** and select **Manage States**.
- In the **Layout** browser, right-click the station and select **Station Logic**.

Differences between Station Logic and Smart Component

The following table lists some of the differences while working with Station Logic and a Smart Component:

Smart Component	Station Logic
The Editor window consists of a text box displaying the description of the component that is used for modifying the text.	The Editor window do not have the description text box wherein the description can be modified.
The Compose tab has the following options: <ul style="list-style-type: none"> • Child components • Saved States • Assets 	The Compose tab has the following options: <ul style="list-style-type: none"> • Child components • Saved States
The Properties and Bindings tab has the following options: <ul style="list-style-type: none"> • Dynamic Properties • Property Bindings 	The Properties and Bindings tab has the following options: <ul style="list-style-type: none"> • Property Bindings
In the Signals and Connections tab, when working with Add or Edit I/O Connections, you do not have the option of selecting the VCs in the station from the the Source Object and Target Object list.	You can create connections to and from I/O signals in a VC. In the Signals and Connections tab, when working with Add or Edit I/O Connections, you have the option of selecting the VCs in the station from the the Source Object and Target Object list.

10.6 Activate Mechanical Units

To activate or deactivate mechanical units manually

- 1 Click **Activate Mechanical Units** to bring up a dialog box.
- 2 In the **Activate Mechanical Units** dialog box, select the check boxes for the mechanical units to set as active. When activating a mechanical unit that shares a common drive unit, the other mechanical unit sharing that drive unit will be deactivated automatically.

10.7 Simulation Control

Running a simulation

- 1 In the **Simulation Control** group,

Click...	to...
Play/Resume	start and resume the simulation. <ul style="list-style-type: none"> • The Pause button is enabled once you start the simulation • The Play button is changed to Resume once you pause the simulation. • Click Resume to resume the simulation.
Play and select Record to Viewer	start the simulation and to record it to a Station Viewer. The Save As dialog box appears where the simulation is saved.
Pause/Step	pause and step the simulation. <ul style="list-style-type: none"> • The Pause button is changed to Step once you start the simulation. • Click Step to run the simulation in steps. You can set the simulation timestep. See Options:Simulation:Clock on page 223 .
Reset	reset the simulation to its initial state. See Resetting simulation on page 363 .



Note

When running a simulation in time slice mode, all breakpoints set in the RAPID editor windows will be deactivated temporarily.



Note

During the simulation play, if a user does not want more objects to be added to the conveyor, in **Layout** browser, expand the conveyor node, then right-click the object source and clear the **Enabled** option.

Resetting simulation

- 1 In the **Simulation Control** group, click **Reset** to reset the simulation.
- 2 Click **Reset** and select **Save Current state** to store states of objects and VCs to be used in a simulation scenario. For more information, see [Save Current State on page 287](#).
- 3 Click **Reset** and select **Manage states** to launch Station Logic. For more information, see [Station Logic on page 361](#).

10 Simulation tab

10.8 I/O Simulator

10.8 I/O Simulator

Setting I/O signals using the I/O Simulator

- 1 Click **I/O Simulator**. This opens the I/O simulator.
- 2 If the station contains several systems, select the appropriate one in the **Select System** list.
- 3 In the **Filter** list and **I/O Range** list, make selections that display the signals to set. Depending on the filter used, you might also set a filter specification.
- 4 To change the value of a digital I/O signal, click it.
To change the value of an analog signal, type the new value in the value box.

The I/O Simulator window

With RobotStudio's I/O simulator window, you can view and manually set existing signals, groups and cross-connections during program execution, thus making it possible to simulate or manipulate the signals.

The I/O simulator window displays the signals for one system at a time, in groups of 16 signals. For handling large sets of signals, you can filter which signals to display and also create custom lists with favorite signals for quick access.

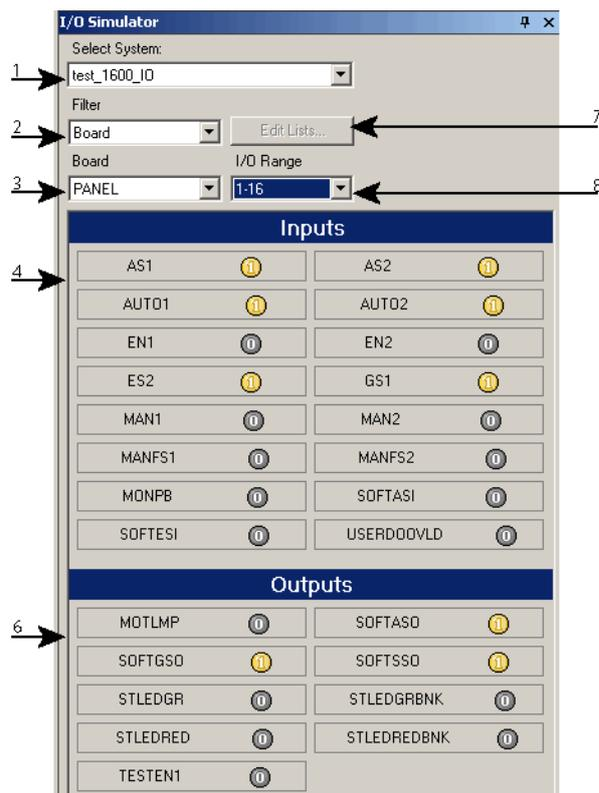

io_overv

Part	Description
1	Select System. Select the system whose signals you want to view.
2	Filter type. Select the type of filter to use.

Continues on next page

Part	Description
3	Filter Specification. Select the filter for limiting the signal display. For example, if Board is set as filter type, then you select the board whose signals you want to view.
4	Inputs. Displays all input signals that pass the applied filter. If more than 16 signals pass, only 16 signals at a time are displayed. Then use the I/O range list to select the signals to view.
5	Outputs Displays all output signals that pass the applied filter. If more than 16 signals pass, only 16 signals at a time are displayed. Then use the I/O range list to select the signals to view.
6	Edit Lists. Click this button to create or edit lists of favorite signals.
7	I/O Range. When more than 16 signals pass the filter, use this list to select the range of signals to display.

Types of signal filters

Filter	Description
Board	Displays all signals on a specific board. To select a board, use the Filter Specification list.
Group	Displays all signals that belong to a specific group. To select a group, use the Filter Specification list.
User List	Displays all signals in a favorite list. To select a list, use the Filter Specification list.
Digital Inputs	Displays all digital input signals of the system.
Digital Outputs	Displays all digital output signals of the system.
Analog Inputs	Displays all analog input signals of the system.
Analog Outputs	Displays all analog output signals of the system.

Signal icons

 value 1	Digital signal with value 1.
 value zero	Digital signal with value 0.
 cross connec	The cross in the upper right corner indicates that the signals are a cross-connection.
 inverted	The -1 in the upper right corner indicates that the signal is inverted.
 value box	Value box for groups or analog signals.

10 Simulation tab

10.9 Monitor

10.9 Monitor

The TCP Trace tab

Enable TCP Trace	Select this check box to activate tracing of the TCP path for the selected robot.
Follow moving Workobjects	Select this check box to activate tracing of moving workobject.
Clear trace at simulation start	Select this check box to remove the current trace when simulation starts.
Primary color	You can set the color of the trace here.
Color by signal	Select this check box to assign a particular color to the TCP path of the selected signal.
Use color scale	Select this button to define how the trace shall be colored. As the signal changes between the values defined in the From and To boxes, the color of the trace also varies according to the color scale.
Use secondary color	You can assign a color to the trace which gets displayed when the signal value meets the specified conditions.
Show events	Select this check box to view events along the trace.
Clear TCP traces	Click this button to remove the current trace from the graphics window.

The Alerts tab

Enable Simulation Alerts	Select this check box to activate simulation alerts for the selected robot.
Log Alerts to Output Window	Select this check box to see a warning message when a threshold value is exceeded. If TCP trace is not enabled, this is the only display of the alert.
TCP Speed	Specify the threshold value for TCP speed alerts.
TCP Acceleration	Specify the threshold value for TCP acceleration alerts.
Wrist Singularity	Specify how close joint five can be to zero rotation before alerting.
Joint Limits	Specify how close each joint can be to its limits before alerting.

10.10 Stopwatch

Stopwatch for measuring process time

The Stopwatch feature is used for measuring the time taken between two trigger points in a process, and also for the process as a whole. The two trigger points are called the Start Trigger and the End Trigger.

When a stopwatch is setup, the timer starts when the Start Trigger occurs, and stops when the End Trigger occurs.

Setting up a Stopwatch

- 1 On the **Simulation** tab, in the **Monitor** group, click **Stopwatch**.
The Stopwatch settings dialog appears.
- 2 Specify a **Name** for the stopwatch.
- 3 Select a **Start Trigger** and an **End Trigger** for the stopwatch.

The following parameters are listed for selection as triggers:

- Simulation Start
- Simulation Stop
- Target Changed

Additionally, specify the mechanical Unit and the target.

- I/O Value

Additionally, specify the source mechanical unit from where the signal comes, the type of I/O signal and the value of the signal.

- 4 Click **Add**.

10 Simulation tab

10.11.1 Signal Analyzer for both real and virtual controllers

10.11 Signal Analyzer

10.11.1 Signal Analyzer for both real and virtual controllers

The Signal Analyzer functionality helps in displaying and analyzing signals from a robot controller. Using the Signal Analyzer, you can optimize the robot program. The Signal Analyzer functionality is present for both virtual and real controllers. The version adapted for real controllers is called Signal Analyzer Online. The following section describes the Signal Analyzer functionality for virtual controllers, though it includes certain common features.

10.11.2 Signal Setup

Overview

This feature allows you to configure the signals to be saved for the next simulation. The signals are recorded from the controller information stream and are stored in the station.

Layout of Signal Setup

The Signal Setup window displays all the signals available for recording. It also displays the signals selected for recording.

The Signal Setup window has the following options:

- Select Signals view
- Current Setup view
- Refresh

Select Signals view

Displays all the available source signals. By default, the source tree is expanded. In the source tree, you can select the check-box and add the signal to the Current Setup view.

The signals are organized in a hierarchical tree structure. You can expand or collapse the nodes (except the signal nodes which are at the lowest level) either from the context menu or double-click the node.

Current Setup view

Displays all the selected signals.

To remove a signal, Right-click the signal and select **Delete**.

Refresh

The Signal Setup window, by default, will be updated automatically, if a signal is added or removed. However, in some cases, a manual refresh may be needed.

In the **Signal Setup** window, click **Refresh** to ensure all signals are displayed in the window.

Available signals

The following tables show the signals that are available for setting up. You can subscribe to a maximum of 12 signals simultaneously.

Category	Available signals
Controller Signals	Total Motor Power. See the description provided after this table.
	Total Power Consumption. See the description provided after this table.
EventLog	All domains
I/O System	All signals
Joint	J1-J6
	Near Limit. See the description provided after this table.

Continues on next page

10 Simulation tab

10.11.2 Signal Setup

Continued

Category	Available signals
Target	Fine Point
	Target Changed , Tool Changed, Workobject Changed
TCP	Maximum Linear Acceleration in World
	Orientation Q1-Q4 Current Workobject
	Orientation Speed in Current Workobject
	Pos X, Y, Z in Current Workobject
	Robot Configuration cf1, cf4, cf6, cfx
	Speed in Current Workobject
	Zone Entered, Zone Left
TCP	
Smart Components	All signals

Total Motor Power

The Total Motor Power signal shows the total instantaneous power for each joint. It may be positive or negative.

The instantaneous power for a specific joint is positive when it accelerates and negative when it decelerates. If one joint is accelerating at the same time as another joint is decelerating, then the negative energy from the decelerating joint is reused by the accelerating joint. If the sum of the instantaneous power of all joints is negative then the power surplus cannot be reused but it is burned off in the bleeder.

For a virtual robot the signal is based on a nominal robot during typical conditions, for a real robot the signal is based on the torque for that particular robot in the actual conditions. For a real robot the value of the motor power signal depends on various factors, for example, the temperature of the robot and the length of the cables.



Note

Total Motor Power signal represents the power consumed by the mechanical robot arm and not the power that is fed into the controller cabinet from the power network. The power used by the controller cabinet is excluded.

Total Motor Energy

The Total Motor Energy signal is the cumulative sum of the positive part of the Total Motor Power.

Continues on next page

Purpose of signals

The purpose of the Total Motor Power and Total Motor Energy signals is to provide an estimate of the power and energy used by the robots. For virtual robots, these signals can be used to identify peaks in the power usage to enable the robot programmer to adjust the robot program with the aim to reduce the power consumption. For real robots, the signals can be used to compare the power usage of different robot individuals running the same robot program, to see if any robot differs significantly from the others. Any such deviation may indicate that the robot needs maintenance.

Near Limit

Near Limit checks the distance to the closest limit for each joint. If any joint is less than 20 degrees from a limit, the Near Limit signal will show the current value. Otherwise, the value of the signal will be constant at 20 degrees. If more than one joint is below 20 degrees from a limit, then the one that is closest will be looked at.

Setting up the signals

Use this procedure to configure the signals to be saved for the next simulation:

- 1 Load a station with system. See [New tab on page 211](#) .
- 2 In the **Simulation** tab, click **Signal Analyzer** and select **Signal Setup**.
The Signal Setup window appears.
- 3 In the **Select Signals** view, select the signals to be configured and stored for simulation.
The selected signals are added in the Current Setup window.
- 4 In the **Current Setup** view, right-click **Station Database** and select **Enabled**.
This ensures that all selected signals will be recorded whenever a simulation is running.



Note

- Disabling the station database will stop the recording but stores the configuration and all completed recordings in the station.



Note

- You can analyze the recorded signals. See [Layout and usage on page 373](#).
- You can organize the saved signal data. See [History on page 376](#).
- Disable signal recording as soon as the analysis is completed to avoid the station file size to increase.

Continues on next page



Note

It is not possible to subscribe to signals connected to a unit of type LOCAL_GENERIC. Attempting to do so produces this error message in the Output window:

```
Failed to subscribe on signal:
```

10.11.3 Layout and usage

Layout of Signal Analyzer

The following figure shows the layout of the Signal Analyzer

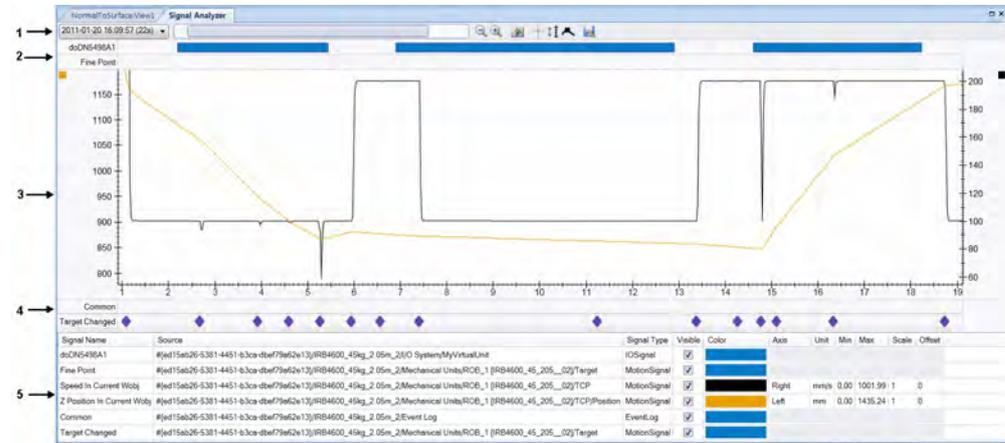

en110000034

1	Toolbar	Displays a toolbar with options to configure and to work with the Signal Analyzer.
2	Digital signal values	Displays a colored bar representing a segment where the signal is set.
3	Analog signal values	Displays analog and numeric signal values.
4	Events	Displays discrete events, such as EventLog messages.
5	Signals table	Displays information about all recorded signals for the current data session.

Toolbar

The toolbar displays the following options:

Option	Description
Drop-down list	For selecting the signal recording to be displayed. These signals are also available in Signal History. See History on page 376 .
Timer slider	For moving the time forward and backward.
Zoom in/out buttons	For zooming in / out the time axis.
Live data button	For enabling data to be shown live, that is, as recorded during a simulation.
Crosshair	For displaying the crosshairs following the mouse.
Auto scale button	For enabling / disabling vertical axis autoscaling.
Line marker button	For displaying the line markers for each sample in the analog / numeric graph.
Save button	For exporting the data to a file. The data can be saved in <i>Microsoft Excel 2007</i> format and <i>tab delimited text</i> format.

Continues on next page

10 Simulation tab

10.11.3 Layout and usage

Continued

Digital signal values

It displays one row per digital signal, showing the signal state over time. A solid colored bar indicates the signal is set (value=1), otherwise the signal is cleared (value=0). The signal name is displayed to the left.

Move the mouse over the colored bars to view additional information like the time stamps when the signal was set and reset.

Analog signal values

It displays a 2D line graph for each analog signal. It consists of the following:

- Left-side vertical axis
- Horizontal axis displaying time in seconds
- Plot area displaying the signal graphs
- Optional right-side vertical axis.

You can configure the individual signals to use the right-side vertical axis scale from the signals table at the bottom of the window. This axis is hidden by default.

The following actions can be performed in this segment:

- Scale the vertical axes: If you select the autoscale button in the toolbar, then the vertical axes will automatically scale to ensure that the line graphs are visible. You can modify the vertical scale using the mouse if the cursor is over the axis value area. This automatically deselects the autoscale button.
- Pan and Zoom time axis: If the cursor is over the central, main area of the plot, then you can scale, pan, and zoom the time axis using the mouse.

Events

It displays one row per selected event category. Each event is indicated with a diamond shaped icon. Click this icon to display a popup with more information about the event.

Signals table

Displays information about each recorded signal. This enables you to configure settings for each signal such as color, visibility, whether to use left or right vertical axis and so on.

Using the Signal Analyzer

Use this procedure to analyze the recorded signal data:

- 1 Set up the signals to be analyzed. See [Setting up the signals on page 371](#).
- 2 Record signal data by running a simulation. See [Setting up the signals on page 371](#).
- 3 In the **Simulation** tab, click **Signal Analyzer**.

Continues on next page

The Signal Analyzer window appears.



Note

- If the station does not contain any saved signal data, you will then have to setup the signals to analyze and record by running a simulation. See [Signal Setup on page 369](#).
- You can organize the saved signal data. See [History on page 376](#).
- The sample interval of the Signal Analyzer is 24 ms, hence signal changes within this interval will not be captured.

10.11.4 History

Overview

This feature displays and helps in organizing saved signal recordings of the current RobotStudio station.

Layout of Signal History

You can do the following from the *Signal History* window:

- Click the column header to sort the history in ascending or descending order.
 - Click the drop-down to group the history as *View By Today* or *View by Order*.
-

Organizing the Signal History

Use this procedure to organize the signal history:

- 1 Create a saved signal data in the station. See [Setting up the signals on page 371](#).

- 2 In the **Simulation** tab, click **Signal Analyzer** and select **History**.

The Signal History window with all the stored signal history elements are displayed.



Note

The signal history elements in the Signal History window is updated automatically whenever the signals are setup and the simulation is started / stopped.

- 3 In the **Signal History** window, right-click a history element and select:

- **Analyze:** To open the Signal Analyzer window.
- **Export:** To save selected history elements to a file.



Note

The maximum number of signals that can be exported to Excel is limited to 26.

- **Delete:** To remove the selected signal recording permanently.
- **Rename:** To rename the signal recording.



Note

Disable signal recording as soon as the analysis is completed to avoid the station file size to increase.

10.12 Record Movie

Prerequisites

For optimal results, first configure the options, see [Options:General:Screen Recorder on page 219](#).

Recording the screen

- 1 In the **Record Movie** group, click **Record application** to capture the entire application window, or **Record graphics** to capture just the graphics window.
- 2 When you are done, click **Stop Recording**. A dialog box appears in which you may choose to save the recording or discard it.
- 3 Click **View Recording** to playback the latest capture.

Recording the simulation

- 1 In the **Record Movie** group, click **Record Simulation** to record the next simulation to a video clip.
- 2 When you are done, click **Stop Recording**.
The simulation is saved in a default location which is displayed in the output window.
- 3 Click **View Recording** to playback the recording.
The recording of simulation starts when you click **Play** in the **Simulation** tab.



Note

Record Simulation gives better output quality than **Record application** or **Record graphics**.

10.13 Conveyor Tracking Mechanism

10.13.1 Conveyor Tracking

Overview

Conveyor tracking is the function where the robot follows a workobject mounted on a moving conveyor. This section describes *how to create a conveyor, add and remove objects to and from the conveyor, create targets during tracking, and simulate conveyor.*

RobotStudio does not support tracking of circular conveyors. Only linear conveyors are supported. For more information, see the *Application manual - Conveyor tracking.*

Conveyor tracking mechanism

This procedure describes the workflow for making a conveyor tracking system work in RobotStudio.

- 1 Create a conveyor mechanism. See [Create Conveyor on page 339](#).
- 2 Setup the conveyor. See [Adding objects to the conveyor on page 229](#).
For information on setting up a conveyor tracking station with two robots working on the same conveyor, see [Setting Conveyor tracking on page 83](#).
- 3 Jog the conveyor as well as the robot and teach some targets. See [Mechanism Joint Jog on page 510](#).
- 4 Simulate the conveyor. See [Conveyor Simulation on page 379](#).
- 5 Remove objects from conveyor. See [Removing objects from conveyor on page 230](#).

10.13.2 Conveyor Simulation

Running a conveyor simulation

- 1 Create Action Instructions. See [Action Instruction on page 260](#).

Create the following five action instructions along with Move instructions:

```
ConfL\Off,ActUnit CNV1,WaitWObj Workobject_1,
DropWObjWorkobject_1 and DeactUnit CNV1.
```

The following program is an example showing how the sequence of instructions appears:

```
ConfL\Off;
MoveJ p0, vmax , fine, tool1;
ActUnit CNV1;
WaitWObj wobjcnv1;
MoveL p10, v1000, z1, tool1\Wobj :=wobjcnv1;
MoveL p20, v1000, z1, tool1\Wobj :=wobjcnv1;
MoveL p30, v500, z20, tool1\Wobj :=wobjcnv1;
MoveL p40, v500, fine, tool1;
DropWObj wobjcnv1;
MoveL p0, v500, fine;
DeactUnit CNV1;
```



Note

If an error occurs while executing the program, the controller reaches Guard state. In this state, RobotStudio cannot execute the program during the next simulation. To recover from this state, open the **Control Panel** and switch to **Manual Mode** and then to **Auto Mode**.

For more information, see *Application manual - Conveyor tracking*.

- 2 Synchronize to VC. See [Synchronize to RAPID on page 447](#).
- 3 Set up the simulation. See [Simulation Setup on page 353](#).
- 4 In the **Layout browser**, right-click the conveyor mechanism and select **Motion**.
- 5 In the **Speed box**, set the speed during simulation.

Select the **Start** and **Stop** buttons to start and stop the conveyor during simulation.

- 6 Click **Apply**.
- 7 Click **Play** to run the simulation.

A RAPID program with Conveyor Tracking must be run with the **Play** button in the **Simulation tab**.

Continues on next page

10 Simulation tab

10.13.2 Conveyor Simulation

Continued



Note

The conveyor speed and direction can be changed while running the simulation. To jump the conveyor back to the start position, click **Reset**. This button remains enabled as long as the station has at least one conveyor.

11 Controller tab

11.1 Real and virtual controllers

Overview

The Controller tab contains the controls for managing the real controller and also the controls for synchronization, configuration and tasks assigned to the virtual controller.

RobotStudio allows you to work with an off-line controller, which is a virtual IRC5 controller running locally on your PC. This offline controller is also referred to as the virtual controller (VC). RobotStudio also allows you to work with the real physical IRC5 controller, which is simply referred to as the real controller.

The features on the Controller tab can be categorized as follows:

- Features for both virtual and real controllers
- Features for real controllers
- Features for virtual controllers

For more information on working with a real controller, see [Working online on page 155](#).

11 Controller tab

11.2.1 Add Controller

11.2 Features for both virtual and real controllers

11.2.1 Add Controller

Adding and connecting to a controller

You can connect to real or virtual controller using the **Add Controller** button.

To connect to a real controller, on the **Controller** tab click the arrow next to the **Add Controller** icon, and then click one of the following commands as per your requirement:

- **One Click Connect** - For connecting to the service port of the controller
- **Add Controller** - For adding available controllers to the network



Note

For connecting RobotStudio to a real controller over the Ethernet (LAN), the controller system must have the RobotWare option **PC-interface**. This option is not required when connecting through the service port.

To start and connect to a virtual controller, on the **Controller** tab click the arrow next to the **Add Controller** icon, and then click **Start Virtual Controller**.

One Click Connect

The One Click Connect feature allows connecting to a robot controller, that is connected to the service port, in a single step. You need to do the following before using this feature:

- Connect the computer to the controller service port.
- Ensure that the network settings on the PC is correct. DHCP should either be enabled or the IP address should have a specific value. For more information on network settings, see [Network settings on page 159](#).

On the **Controller** tab, click the arrow next to the **Add Controller** icon, and then click **One Click Connect**.

Add Controller

- 1 In the **Controller** tab, click **Add Controller** to bring up a dialog box in which all available controllers are listed.
 - 2 If the controller is not found in the list, type its IP address in the **IP Address** box, and then click **Refresh**.
 - 3 Select the controller in the list and click **OK**.
-

Add Remote Controller

- 1 In the **Controller** tab, click **Add Controller** to bring up a dialog box in which all available controllers are listed.
 - 2 If the controller is not found in the list, type its IP address in the **Remote Controller** box, and then click **Add**.
 - 3 Select the controller in the list and click **OK**.
-

Continues on next page

Start Virtual Controller

The **Start Virtual Controller** command allows you to start and stop a virtual controller, using a given system path and without needing a station.



Tip

You can use the **Start Virtual Controller** command when you require a virtual controller as emulator while developing PC SDK or RobotWare add-ins. You can also use this command when you need to use the Configuration editor or the RAPID editor without requiring a station.

Clicking **Start Virtual Controller** under **Add Controller** opens the *Start Virtual Controller* dialog box. In this dialog box, specify the following:

- 1 In the **System Pool** drop-down list specify the location and folder of your PC where the required virtual controller systems are stored.
To add a folder to this list, click **Add** and then browse to and select the folder to be added. To remove a folder from the list, click **Remove**.
- 2 The *Systems Found* table lists the virtual controller systems found in the selected system folder. Click a system to select it for starting.
- 3 Select the required check boxes:
 - **Reset system**, to start the VC with the current system and the default settings
 - **Local login**
 - **Handle Write Access automatically**



Note

A virtual controller system that has been modified using the **Modify System** function of the System Builder must be restarted with the **Reset System** option for the changes to take effect.

Low Bandwidth mode

The low bandwidth mode is useful when connecting RobotStudio to a controller over a network connection with limited bandwidth. It reduces controller communication to a fraction of the regular connection mode.



Note

RobotWare version installed in the controller and in the connecting PC must be same.

You can select the low bandwidth mode while connecting to the controller through the **Add controller** dialog.

Continues on next page

11 Controller tab

11.2.1 Add Controller

Continued

Limitations

In low bandwidth mode;

- the signal analyzer gets disabled.
- system requires manual refresh to update the I/O Viewer, RAPID Watch window, RAPID Program Pointer, Online Monitor and FlexPendant Viewer in RobotStudio with the current controller status, hence manual buttons are added to initiate the refresh.
- semantic check in the RAPID editor will be restricted.

11.2.2 Events

Overview

You can view events in the Event log. The severity of each event is indicated by its background color; blue for information, yellow for warning and red for an error which needs to be corrected to proceed.

On the **Controller** tab in the **Controller Tools** group, click **Events** to view the *Event* log.

Event log

You can perform the following operations on the *Event* log.

Available operations	Descriptions
View	Click any event to see a brief description about the event.
Automatic update	The Auto Update check box is selected by default, so that new events appear in the list as they occur. Clear the check box to disable automatic update. Selecting it again, fetches and displays the events missed while it was cleared.
Filter	You can filter the event log list based on the category of the event or based on any text in its displayed details. To filter the list based on any required text, specify it in the Text box. Use the Category drop-down list to filter based on the events categories. The event categories are: Common, Operational, System, Hardware, Program, Motion, I/O & Communication, User, Internal, Process, Configuration and RAPID.
Save	Click Save , to save the event records of the selected event categories to log files on the computer.
Log to file	Select the Log to file check box to enable all events currently in the Common Event Log to be saved to a log file. The log file will be updated with all new events as they occur.

11 Controller tab

11.2.3 Inputs/Outputs

11.2.3 Inputs/Outputs

Overview

You can view and set input and output signals in the *I/O System* window.

To open this window, on the **Controller** tab, in the **Controller Tools** group, click **Inputs/Outputs**.



Note

For details on local I/O and its features, refer *Application manual Local I/O*.

I/O System window

The following details of I/O signals are available in the *I/O System* window:

Column	Description														
Name	Shows the name of the signal, name is set by the device's configuration and cannot be changed from the I/O system.														
Type	Shows the type of signal using the abbreviations listed in the following table. <table border="1"><thead><tr><th>Abbreviation</th><th>Description</th></tr></thead><tbody><tr><td>DI</td><td>Digital input signal.</td></tr><tr><td>DO</td><td>Digital output signal.</td></tr><tr><td>AI</td><td>Analog input signal.</td></tr><tr><td>AO</td><td>Analog output signal.</td></tr><tr><td>GI</td><td>Group of signals, working as one input signal.</td></tr><tr><td>GO</td><td>Group of signals, working as one output signal.</td></tr></tbody></table> <p>The signal type is set by the device's configuration and cannot be changed from the I/O system.</p>	Abbreviation	Description	DI	Digital input signal.	DO	Digital output signal.	AI	Analog input signal.	AO	Analog output signal.	GI	Group of signals, working as one input signal.	GO	Group of signals, working as one output signal.
Abbreviation	Description														
DI	Digital input signal.														
DO	Digital output signal.														
AI	Analog input signal.														
AO	Analog output signal.														
GI	Group of signals, working as one input signal.														
GO	Group of signals, working as one output signal.														
Value	Shows the value of the signal, double-click the signal row to edit the value.														
Min Value	Shows the minimum value of a signal.														
Max Value	Shows the maximum value of a signal.														
Logical State	Shows the simulation status of a signal. When a signal is simulated, you can specify a value that overrides the actual signal value. You can change the logical state of a signal from the I/O system by turning the simulation ON/Off .														
Unit	Shows device to which the signal belongs. This is set by the device's configuration and cannot be changed from the I/O system. You can view this field in RobotWare 6.0 or before.														
Bus	Shows the industrial network to which the signal belongs. This is set by the industrial network configuration and cannot be changed from the I/O system. You can view this field in RobotWare 6.0 or before.														
Simulated	Shows whether the I/O device is simulated on the industrial network it is connected to.														

Continues on next page

Column	Description
Network	Shows the industrial network to which this I/O device is physically connected.
Device	Shows the logical representation of the real I/O device.
Device Mapping	Shows the bit(s) to which the I/O signal is mapped in the I/O memory map of the assigned I/O device.
Category	Shows a free-text categorization to an I/O signal.
Label	Shows the Signal Identification Label as defined in the I/O Configuration database.

It is possible to sort signals according to the signal properties. In the I/O System window, click the particular field to sort signals according to the field. If you press the SHIFT key and click multiple column headers then the columns will be sorted by the order clicked.

I/O System window view

Use the following parameters to set the view of the I/O system window.

- **Name and Label:** Use the free-text edit boxes above these columns. The resulting view will show signals that contain the entered text string in the respective field.
- **Simulated:** Select this check box to view simulated signals only
- **Unit, Bus, and Category:** Use the drop-down list boxes above each column to select the required option for the respective parameter. The resulting view will show only those signals that have the selected option.
- **Clear filter:** Click this button to reset the view, and show all signals again.

I/O Signal Data Editor

The I/O signal data editor is a table like editor used for editing signals. In this editor you can add, delete and sort signals. This table can be exported to Microsoft Excel for editing and for further importing back to RobotStudio.

Follow these steps to open an I/O signal data editor.

- 1 In the **RAPID** tab open a backup file.
- 2 In the **Files** browser, select the SYSPAR folder of the backup file and then right-click the *EIO.cfg* file.
- 3 In the context menu, click **I/O Signal Data Editor** option, the I/O signal data editor opens.

11 Controller tab

11.2.4 ScreenMaker

11.2.4 ScreenMaker

Overview

ScreenMaker is a tool in RobotStudio for creating customized FlexPendant user interfaces without the need to learn Visual Studio development environment and .NET programming.

For more information on ScreenMaker, see [ScreenMaker tab on page 541](#).

Prerequisites



Note

In RobotStudio 6.0, ScreenMaker is only available for the 32-bit edition and is therefore disabled in the 64-bit edition.

To use ScreenMaker, you need to fulfill the following requirements:

- RobotStudio with Premium license.
- The IRC5 controller(s) require the **FlexPendant Interface** option in RobotWare to run ScreenMaker applications.
- Install Microsoft .NET Compact Framework 2.0. Download it from <http://www.microsoft.com/download>
- Install FlexPendant SDK with the same version as the RobotWare on the target controller. Download it from <http://developercenter.robotstudio.com/>

For more information on the system requirements, hardware requirements, and the supported Operating Systems, see *RobotStudio Release Notes*.

Testing on Virtual/Real controller

Best practices

You must test the screenmaker application on the virtual controller against a virtual FlexPendant. Having LAN capabilities through the PC Interface option would be helpful.

Testing and Deploying to a Virtual Controller

Click **Deploy** in the ScreenMaker to deploy to the connected controller in the application. In a virtual controller, the application is deployed directly, which can be used for viewing your application quickly on virtual FlexPendant before deploying the same to the real controller.

Testing and Deploying to a Real Controller

Click **Deploy** in ScreenMaker to deploy to the connected controller in the application. PC interface option is needed to deploy an application over LAN to real controller. The application can also be deployed directly through service port.

Launching ScreenMaker

You can launch ScreenMaker either from the **Controller** tab.

- 1 In the **Controller** tab, click the arrow next to the **FlexPendant** icon.
- 2 Click **ScreenMaker**.

Continues on next page

ScreenMaker is launched as a new tab.

The connection to all connected virtual and real controllers can be established.



Note

For more information, see [Managing projects on page 549](#).

11 Controller tab

11.2.5 Restart a controller

11.2.5 Restart a controller

When to restart a controller

Some operations require a restart of the controller to take effect. When working in RobotStudio, you will be notified when a restart is necessary.

Restart

You must restart a controller when:

- You have changed the baseframe of any of the robots belonging to that controller.
 - You have changed the robot's configuration, either with the Configuration Editor or by loading new configuration files.
 - You have added new options or hardware to the system.
 - A system failure has occurred.
-

Advanced restart options

The controller can be restarted with the following advanced restart options:

Option	Description
Reset system	Restarts the controller with the current system and the default settings. This restart discards the changes made to the robot's configuration. It reverts the current system to the state it had when it was installed on the controller (an empty system). This restart deletes all RAPID programs, data and custom configurations that have been added to the system.
Reset RAPID	Restarts the controller with the current system and reinstall RAPID. This restart deletes all RAPID program modules. It can be useful if the system has changed in such a way that the programs no longer are valid, for instance if system parameters used by the program are changed.
Start Boot Application	This restart applies only to real controllers. This restart saves the current system, with the current settings, and starts the boot application on the FlexPendant from which you can choose a new system to start with. You can also configure the controller's network settings from the boot application.
Revert to last auto saved	This restart applies only to real controllers. Restarts the controller with the current system and the last known good settings. This restart restores changes made to the robot's configuration to a previously good state.

Restarting a virtual controller

- 1 In the **Controller** browser, select the controller to restart.
- 2 In the **Controller Tools** group, click the arrow next to the **Restart** icon, and then select one of the following options:

Restart	Restarts the VC and activates the changes made to the system. This is the default option if you directly click Restart .
----------------	--

Continues on next page

Reset system	Restarts the VC with the current system and the default settings.
Reset RAPID	Restarts the VC with the current system and reinstalls RAPID.

The options for **Restart** are also present in the context menu when you right-click a controller in the **Controller browser**.

**Note**

A virtual controller system cannot be moved by copying its folder. Instead, you must use the **Pack&Go** function followed by the **Unpack&Work** function to move the systems to a new location.

Restarting a real controller

The following are the prerequisites for restarting a real controller:

- You must have Write access to the controller you are restarting.
- For the advanced restart method **Start Boot Application**, you must have access to the controller's FlexPendant.

To restart a real controller:

- 1 In the **Controller browser**, select the controller to restart.
- 2 In the **Controller Tools** group, click the arrow next to the **Restart** icon, and then select one of the following options:

Restart	Restarts the real controller and activates the changes made to the system.
Advanced	The controller can be restarted with the following advanced system restart and recovery options: <ul style="list-style-type: none"> • Reset system • Reset RAPID • Start Boot Application (FlexPendant required) • Revert to last auto saved

The options for **Restart** are also present in the context menu when you right-click a controller in the **Controller browser**.

11 Controller tab

11.2.6 Back up a system

11.2.6 Back up a system

Overview

When backing up a system you copy all the data needed to restore the system to its current state:

- Information about software and options installed on the system.
- System's home directory and all its content.
- All robot programs and modules in the system.
- All configuration and calibration data of the system.

Prerequisites

To backup a system you must have:

- Write access to the controller
- Logged on to the controller with appropriate grants. For more information, see [User Authorization on page 162](#).

Creating a Backup

To create a backup, follow these steps:

- 1 In the **Controller** browser, select the system you want to backup from the browser.
- 2 Right-click and select **Create Backup**.
The **Create Backup** dialog box appears.
- 3 Enter a new backup name and specify a location for the backup, or keep the default ones.

You can create backup either in the PC or in the controller disk using the following options, **Browse File System** or **Browse Controller**.

- To create a backup in the PC, select **Browse File System** and then select the destination folder.
- To create a backup in the controller disk, select **Browse Controller** and then select the destination folder in the controller disk.



Note

Do not select **Home** folder when you specify the destination folder for backup.

- 4 Select the checkbox **Backup to archive file** to archive the backup as a `.tar` file. The backup can be archived in both the local PC and the controller disk.



Note

For RobotWare versions prior to 6.06, the backup is archived as a `.zip` file in the local PC alone.

- 5 Click **OK**.

Continues on next page

The progress of the backup is displayed in the Output window.

Backup folder

When the backup is complete you will have a folder with the name of the backup in the specified location. This folder contains a set of subfolders which together comprise the backup.



CAUTION

If the contents of the Backup folder are changed, then it will not be possible to restore the system from backup.

Subfolders	Description
BACKINFO	Contains information necessary for re-creating the system's software and options from the mediapool.
HOME	Contains a copy of the system's home directory content.
RAPID	Contains one subfolder for each task in the system's program memory. Each of these task folders contains separate folders for program modules and system modules.
SYSPAR	Contains the system's configuration files.



Note

The contents of the PIB board of a IRC5P system (a controller system for painting) will not be included with the regular RobotStudio backup. Please use the backup function of the FlexPaintPendant to include the PIB content.

11 Controller tab

11.2.7 Restore a system

11.2.7 Restore a system

Overview

When restoring a system from backup, the current system gets the same content as when the backup was performed. Restoring a system replaces the following contents in the current system with the content from the backup:

- All RAPID programs and modules in the system.
- All configuration and calibration data of the system.



Note

The system's home directory and all its content are copied from the backup to the current system.

Prerequisites

To restore a system you must have:

- Write access to the controller.
- Logged on to the controller with appropriate grants. For more information, see [User Authorization on page 162](#).

Restoring a system



Note

Before proceeding, make sure that the system from the backup is compatible with the controller you are restoring.

To restore a system, follow these steps:

- 1 In the **Controller** browser, select the system you want to restore.
- 2 Click **Backup** and select **Restore Backup**.

The Restore from Backup dialog box appears.



Note

Select the **Include Controller Settings** check box to restore the UAS settings, time settings and IP address, and select **Include Safety Settings** check box to include the safety settings.

- 3 In the **Restore from Backup** dialog box, browse to the source folder either in the PC or in the controller disk and then select the backup to restore the system.



Note

If the backup file being restored is a `.zip` file, then it can only be restored from the local PC.

- 4 Click **OK**.

Continues on next page

The progress of the restore appears in the Output window. The controller is automatically restarted to load the restored system.



Note

If the system from the backup does not originate from the controller you are restoring, you get the following message about the mismatch.

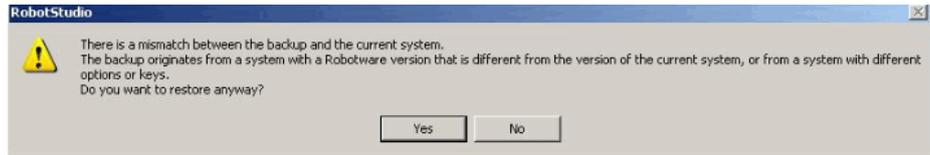

en0900001061

11 Controller tab

11.2.8 System Builder

11.2.8 System Builder

Functions of the System Builder

For procedures using the various functions of the System Builder, see [About System Builder on page 164](#).

11.2.9 Installation Manager

Functions of Installation Manager

For procedures using various functions of the Installation Manager, see [About Installation Manager on page 183](#).

11 Controller tab

11.2.10 Configuration editor

11.2.10 Configuration editor

Configuration editor

From the Configuration Editor you view and edit the system parameters of a specific topic in a controller. The Instance Editor is a complementary editor with which you edit the details of a type instance (a row in the Configuration Editor's instance list). The Configuration Editor has a direct communication with the controller. This means that changes you make are applied to the controller as soon as you complete the command.

With the Configuration Editor, including the Instance Editor, you can:

- view types, instances, and parameters
- edit instances and parameters
- copy and paste instances within a topic
- add and delete instances

Layout of the Configuration Editor

The Configuration Editor consists of the Type name list and the Instance list.

The **Type name** list displays all available configuration types for the selected topic. The list of types is static. This means you cannot add, delete or rename types.

The **Instance** list displays all system parameters of the type selected in the **Type name** list. Each row in the list is an instance of the system parameter type. The columns show each specific parameter and its value for each instance of the parameter type.

The Configuration editor has the following options:

- Controller
- I/O
- Communication
- Motion
- Man-machine communication
- Add Signals

Click the header of a column to sort the column. For sorted columns, the sort order will be reversed. If you press the SHIFT key and click multiple column headers then the columns will be sorted by the order clicked.

Add Signals

You must have write access to the controller to be able to open the add signal window.

Type of Signal	Defines the type of signal.
Signal Base Name	Defines the name for one or more signals.
Assigned to Device	Defines the device to which the signal belongs.
Signal Identification Label	Optionally, offers filtering and sorting based on this category.
Number of Signals	Defines the number of signals to add in a range
Start Index	Defines the index (number) to start the range with.

Continues on next page

Step	Defines the number which the index should increase with.
Device Mapping Start	Defines the bits in the I/O memory map of the assigned unit to which the signal is mapped.
Category	Optionally, offer filtering and sorting based on this category.
Access Level	Defines the write access to I/O signals for categories of I/O controlling clients connected to the robot controller. This field is enabled only when Advance checkbox is selected. Not necessarily Write access. Options are Default, ReadOnly and All.
Default Value	Specifies the I/O signal value to be used at the start.
Invert Physical Value	Applies an inversion between the physical value of the signal and its logical representation in the system.

Layout of the Instance editor

The Instance Editor lists the parameters and their values in the open instance.

In the **Value** column you can view and edit the value of the parameter.

When you click a row, the lower section of the Instance Editor window displays the type of parameter, restrictions for the parameter value and other conditions for the parameter.

11.2.11 Load Parameters

Prerequisite

You must have write access to the controller.

Loading a configuration file

You can load a configuration file either from the system or from the controller disk.

- 1 In the **Controller** browser, select the system and expand the **Configuration** node.
- 2 To load a configuration file from the system, click **Load Parameters** to bring up a dialog box.
To load a configuration file from the controller disk, click **Load Parameters from Controller**, to bring up a dialog box.
- 3 In the dialog box, select how you want to combine the parameters in the configuration file to load with the existing parameters:

If you want to...	then select...
replace the entire configuration of the topic with the one in the configuration file.	Delete existing parameters before loading
add new parameters from the configuration file to the topic, without modifying the existing ones.	Load parameters if no duplicates
add new parameters from the configuration file to the topic and update the existing ones with values from the configuration file. Parameters that only exist in the controller and not in the configuration file will not be changed at all.	Load parameters and replace duplicates

- 4 Click **Open** and browse to the configuration file to load. Then click **Open** again.
- 5 In the information box, click **OK** to confirm that you want to load the parameters from the configuration file.
- 6 When the loading of the configuration file is finished, close the Select mode dialog box.

If a restart of the controller is necessary for the new parameters to take effect, you will be notified of this.

11.2.12 Save Parameters

Overview

The system parameters of a configuration topic can be saved to a configuration file, stored on the PC or any of its network drives.

The configuration files can then be loaded into a controller. They are thereby useful as backups, or for transferring configurations from one controller to another.

File-naming conventions

The configuration files should be named with a name that relates to their corresponding topics. When saving configuration files, the correct name for each file will be suggested by default.

Saving a configuration file

You can save a configuration file either in the system or in the controller disk.

- 1 In the **Controller** browser, select the system and expand the **Configuration** node.
- 2 To save a configuration file in the system, click **Save Parameters** and then select the topic to save to a file and click **Save**.
To save a configuration file in the controller disk, click **Save Parameters to Controller** and then select the topic to save to a file and click **Save**.
- 3 In the **Save As** dialog box, browse for the folder to save the file in.
- 4 Click **Save**.

Saving several configuration files

- 1 Select the **Configuration** node.
- 2 Click **Save System Parameters**.
- 3 In the **Save System Parameters** dialog box, select the topics to save to files. Then click **Save**.
- 4 In the **Browse for Folder** dialog box, browse for the folder to save the files in.
Then click **OK**.
The selected topics will now be saved as configuration files with default names in the specified folder.

11 Controller tab

11.2.13 Transfer

11.2.13 Transfer

Overview

The transfer function allows easy transfer of offline-created RAPID programs to the real robot on the shop floor. This means that you can transfer data from a virtual controller (which is offline) to a real controller (which is online). As part of the transfer function you can also compare the data present in the virtual controller with that present in the real controller and then select which data to transfer.

You can also use the transfer function to transfer data from a virtual controller to another virtual controller.

Relations for transfer of data

To transfer data, you must first set up a **Relation** between the two controllers. A Relation defines the rules for the transfer of data between the two controllers.

Creating a Relation

When you have two controllers listed in the Controller browser, you can create a Relation between them. To create a Relation:

- 1 On the **Controller** tab, in the **Transfer** group, click **Create Relation**.
The Create Relation dialog box is displayed.
- 2 Enter a **Relation Name** for the relation.
- 3 Specify the **First Controller**, from the list.
The First Controller, also called the Source, owns the data being transferred.
- 4 Specify the **Second Controller**, from the list. This can either be a real controller or another virtual controller.
The Second Controller, also called the Target, receives the data being transferred.
- 5 Click **Ok**.
The relation between the controllers is now created.

After this, the *Relation* dialog box opens, using which you can configure and execute the transfer. Relations of a controller are listed under its Relations node in the Controller browser.



Note

The properties of the relation are saved in a XML file under INTERNAL in the owner controller's system folder.

Transferring data

You can configure the details of the transfer of data and also execute the transfer, in the *Relation* dialog box.

Continues on next page

To open the *Relation* dialog box, double-click a relation. Alternatively, select a relation in the **Controller** browser, and then in the **Transfer** group, click **Open Relation**.

Configuring the transfer

Before executing a transfer, you can configure the data to be transferred, under the *Transfer Configuration* heading. Configure using these guidelines:

- Use the check boxes in the *Included* column to include or exclude the corresponding items shown in the tree structure. All items in a module that are included will be transferred. Other non-listed items of a module such as comments, records and so on will be automatically included in the transfer.
- The *Action* column shows a preview of the transfer's result, based on the items you include or exclude.
- If a module exists both in the source and the target controllers, and the *Action* column shows *Update*, then click **Compare** in the *Analyze* column. This opens the *Compare* box which shows two versions of the module in different panes. The affected lines are highlighted and you can also step through the changes. You can choose one of the following options for the comparison:
 - **Source with target** - Compares the source module with the target module
 - **Source with result** - Compares the source module with the module that will be the result of the transfer operation
- BASE (module), wobjdata and tooldata are excluded by default.
- wobjdata wobj0, tooldata tool0, and loaddata load0 of the BASE module are unavailable for inclusion.

A task can be transferred only if:

- Write access to the target controller is present (must be manually retrieved).
- Tasks are not running.
- Program execution is in the stopped state.

Executing the transfer

After you have configured the transfer, you can execute it.

Under the *Transfer* heading, the Source and Target modules are shown along with the arrow showing the direction of the transfer. You can change the direction of the transfer by clicking **Change Direction**. This also switches the source and target modules.

To execute the transfer click **Transfer now**. A dialog showing a summary of the transfer appears. Click **Yes** to complete the transfer. The result of the transfer is displayed for each module in the output window.

The **Transfer now** button is disabled if:

- None of the included tasks can be transferred.
- Write access is required but not held.

Continues on next page

11 Controller tab

11.2.13 Transfer

Continued



Note

If one of several modules fail, then the following error message is displayed.

```
Module xxx.zzz has failed. Do you want to continue?
```

11.2.14 Signal Analyzer Online

Analyzing signals from the controller

The Signal Analyzer Online functionality helps in displaying and analyzing signals from a robot controller. Using the Signal Analyzer, you can optimize the robot program.

The Signal Analyzer functionality is present for both virtual and real controllers. The following section describes the Signal Analyzer functionality for real controllers. For information on the Signal Analyzer Online functionality for virtual controllers, see [Signal Analyzer on page 368](#).

To open the Signal Analyzer Online, on the **Controller** tab, in the **Controller Tools** group, click **Signal Analyzer Online**. Alternatively, you can open the Signal Analyzer Online using the context menu in the Signal History window.



Note

The Signal Analyzer Online command in the Controller Tools group is enabled only if the selected controller is a real controller, or if the controller tree has only one real controller.

For information about the layout of the Signal Analyzer Online, see [Layout of Signal Analyzer on page 373](#).

Turning the signal recording on and off

To turn the recording of signals on or off, use the **Start recording** and **Stop recording** buttons.

To start the recording, click **Start recording**.

To stop the recording, click **Stop recording**. The recording stops and the recorded session is saved.

Configuring signals for the next recording

To configure the signals which are to be saved during the next signal recording session, use the **Signal Setup** window. For this, click the arrow next to the **Signal Analyzer** icon, and then click **Signal Setup**. The **Signal Setup** window appears.

The signals that are available for configuration are shown in the **Signal Setup** window. For the list of available signals, see [Available signals on page 369](#).

For information on setting up the signals, see [Setting up the signals on page 371](#).

Continues on next page

11 Controller tab

11.2.14 Signal Analyzer Online

Continued

History

The signal data from each signal recording session is saved. To view these, click the arrow next to the **Signal Analyzer** icon, and then click **History**. For more information, see [History on page 376](#).



Note

The signal data from each signal recording session is saved as a .sdf file at the following location. The History feature uses these files.

```
C:\Users\<your user name>\AppData\Local\ABB Industrial  
IT\Robotics IT\RobotStudio\SignalAnalyzer
```

This path is for a PC with a standard installation of Windows 7 or 8 (English version). The path may differ if you have a customized installation or use Windows XP.

11.2.15 Safety Configuration

Overview

For information on safety configuration, see:

- *Application manual - SafeMove*
- *Application manual - Electronic Position Switches*

11 Controller tab

11.2.16 Collision Avoidance

11.2.16 Collision Avoidance

Overview

The Collision avoidance functionality prevents the collision between the arms in a dual arm robot.

To enable this feature, in the **Controller** browser, right-click any controller and then click **Collision Avoidance** and then select **Activate Collision Avoidance**.

Visualizing collision avoidance

It is possible to view collision avoidance. You can view possible collisions in online monitor. To enable this feature, in the **Controller** browser, right-click any controller and then click **Collision Avoidance** and then select **Show predicted collisions**. During collision, object in the collision path gets highlighted.

11.3 Features for real controllers

11.3.1 Request Write Access

Overview

You need Write access for editing programs and configurations or in any other way to change data on the controller.

Prerequisites for Write access

You can get Write access to any controller as long as the prerequisites are fulfilled.

When the Controller is in Mode:	This has to be fulfilled:
Auto	The Write access must not be taken by any other user.
Manual	The remote Write access must be granted on the FlexPendant. For safety reasons, a FlexPendant user can also recall this remote Write access in manual mode.

If the prerequisites are not fulfilled you will be denied, or lose, the Write access. This means that if you have Write access in auto mode and the controller is switched over to manual mode you will lose the Write access without any warning. This is because the FlexPendant unit by default has the Write access in manual mode, for safety reasons. The same will happen if the remote Write access in manual mode is recalled from the FlexPendant unit.

Result

The Controller Status window will be updated when the request for Write access is granted.

If the Write access is denied, a message is displayed.

11 Controller tab

11.3.2 Release Write Access

11.3.2 Release Write Access

Overview

Several users can be logged on to a single controller but only one can have the write access. You can release the write access when you do not need it anymore.

Result

The Controller Status window will be updated when your access right has changed from read/write to read only.

11.3.3 Authenticate

Overview

The data, functionality, and commands on a controller are protected by a User Authorization system (also called UAS). The UAS restricts the parts of the system the user has access to. Different users can have different access grants.

You can perform the following functions from the **Authenticate** menu:

- Login as a Different User
- Log off
- Log off all controllers
- Edit User Accounts
- UAS Grant Viewer

Login as a Different User

- 1 In the **Authenticate** menu, click **Login as a Different User**. The **Add new user** dialog box appears.
- 2 In the **User Name** box, enter the user name you want to log on as.
- 3 In the **Password** box, enter the password for the user name you are logging on as.
- 4 Click **OK**.

Note: If you have previously logged on as a different user and wish to revert as default user, click **Login as Default User**.

Log off

In the **Authenticate** menu, click **Log off** to log the user off from the controller.

Login off all controllers

In the **Authenticate** menu, click **Log off** to log the user off from all the controllers.

Edit User Accounts

For more information on User Accounts, see [User Accounts on page 423](#).

UAS Grant Viewer

For more information on UAS Grant Viewer, see [UAS Grant Viewer on page 428](#).

11 Controller tab

11.3.4 File transfer

11.3.4 File transfer

Overview

You can transfer the files and folders between the PC and a controller through the File Transfer window.

Prerequisites

The following are the prerequisites to be met:

- The PC must be connected to the same network as the controller, or connected to the service port of the controller.
 - You must be logged on to the controller as a user with UAS grants that allows file transferring.
-

Transferring files and folders

Use this procedure to transfer files and folders between the PC and a controller:

- 1 In the **Controller Tools** group, click **File Transfer**.
The **File Transfer** window appears.
- 2 In the **PC explorer**, browse to the folder from or to which you want to transfer the data.
- 3 In the **Controller explorer**, browse to the folder from or to which you want to transfer the data.
- 4 Select the item to transfer from the list.

To select several items at once, do one of the following:

To select	then press
several adjacent items	the SHIFT key and select the first and the last item.
several non-adjacent items	the CTRL key and select each item.
all items in the list	the keys CTRL + A

- 5 When the files and folder to transfer are selected, do one of the following:

To	then press
cut the files	CTRL + X
copy the files	CTRL + C , or click Arrow

Continues on next page

- 6 Place the insertion point either in the **PC explorer** or the **Controller explorer** and click CTRL + V.



Note

In the **PC explorer** or **Controller explorer** window, right-click to view the following context menu:

- Transfer
- One level up
- Open
- Refresh
- Cut
- Copy
- Paste
- Delete
- Remove

11 Controller tab

11.3.5 FlexPendant Viewer

11.3.5 FlexPendant Viewer

Overview

FlexPendant Viewer is an add-in to RobotStudio that retrieves and displays a screenshot from the FlexPendant. The screenshot is generated automatically at the moment of the request.

Prerequisites

The controller you want to retrieve screen shots from must be added to your robot view.

A FlexPendant must be connected to the controller. If no FlexPendant is currently connected (option *Hot plug* is installed and the jumper plug is used) then no screen shot can be retrieved.

Using FlexPendant Viewer

- 1 Make sure you are connected to the controller.
- 2 In the **Controller Tools** group, click the arrow next to the **FlexPendant** icon, and then click **FlexPendant Viewer**.
A screen shot will be displayed in the workspace.
- 3 To reload the screen shot, click **Reload** in the workspace.
- 4 To set an automatic reload period for the screen shot, click on the menu **Tools**, point to **FlexPendant Viewer** and click **Configure**.
Set the desired reload period and select the check-box **Activated**. Then click **OK**.

Results on the controller

The screenshot will automatically be saved as a file on the controller. When a new request is sent, a new screenshot is generated and saved, overwriting the previous file.

No message will be displayed on the FlexPendant.

11.3.6 Import Options

Importing system options

- 1 In the **Configuration** group, click **Import Options** to bring up a dialog box.
- 2 In the **Option source** box, enter the path to the folder where the options to import are located. You can also click the **Browse** button and browse to the folder.
- 3 In the **Media Pool destination** box, enter the path to the media pool you want to store the options in. You can also click the **Browse** button and browse to the media pool folder.
- 4 Select the options to import and click **Import**.

To select several options at once, do one of the following:

To select	then hold down
several adjacent options	the SHIFT key and select the first and the last option.
several non-adjacent options	the CTRL key and select each option.

- 5 Click **OK**.

Removing system options

- 1 In the **Configuration** group, click **Import Options** to bring up a dialog box.
- 2 In the **Media Pool destination** list, enter the path to the media pool from which you want to delete the options. You can also click the **Browse** button and browse to the media pool folder.
- 3 Select the options to delete and click **Remove**.

To select several options at once, do one of the following:

To select	then hold down
several adjacent options	the SHIFT key and select the first and the last option.
several non-adjacent options	the CTRL key and select each option.

- 4 Click **OK**.

11 Controller tab

11.3.7 Properties

11.3.7 Properties

Overview

You can perform the following actions from the **Properties** menu:

- Renaming the controller
- Setting the controller date and time
- Setting the Controller ID
- Viewing controller and system properties
- Handling the Device Browser

Renaming the controller

The controller name is an identification of the controller that is independent of the system or the software running on the controller. Unlike the controller ID, the controller name does not have to be unique for each controller.



Note

The controller name must be written with characters from the ISO 8859-1 (Latin 1) character set.

- 1 In the **Configuration** group, click **Properties**, and then click **Rename**.
The **Rename Controller** dialog box appears.
- 2 Enter the new name of the controller in the dialog box.
- 3 Click **OK**.

The new name will be activated when the controller is restarted.

You will be prompted to either click **Yes** to restart the controller immediately or click **No** to restart later.

Setting the controller date and time

You can either set the date and time to the same as the network time server, or you can specify the date and time manually.

Use this procedure to set the controller date and time:

- 1 In the **Configuration** group, click **Properties**, and then click **Date and Time**.
The **Set Date and Time** dialog box appears.
- 2 This dialog provides two options: **Network Time** and **Manual Time**.
 - Select **Network Time** and in the **Time server address** box, enter the IP address of the network time server.
 - Select **Manual time** and then set the **Date** and **Time** in the boxes provided. You can select the required time zone in the **Time zone** list.

Setting the Controller ID

The Controller ID is by default set to the serial number of the controller and is thereby a unique identifier of the controller.

The Controller ID is a unique identifier for the controller and should not be changed.

Continues on next page

However, if the hard disk of the controller is replaced, the ID will be lost and you must set it back to the serial number of the controller.

**Note**

You must **Request Write Access** to the controller before setting the controller ID.

- 1 In the **Configuration** group, click **Properties**, and then click **Controller ID**. The **Set Controller ID** dialog box appears.
- 2 Enter the Controller ID and then click **OK**.

**Note**

Use only characters from the ISO 8859-1 (Latin 1) character set and no more than 40 characters.

Setting the IP address of the controller

You can set the controller to receive the IP address from the network's DHCP server or you can manually set the IP address of the controller.

- 1 On the **Controller** tab, in the **Configuration** group, Click **Properties** and then click **Network settings**.
The Network settings dialog opens.
- 2 Select **Obtain an IP address automatically** to set the controller to receive the IP address from the network's DHCP server.

OR

Select **Use the following IP address** and then enter the required **IP address** and **Subnet mask** boxes to manually set the IP address of the controller.

Viewing controller and system properties

You can view the following properties for a controller and its running system.

Controller Properties	System Properties
Boot Application	Control Module
Controller ID	Drive Module #1
Controller Name	Serial Number
Installed Systems	System Name
Network Connections	

- 1 In the **Configuration** group, click **Properties**, and then click **Controller and System Properties**.
The **Controller and System Properties** window appears.
- 2 In the tree view at the left of the window, browse to the node for which you want to view the properties.
The properties of the selected object are displayed in the Properties list to the right of the window.

Continues on next page

11 Controller tab

11.3.7 Properties

Continued

Viewing the Device Browser

The Device Browser displays the properties and trends of the various hardware and software devices in a robot controller. To open the Device Browser, in the Configuration group, click **Properties**, and then click **Device Browser**.

Displaying the properties of a device

In the tree view, browse to the node for which you want to view the properties and then click it. The properties of the selected object, along with their corresponding values, are listed to the right of the tree view.

Updating the tree view

Press **F5**, to update the tree view.

Alternatively, right-click inside the tree view pane, and then click **Refresh**.

Displaying a trend

Select a device in the tree view and then double-click any property, that has a numerical value, in the right-hand panel. This opens a trend view. The trend view collects data at a rate of one sample per second.

Hiding, stopping, starting or clearing a trend

Right-click anywhere on the trend view and then click the required command.

Saving system diagnostics

You can create a System Diagnostics data file from RobotStudio.

To save a System Diagnostics data file to your PC, in the Configuration group, click **Properties**, and then click **Save system diagnostics**.

11.3.8 Go Offline

Overview

The main purpose of this feature is to create a new station with a VC similar to the connected real controller. This helps a robot technician to work offline, and not just when connected to the real controller.

Using Go Offline

- 1 Connect the PC to a real controller.
- 2 On the **Controller** tab, click **Request Write Access**.
For more information on Request Write Access, see [Request Write Access on page 409](#).
- 3 Click **Go Offline**.
The **Go Offline** dialog box is displayed.
- 4 Enter a name for the system and browse for the location to save the system.
A new station is created with a VC with the same configuration as the real controller.



Note

A pre-requisite is that any RobotWare add-ins used by the system must be available on the PC. A Relation is automatically created between the virtual controller and the real controller. For more information on Relations, see [Transfer on page 402](#)

11 Controller tab

11.3.9 Online Monitor

11.3.9 Online Monitor

Overview

This feature allows you to remotely monitor the robot connected to a real controller. It displays a 3D layout of the connected robot controller and enhances user's current perception of reality by adding motion visualization augmentation.



Note

The Online Monitor shows TCP robots and TCP robots with track. When connecting the Online Monitor to a virtual controller, the motion is shown only if the virtual controller is using Free-Run mode, not the Time Slice mode.

Using Online Monitor

The following procedure describes the Online Monitor feature in RobotStudio:

- 1 Connect the PC to a controller and add the controller. See [Add Controller on page 382](#).
- 2 Click **Online Monitor**.

The 3D view of the mechanical units of the controller system is displayed in the graphics window.



Note

The robot view is refreshed every second with the current joint values of all the mechanical units.

Gravity parameters in online monitor

Online Monitor displays the orientation of a robot according to its gravity parameters. The Gravity Alpha, Gravity Beta and Gamma Rotation parameters define the rotation of the robot around the X, Y and Z axis in the world coordinate system. The Online Monitor orients the robot in the Graphical view according to the gravity parameters.

These parameters describe how the robot is oriented in relation with the floor or ground, whether it is suspended (mounted on the ceiling), shelf mounted (mounted on the wall), or mounted on the regular floor. If the robot is configured to be mounted on the ceiling, it will be displayed upside down in the Online Monitor. You can set these parameters in the **Motion configuration file**.

For more information about gravity parameters, see *Technical reference manual - System parameters*

Indication of TCP

A cone is automatically created to indicate the active tool data being used. The cone has its base in the robot wrist and its tip at the location of the tool data.

Continues on next page

Kinematic Limitations

When the Kinematic Limitation button is enabled, the graphical 3D viewer indicates whether the robot is at a joint limit or at a singularity.

For joint limits, the corresponding link is highlighted in yellow to indicate a warning and in red to indicate an error. The tolerance limits are defined in RobotStudio Options - Online - Online Monitor.

For singularity, a markup indicates when the axis 5 is close to singularity. The singularity level is also defined in RobotStudio Options.

Visualizing Safety Zones in Online Monitor

This feature lets you to visualize the current status of the manipulators in a robot system and provides an augmented reality of the robot cell. It allows you to visualize a failure scenario, for example, an unplanned stopping of a robot. To give the user an idea of the physical layout and the safety zone that has caused this stopping of the robot, safety zones are visualized in online monitor. When the robot enters a restricted zone, the safemove supervision feature stops the robot.

Features

- A **Show Safety Zones** button is available in the Online Monitor for each manipulator in the system, for example, four buttons in a MultiMove system with four manipulators.
- The name of each tool zone and the corresponding manipulator is shown as a markup, for example, Rob1 STZ1, ..., Rob4 STZ8, Rob1 MTZ1, ..., Rob4 MTZ8 and so on.
- Zones that are defined as **Allow inside** are visualized as a green semitransparent hollow shape.
- Zones that are defined as **Allow outside** are visualized as a red semitransparent solid shape.
- A message is displayed in the output window if no STZ or MTZ is defined for the manipulator.
- The controller event log message **20468 SC STZ violation** is displayed in the output window if it is present in the controller event log.

**Note**

You can open one SafeMove Configurator at a time, even though several controllers may be connected. If the SafeMove Configurator is opened for one controller, real or virtual, the icon gets disabled for the other controllers.

11 Controller tab

11.3.10 Visual SafeMove

11.3.10 Visual SafeMove

Overview

Visual SafeMove is a 3D based configuration tool for SafeMove. The tool is completely integrated into the RobotStudio user interface and takes full advantage of the user interface elements such as tabs, browsers, and 3D graphics. Visual SafeMove is enabled for robots with the SafeMove option. It offers an intuitive way to visualize and configure safety zones. Visual SafeMove works both with the real controller and the virtual controller. The Visual SafeMove configurator is available alongside with the previous configurator.

Only a safety user is allowed to download a configuration. A safety user must be created before configuring SafeMove. For more information on visual safemove configurator, see *Operating Manual- SafeMove*.



Note

You can open one SafeMove Configurator at a time, even though several controllers may be connected. If the SafeMove Configurator is opened for one controller, real or virtual, the icon gets disabled for the other controllers.

Starting Visual SafeMove

- 1 Start a RobotStudio station, a virtual controller, or connect to a real controller.
- 2 In the RobotStudio **Controller** browser, right-click on the controller and select **Authenticate** and then **Login as a Different User**.
- 3 Select the safety user, for example, SafetyUser. Type the password and click **Login**.
- 4 In the **Controller** tab, click **Online Monitor**. (Not needed when running a RobotStudio station.)
- 5 In the **Controller** tab, click **Safety**, then select **Visual SafeMove**.

11.3.11 User Accounts

Overview

All the procedures below require the following steps to be taken before managing the details:

- 1 In the **Controller** browser, select the controller to which you want to manage a user or group
- 2 From the **Controller** tab, click **Request Write Access** to provide write access to the controller.
- 3 In the **Controller** tab, click **Authenticate** and select **Edit User Accounts**, for administering UAS accounts, grants, and groups.

Users tab

With the Users tab you set which users will be able to log on to the controller and which groups the users shall belong to.

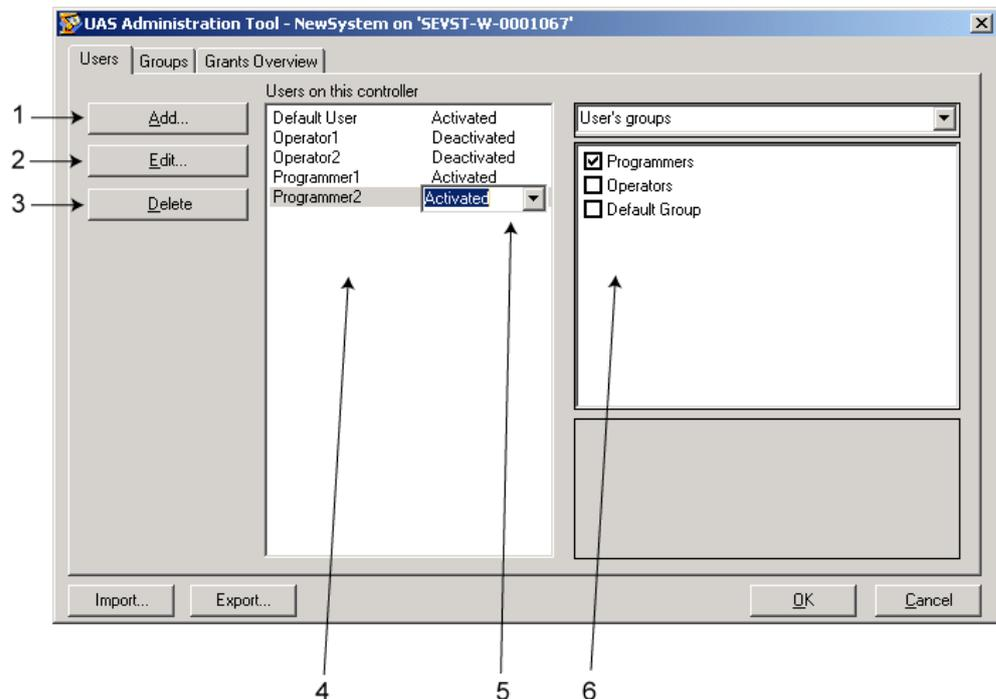

users-ta

Users tab Parts

- 1 The **Add** button. Opens a dialog box for adding new users.
- 2 The **Edit** button. Opens a dialog box for changing the log on name and password of the user.
- 3 The **Delete** button. Deletes the selected user account from the controller.

Continues on next page

11 Controller tab

11.3.11 User Accounts

Continued

- 4 The **Users on this Controller** list. Shows the user accounts defined on this controller. The list has two columns:

Column	Description
User	The name of the user account
Status	Shows if the account is activated or deactivated. When deactivated, it is not possible to log on using that account.

- 5 The **Activated/Deactivated** item box. Changes the status of the user account.
- 6 The **User's groups/User's grants** list.

The **User's groups** list shows which group(s) the user is a member of. For changing the membership of a group, select or clear the checkbox in front of the group name.

The **User's grants** list shows the available grants for the selected User's group(s). When selecting a grant from the User's grants list, a description of the selected grant appears.

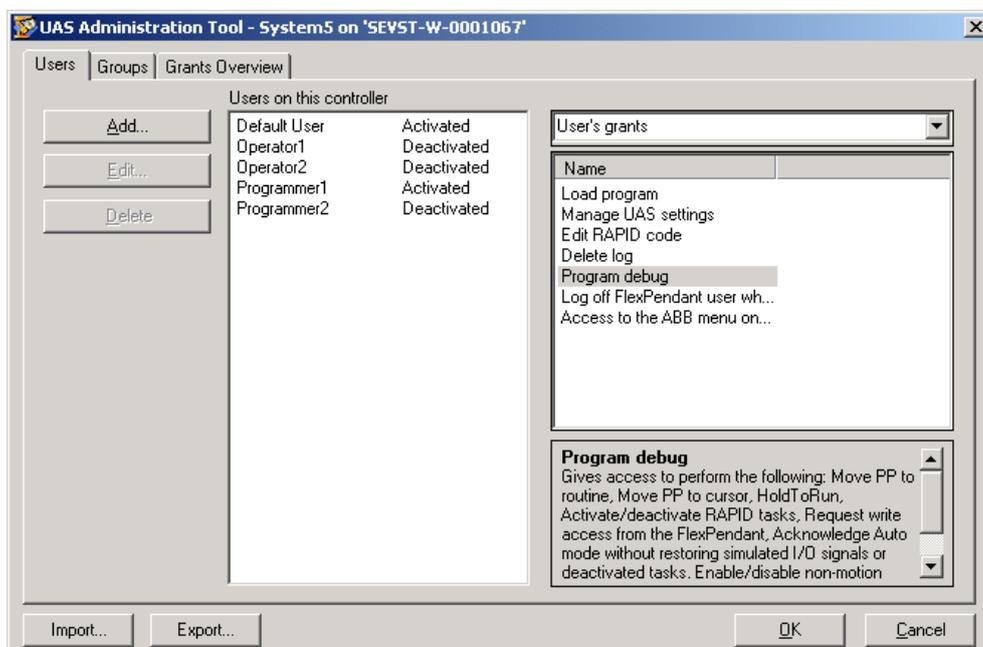

users-t0

Adding a user

- 1 On the **Users** tab, click **Add** to bring up a dialog box.
- 2 In the **User Name** box, enter the user name. Use only characters from the ISO 8859-1 (Latin 1) character set and no more than 16 characters.
- 3 In the **Password** box, enter the user's password. The password you type in will not be visible. Use only characters from the ISO 8859-1 (Latin 1) character set and no more than 16 characters.
- 4 In the **Retype Password** box, enter the user's password again.
- 5 Click **OK** to add the new user and close the dialog box.
- 6 Click **OK**.

Continues on next page

Deleting a user

- 1 On the **Users** tab, select the user to delete from the **Users on this controller** list and click **Delete**.
- 2 To the question **Are you sure you want to remove this user?**, answer **Yes**.
- 3 Click **OK**.

Setting up group membership

- 1 On the **Users** tab, select the user from the **Users on this controller** list.
- 2 In the **User's groups** list, select the groups the user shall be a member of.
- 3 Click **OK**.

Changing a name or password

- 1 On the **Users** tab, select the user to edit from the **Users on this controller** list and click **Edit user**.
This opens the **Edit** dialog box.
- 2 To change the user name, enter the new name in the **User Name** box. Use only characters from the ISO 8859-1 (Latin 1) character set and no more than 16 characters.
- 3 To change the password, enter the new password in the **Password** box, then retype the password in the **Retype Password** box. Use only characters from the ISO 8859-1 (Latin 1) character set and no more than 16 characters.
- 4 Click **OK** to save the changes to the user and close the dialog box.
- 5 Click **OK**.

Activating or deactivating a user

- 1 On the **Users** tab, select the user from the **Users on this controller** list and click the status text (**Activated** or **Deactivated**). An item box appears and you can change the status.
The user's new state is now displayed in the status column of the **Users on this controller** list.
- 2 Click **OK**.

Exporting a user list

- 1 On the **Users** tab, select the user from the **Users on this controller** list and click **Export**.
- 2 Browse to the destination folder and click **OK**. The **File password** dialog opens, type in the password and click **OK**.
- 3 This opens a **Save as** dialog box, in which you specify the name and location for the file with the user list.

Importing a user list

- 1 On the **Users** tab, select the user from the **Users on this controller** list and click **Import**.
- 2 Browse to the file location and click **OK**. The **File password** dialog opens, type in the password and click **OK**.

Continues on next page

11 Controller tab

11.3.11 User Accounts

Continued

- 3 This opens an **Open file** dialog box, in which you browse to the file with the list to import.

When you have selected the file, the **ImportOptionsForm** dialog opens.

Select ...	Description
Delete existing users and groups before importing	Earlier groups and users will be deleted.
Advanced options	A new dialog appears. <ul style="list-style-type: none">• Import users but don't replace duplicates means that you will not replace the existing users.• Import users and replace duplicates means that you will replace the existing users.• Import groups but don't replace duplicates means that you will not replace the existing groups.• Import groups and replace duplicates means that you will replace the existing groups.

Adding a group

- 1 On the **Groups** tab, click **Add**.
This opens the **Add new group** dialog box.
- 2 In the **Group Name** box, enter the name of the group. Use only characters from the ISO 8859-1 (Latin 1) character set and no more than 16 characters.
- 3 Click **OK** to add the new group and close the dialog box.
- 4 Click **OK**.

Renaming a group

- 1 On the **Groups** tab, select the group to rename from the **Groups on this controller** list and click **Rename**.
This opens the **Rename Group** dialog box.
- 2 In the **Group Name** box, enter the name of the group. Use only characters from the ISO 8859-1 (Latin 1) character set and no more than 16 characters.
- 3 Click **OK** to rename the group and close the dialog box.
- 4 You will now be asked if you want the users who belong to this group to continue belonging to a group with the old name as well as the new one.

Click	To
Yes	Let the users of the group be members to groups with both the old and the new name. However, the old group will no longer be defined in the controller's UAS since it is replaced by the new group. This option might be useful if you plan to recreate the old group, or copy the user's settings to another controller who has the old group defined.
No	Delete the user's memberships to the old group. This is to just replace the old group name with the new one.
Cancel	To cancel the change and keep the old group name, with its user's memberships.

- 5 Click **OK**.

Continues on next page

Deleting a group

- 1 On the **Groups** tab, select the group to delete from the **Groups on this controller list** and click **Delete**.
- 2 You will now be asked if you want the users who belong to this group to continue belonging to it though it is not valid.

Click	To
Yes	Let the users of the group remain members to it even if it is no longer defined in the controller's UAS. This option might be useful if you plan to recreate the group, or copy the user's settings to another controller who has the group defined.
No	Delete the user's memberships to the group.
Cancel	Cancel the change and keep the group, with its user's memberships.

- 3 Click **OK**.

Giving grants to a group

- 1 On the **Groups** tab, select the group from the **Groups on this controller list**.
- 2 In the **Controller grants/Application grants** list, select the grants to give to the group.
- 3 Click **OK**.

11 Controller tab

11.3.12 UAS Grant Viewer

11.3.12 UAS Grant Viewer

Overview

The UAS Grant Viewer page displays information about the grants provided to the user currently logged in and the groups owning them.

- 1 In the **Authenticate** menu, click **UAS Grant Viewer**. The **UAS Grants** window appears.

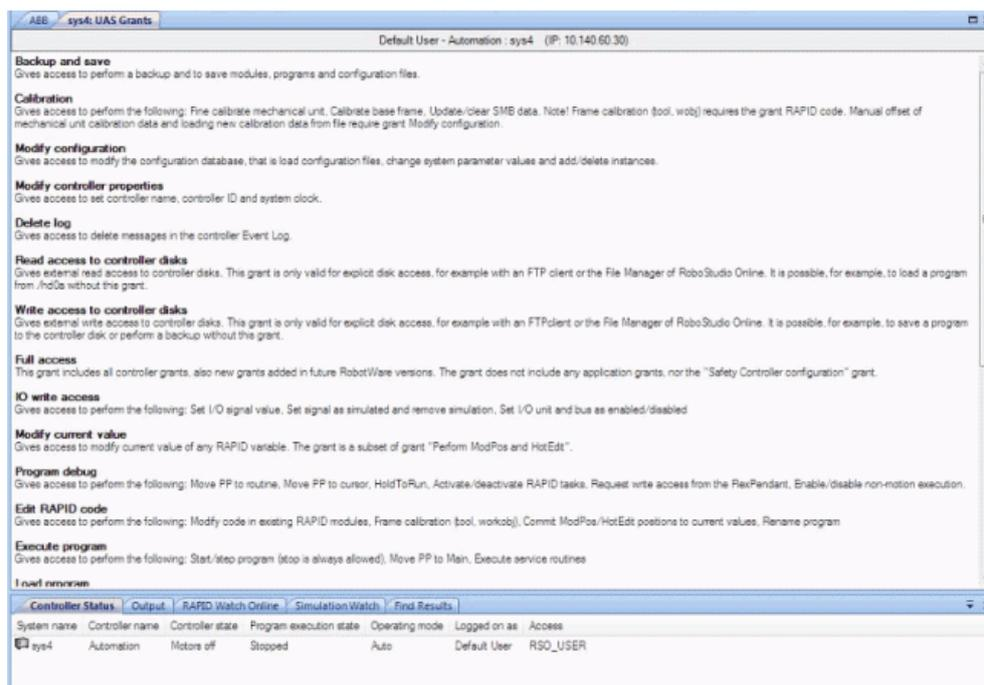

en090000852

Examples of common actions to perform

Action	Necessary grants
Rename the controller (A restart of the controller is necessary)	Modify controller properties Remote restart
Change system parameters and load configuration files	Modify configuration Remote restart
Install a new system	Administration of installed system
Perform a backup (A restart of the controller is necessary)	Backup and save Remote restart
Restore a backup (A restart of the controller is necessary)	Restore a backup Remote restart
Load/delete modules	Load program
Create new module.	Load program
Edit code in RAPID modules	Edit RAPID code
Save modules and programs to disk	Backup and save
Start program execution from Task Window	Execute program

Continues on next page

Action	Necessary grants
Create a new I/O signal, that is, add a new instance of the type Signal (A restart of the controller is necessary)	Modify configuration Remote restart
Set the value of an I/O signal	I/O write access
Access to controller disks from File Transfer window	Read access to controller disks Write access to controller disks

Controller grants

Full access	This grant includes all controller grants, also new grants added in future RobotWare versions. The grant does not include any application grants or the <i>Safety Controller configuration</i> grant.
Manage UAS settings	Gives access to read and write the UAS configuration, that is to read, add, remove and modify UAS users and groups.
Execute program	Gives access to perform the following: <ul style="list-style-type: none"> Start/step program (stop is always allowed) Move PP to Main Execute service routines
Perform ModPos and HotEdit	Gives access to perform the following: <ul style="list-style-type: none"> Modify or teach positions in RAPID code (ModPos) During execution modify positions in RAPID code as single points or as a path (HotEdit) Restore ModPos/HotEdit positions to original Modify current value of any RAPID variable
Modify current value	Gives access to modify current value of any RAPID variable. This grant is a subset of the grant <i>Perform ModPos and HotEdit</i> .
I/O write access	Gives access to perform the following: <ul style="list-style-type: none"> Set I/O signal value Set signal as simulated and remove simulation Set the device and industrial network as enabled/disabled
Backup and save	Gives access to perform a backup and to save modules, programs and configuration files. The grant gives full FTP access to the current systems BACKUP and TEMP directory.
Restore a backup	Gives access to restore backup and restart the controller using the restart mode Revert to last auto saved .
Modify configuration	Gives access to modify the configuration database, that is to load configuration files, change system parameter values and add/delete instances.
Load program	Gives access to load/delete modules and programs.
Remote restart	Gives access to perform restart and shutdown from a remote location. No grant is required to perform restart via a local device, as for example the FlexPendant.
Edit RAPID code	Gives access to perform the following: <ul style="list-style-type: none"> Modify code in existing RAPID modules Frame calibration (tool, workobj) Commit ModPos/HotEdit positions to current values Rename program

Continues on next page

11 Controller tab

11.3.12 UAS Grant Viewer

Continued

Program debug	Gives access to perform the following: <ul style="list-style-type: none">• Move PP to routine• Move PP to cursor• HoldToRun• Activate/deactivate RAPID tasks• Request write access from the FlexPendant• Enable/disable non-motion execution
Decrease production speed	Gives access to decrease speed from 100% in Auto mode. This grant is not required if speed is already below 100%, or controller is in Manual mode.
Calibration	Gives access to perform the following: <ul style="list-style-type: none">• Fine calibrate mechanical unit• Calibrate base frame• Update/clear SMB data Frame calibration (tool, wobj) requires the grant <i>Edit RAPID code</i> . Manual offset of mechanical unit calibration data and loading new calibration data from file require the grant <i>Modify configuration</i> .
Administration of installed systems	Gives access to perform the following: <ul style="list-style-type: none">• Install new system• Reset RAPID• Reset system• Start Boot Application• Select System• Install system from device This grant gives full FTP access, that is, the grant gives the same rights as <i>Read access to controller disks</i> and <i>Write access to controller disks</i> .
Read access to controller disks	Gives external read access to controller disks. This grant is only valid for explicit disk access, for example with an FTP client or the File Manager of RoboStudio. It is possible, for example, to load a program from /hd0a without this grant.
Write access to controller disks	Gives external write access to controller disks. This grant is only valid for explicit disk access, for example with an FTP client or the File Manager of RoboStudio. It is possible, for example, to save a program to the controller disk or perform a backup without this grant.
Modify controller properties	Gives access to set controller name, controller ID and system clock.
Delete log	Gives access to delete messages in the controller Event Log.
Revolution counter update	Gives access to update the revolution counter.
Safety Controller configuration	Gives access to perform a configuration of the Safety Controller. This is valid only for the PSC-option and is not included in the <i>Full access</i> grant.

Continues on next page

Application grants

Access to the ABB menu on FlexPendant	Value true gives access to the ABB menu on the FlexPendant. This is the default value if a user does not have the grant. Value false means that the user cannot access the ABB menu when the controller is in Auto mode. The grant has no effect in Manual mode.
Log off FlexPendant user when switching to Auto mode	A user having this grant is automatically logged off from the FlexPendant when switching from Manual mode to Auto mode.

11.3.13 Integrated Vision

The Integrated Vision system provides a robust and easy-to-use vision system for general purpose Vision Guided Robotics (VGR) applications. The system features a complete software and hardware solution that is fully integrated with the IRC5 robot controller and the RobotStudio programming environment. The vision capability leverages on the Cognex® In-Sight® smart camera family, with embedded image processing and an Ethernet communication interface.

RobotStudio has been equipped with a vision programming environment that exposes the full palette of Cognex EasyBuilder® functionality with robust tools for part location, part inspection and identification. The RAPID programming language has been extended with dedicated instructions and error tracing for camera operation and vision guidance.

For more information, see *Application manual - Integrated Vision*.

11.3.14 Jobs

Overview

The Jobs feature allows you to perform certain actions on a large population of robot controllers. A Job is defined by a Device list and an Action. The Action will be carried out for all controllers in the Device list.

Jobs tab

The Jobs feature is managed from the **Jobs** Contextual tab. On the **Controller** tab, in the **Controller Tools** group, click **Jobs** to open the **Jobs** Contextual tab.

The **Jobs** Contextual tab contains the following groups.

Groups	Description
Device Lists	A user-defined group of robot controllers for applying a job. Device lists can be reused between jobs.
Jobs	A command group containing various job options.

Device Lists group

The Device Lists group contains the following commands and controls.

Commands	Description
New Device List	Opens a new empty device list window for creating a new group of robot controllers.
Open Device List	Opens a previously saved device list to edit or review.
Save Device List	Saves the contents of an active device list window to disk in .xlsx format. These files can be edited in Microsoft Excel without changing the grid structure.
Scan Subnet	Populates the active device list window with all controllers that Netscan finds on the local subnet.

Jobs group

The Jobs group contains the following commands and controls.

Commands	Description
New job	Opens a new job window.
Templates	Provides options, Save Job and Edit Job Templates . <ul style="list-style-type: none"> Save Job : Saves the job specification as an .xml file. Edit Job Templates: Allows you to edit an existing template file.
Verify	Verifies the status of the group of robot controllers.
Execute	Executes the user-selected action.
Pause	Temporarily stops an active action.
Resume	Resumes the paused action.
Cancel	Aborts the active job.

Continues on next page

11 Controller tab

11.3.14 Jobs

Continued

Device List window

You can define the population of robot controllers that the job should be applied to, using the **Device List** window. This window contains the metadata of all robot controllers that are part of the group.

- **Network Address:** This field is mandatory. IP address or DNS name of the controller. The controllers can be distributed on multiple subnets. You can add controllers that cannot be directly found by Netscan from the current location.
- **Controller Name:** This is an optional field. This value is used to verify the controller name that can be identified by the network address.
- **System Name:** This is an optional field. This value is used to verify the system name running on the controller that can be identified by the network address.
- **Group:** This is an optional field. This value is used to filter out a subset of robot controllers from a list while executing jobs.
- **Subgroup:** This is an optional field. This value is used to filter out a subset of robot controllers from a list while executing jobs.
- **Comments:** This is an optional field. You can type in comments in this field. If you add a controller to the list using the **Scan Subnet** command, then the system displays **Found by Netscan** message in this field.

Creating a new job

- 1 On the **Controller** tab, in the **Controller Tools** group, click **Jobs**. The **Jobs** contextual tab opens.
- 2 In the **Device Lists** group, click **New Device List**. The **Unnamed Device List** window opens.
This device list can be saved in .xlsx format.
- 3 In the **Device Selection** area, select a device list in the **Device List**. The **Group Filter** list will be populated if the selected list contains data in the **Group** field.
- 4 Enter valid credentials in the **Username** and **Password** boxes, or select **Default Credentials** if the **Default User** has sufficient grants to perform the selected action.
The specified user must be available and this user should have sufficient grants for all controllers.
- 5 In the **Action** list, click the action that you want to perform. Depending on the selected action, additional action specific data might be required.
To configure these actions, you must provide the required data.
- 6 In the **Jobs** group, click **Verify/Execute** to perform the selected action.
Once the action gets completed, a report and a log file are created. You can open this report (in .xlsx format) from the **History browser**. The log file is used for troubleshooting and support.

Continues on next page

Allow Execution State Running

You can not execute a job when the controller's program execution is in the *Running* state. This precaution is to avoid production getting disturbed when robots are performing sensitive path following applications such as laser cutting or arc welding. Jobs such as backup or search RAPID data can put load on the controller. Select the **Allow Execution State Running** check box available in the **Device Selection** area while executing these jobs.

Supported actions

Using the Jobs feature you can perform the following actions on a group of robot controllers. You must select the required action in the **Selected Action** list in the **Jobs** window. Some of these actions require the following additional data.

Action	Description
Backup	<ul style="list-style-type: none"> Backup Path: User-defined destination folder for saving the backup file, this file contains controller specific backup folders with a date and time stamp in the format Backup_{Date}_{Time}. Backup name: The name of the backup file in the format {SystemName}_{Date}. The name template can be modified according to the user needs. The strings in curly brackets will be replaced by the current values. <p> Note</p> <p>The complete list of options to use for creating the file and folder names are {NetworkAddress}, {ControllerName}, {SystemName}, {SerialNumber}, {Comments}, {Group}, {Date} and {Time}.</p>
Backup Program Modules	Creates backup of program modules with a date and time stamp in the format Backup_{Date}_{Time}. You can specify the name and destination folder of the backup program module in the Backup name and Backup Path fields.
Update UAS	<ul style="list-style-type: none"> UAS File: User-selected UAS file. UAS File Password: Password of the UAS file. For more details about creating a UAS file, see User Accounts on page 423.
Set Time	Threshold (seconds): User-defined threshold time in seconds. The threshold defines the allowed time difference.
Verify Time	Reads the time for each controller and compares it with the local PC time.
Set Time Server and Time Zone	Select this action to set the time zone of the NTP server. Enter the name of the server in the NTP Server box and select the required time zone in the Time Zone list.
Save Event Logs	Reads the specified event logs and saves it to the specified location on the PC.
Search Event Logs	Searches the event logs for a specified type (All, Warnings and Errors, Errors) and upto an optional time(in days). You can also specify the range for the error codes to include in the search.

Continues on next page

11 Controller tab

11.3.14 Jobs

Continued

Action	Description
Read Single Data	<p>You can read RAPID Data, I/O Signal values, Configuration parameters and device information with this function.</p> <ul style="list-style-type: none">For RAPID Data, you must specify the URL of the RAPID instance as <i>Task/Module/Data</i> or only <i>Task/Data</i>, for example, <i>T_ROB1/Module1/myToolData</i>, or <i>T_ROB1/myToolData</i>. The result will be the value of the instance.For I/O Signals, you must specify the name of the signal, for example, <i>mySignal</i>. The result will be the signal value.For configuration parameters, you must specify the URL to the instance attribute in the form <i>DOMAIN/TYPE/InstanceName/AttributeName</i>, for example <i>MOC/ARM_LOAD/r1_load_4/mass</i> or <i>EIO/EIO_SIGNAL/diMySignal/access</i>.Select the Devices option, to read device information like <i>Main Computer Fan Speed</i>, <i>Main Computer Module Temperature</i>, <i>CPU Temperature</i> and <i>Free RAPID Memory(MB)</i> by selecting the required option in the Copy From the device browser. <p>To read other properties, copy the device property ID from the Device Browser. Right-click the desired property and select Copy device property ID from the context menu. Paste the ID into the text field above.</p> <p>See the Technical reference manual - System parameters for the names of the domains, types and attributes. The result will be the value of the attribute.</p>
Search RAPID Data	Searches for RAPID instances that matches the specified search patterns. You can restrict the search to tasks, modules, data types and names of record fields that match the specified pattern.
Search RAPID Text	Searches for lines that contain the specified text string. You can restrict the search to tasks or modules that match a certain name pattern.
Write File or Directory	Writes the selected file or directory to the specified target directory.
Read File or Directory	Reads the selected file or directory from HOME folder or from a task.
System Information	Reads the options, languages and media versions of the controllers.
Run External Tool	<p>Invokes an external executable.</p> <ul style="list-style-type: none">External Tool Path: Location of the folder where the external tool is placed.Arguments: User specified arguments which the external tool passes, for example {SystemName}, { Network address},{Group} and so on.Timeout(s): Specifies command time out period.
Compare Folder	Compares two folders and generates a report with the differences. These reports are available in two formats, Excel and xml files. These reports are not exclusive to Compare Folder.
Save System Diagnostics	Reads the System Diagnostics file and saves it to the specified location on the PC.
Save Assessment Data	Reads the Assessment Data and saves it to the specified location on the PC.

Jobs with several actions

You can use the **Add** button to create a job with several Actions. The **Remove** button will remove the selected Action. The execution order can be changed by the **Up** and **Down** buttons. There will be one sheet per Action in the resulting Excel report.

Continues on next page

The **Save** function, **Verify** and **Execute** are not specific to the multi-action Job.

Running job from the Command Prompt window

Use the following steps to run a job or a batch of jobs from the Command Prompt window.

Step	Action
1	Create a Job and save it with a suitable name, for example 'Job1'. For a default installation of RobotStudio, the job gets saved in C:\Users\ <user name="">\Documents\RobotStudio\JobTemplates folder as an *.xml file.</user>
2	Open Notepad and type in "C:\Program Files (x86)\ABB Industrial IT\Robotics IT\RobotStudio 6.xx\Bin\Addins\FleetManagement\runjob.exe" "C:\Users\ <user name="">\Documents\RobotStudio\JobTemplates\Job1.xml"/defaultcredentials. The example assumes that RobotStudio is installed in the default location. A specific user name and password can be supplied with the options /user:<user name> and /password:<password>.</user>
3	Save the *.txt file with the *.cmd extension.
4	Double-click the *.cmd file to run the job. Log files and reports get generated and is available in the Jobs browser .



Note

You can schedule jobs using the **Task Scheduler**.

11 Controller tab

11.4.1 Virtual FlexPendant

11.4 Features for virtual controllers

11.4.1 Virtual FlexPendant

Opening a Virtual FlexPendant

You can open a virtual FlexPendant in one of the following ways:

- 1 On the **Controller** tab, in the **Controller Tools** group, click the arrow next to the **FlexPendant** icon, and then click **Virtual FlexPendant**.
- 2 Press the keyboard shortcut, **CTRL + F5**.



Note

The Virtual FlexPendant is applicable while running a virtual controller. For information on specifying the appearance and placement of virtual FlexPendant, see [Options on page 217](#).



Note

RobotStudio does not support non-motion execution option. This option can be set to prevent the real controller from moving, even when, the program is executing. RobotStudio will ignore this option and move the robot. The non-motion execution option applies to virtual controllers only.

11.4.2 Control Panel

The Control Panel dialog box

Operation Mode	This group contains the three operational modes of the controller represented by option buttons.
Auto	This option corresponds to the Auto mode on the FlexPendant. Moving between the Auto and Manual Full Speed options must proceed via the Manual option.
Manual	This option corresponds to the Manual mode on the FlexPendant.
Manual Full Speed	This option corresponds to the Manual 100% mode on the FlexPendant. Moving between the Auto and Manual Full Speed options must proceed via the Manual option.
Motors On	Click this button to turn on the motors.
Enable Device	In a manual mode, click this button to simulate holding the three-position enabling device to turn on the motors.
Release Device	In a manual mode, click this button to turn off the motors.
Reset Emergency Stop	If the controller enters the emergency stop state, click this button to reset the state.

11 Controller tab

11.4.3 Shutdown

11.4.3 Shutdown

Shutting down a controller

- 1 In the **Controller** browser, select the controller to shut down.
- 2 Select the controller.
- 3 Follow these steps to shutdown a controller:
 - On the **Controller** tab, in **Controller Tools** group, click **Restart** and then click **Shutdown** to shutdown a virtual controller.
 - On the **Controller** tab, in **Controller Tools** group, click **Restart** and then click **Shutdown main computer** to shutdown a real controller.

11.4.4 Set Task Frames

Modifying Task frame

- 1 On the **Controller** tab, in the **Virtual Controller** group, click **Task Frames**. The **Modify Task Frames** dialog box appears.
- 2 Set the reference to **World**, **UCS**, or **Local**.
- 3 Edit the position and orientation of task frames in the **Task Frames** coordinate box.
- 4 Click **Apply**.

To the question, *Do you also want to move the Base Frames(s)?*

- Click **Yes** to move the base frame, but keeps its relative placement to the task frame.
- Click **No**. The following question appears **Do you want to update the controller configuration and restart?**. Click **Yes** to restart the controller and update the base frame configuration of the connected VC.



Note

If there are any stationary RAPID objects (tooldata, workobjects) connected to the robot, the following question appears **Do you want to keep the positioning of all stationary RAPID objects?**

- Click **Yes** to keep all the stationary RAPID objects in their global coordinates.
- Click **No** to move all the stationary RAPID objects along with the base frame (same coordinates relative to base frame).

11 Controller tab

11.4.5 Edit System

11.4.5 Edit System

Overview

The Edit System window contains functions for making and viewing advanced system configurations, such as changing controller and baseframe positions, calibrating and setting up external axes.

The left side of the Edit System window contains a hierarchical tree with which you browse to different aspects of the system. The right side contains a property sheet for the aspect selected in the tree. Below are short descriptions of the property sheets for each aspect node of the tool.



CAUTION

Editing the system may result in corrupted systems or unexpected robot behaviors. Be sure to understand the effects of the changes before proceeding.

The System node

The system node contains a box with information about the system and a button for loading new parameters (configuration files) to the system.

The task node

The task node has no property page.

The mechanism folder node

The property page of this node contains controls for mapping and setting axis and joints. It is from this page you set up external axes.

The mechanism library node

The property page of this node contains controls for changing the baseframe of the robot or mechanism. Here, too, you specify whether the baseframe is moved by another mechanism (coordinated motion), like a track external axis.

Updating the baseframe position

- 1 Move the mechanical unit (robot or external axis) to its new location using the ordinary tools for moving and placing objects.
- 2 In the **Controller** browser, select the controller for the mechanical unit.
- 3 On the **Controller** tab, in the **Virtual Controller** group, click **Edit System**. This opens the **System Configuration** dialog.
- 4 Select the node for the mechanical unit in the hierarchical tree. The baseframe property sheet for the robot is now displayed.
- 5 Select the baseframe position values to use after restarting the robot.

Select	To
Controller values	Reset all changes to the baseframe made since the last time the system was started.

Continues on next page

Select	To
Stored station values	Reset all changes made to the baseframe since the last time the station was saved. Optionally, you can enter new values in the baseframe coordinate boxes (relative to the controller world coordinate system).
Use current station values	Read and use the current location of the baseframe. Optionally, you can enter new values in the baseframe coordinate boxes (relative to the controller world coordinate system).

6 Click OK.



Note

For information on adding a track from the Edit System tool, see [Track motion of type RTT or IRBTx003 on page 88](#).

Calibrating the baseframe position

The positioner mechanism is placed according to the base frame values of the virtual controller. When a virtual controller is created from backup, in which, the positioner was calibrated online using four points method, and if the positioner was not in its sync position at the first calibration point, then the positioner mechanism will not be aligned with the system's task frame .

You can calibrate base frame values to realign the positioner mechanism with the system's task frame.

- 1 In the controller tab, click **Edit System**. The **System Configuration** dialog opens.
- 2 In the **System Configuration** window, select the positioner mechanism and then click **Calibrate**.
The **Base Frame Calibration Position** dialog opens.
- 3 From the **System Configuration** dialog, copy the **Orientation** values under **Base Frame** and paste these values in the boxes under **Orientation** in the **Base Frame Calibration Position** dialog.
- 4 Click **Apply** and then click **OK**. You must restart the controller when prompted. The positioner mechanism will be aligned with the system's task frame now. Any object attached to the positioner will take the orientation of the positioner.

This page is intentionally left blank

12 RAPID tab

12.1 Overview of the RAPID tab

The RAPID tab provides tools and functionalities for creating, editing, and managing RAPID programs. You can manage RAPID programs which are online on a real controller, offline on a virtual controller, or standalone programs which are not part of a system.

12.2 Synchronize to Station

Synchronizing to the station

- 1 On the **RAPID** tab, in the **Access** group, click the arrow next to the **Synchronize** icon, and then click **Synchronize to Station**.
- 2 Select the paths to be synchronized to the station from the list.
- 3 Click **OK**.

The message **Synchronization to Station completed** is displayed in the Output window.

RAPID can be synchronized from the files of the HOME folder as an alternative:

- In the **Controller** browser, under **Home** folder, right-click any file and then click **Synchronize to Station** to synchronize data and procedures of the selected file into the station.
- In the **Controller** browser, under **Home** folder, right-click any file and then click **Synchronize to File** to synchronize data and procedures from the station into the selected file.

Before selecting this option, you must synchronize the selected file to the station. Using the **Synchronize to File** option can conflict with the **synchronize to RAPID** option.

Limitations

- Robtargets that are local to a procedure are not supported by **Synchronize to Station**. Only robtargets that are local to a module are supported.
- RobotStudio does not fully support instructions using *Offs* or *RelTool* functions. These are synchronized and will appear in the element browser, but commands such as *View Tool at Target* and *Locate Target* will not work. Targets used in the instructions will not be visible in graphics. However, instructions can be programmed and edited using the RAPID Editor and can be simulated using the virtual controller.
- RobotStudio does not support RAPID programs containing arrays of tooldata, robtargets and workobjects. These programs will not be synchronized to the station.
- Workobjects and tooldata that are shared between several tasks must be specified in RAPID with its full value for each task when programming offline with RobotStudio. This will trigger a warning *Initial value for PERS not updated* in the controller event log. You may ignore this warning. However, you must carefully ensure that the RAPID variable definitions are the same in all tasks, otherwise you may get unexpected behavior.

12.3 Synchronize to RAPID

Synchronizing to RAPID

- 1 On the **RAPID** tab, in the **Access** group, click the arrow next to the **Synchronize** icon, and then click **Synchronize to RAPID**.
- 2 Select the elements to be synchronized from the list.
- 3 Click **OK**.

The message **Synchronization to RAPID completed** is displayed in the Output window.



Note

This function is also present in the **Controller** group on the **Home** tab.

12.4 Edit RAPID code

Editing RAPID code using RAPID Editor

The RAPID editor enables you to view and edit programs loaded into a controller, both real and virtual. The integrated RAPID editor is useful for editing all robot tasks other than robot motion. With the RAPID editor you can edit the RAPID code of the program modules and system modules. Each module you open appears in an editor window of its own, where you can add or edit RAPID code.

For examples of using the RAPID editor, see [Examples of using the RAPID editor on page 475](#).

General RAPID Editor features

The following are the general features of the RAPID Editor:

- **Read-only documents** - If the document is read-only (for example, due to lack of mastership), then the background of the editor area will be light gray instead of the normal white. Typing in an editor that is in the read-only state results in a dialog asking you whether RobotStudio should acquire write access.
- **Syntax highlighting** - Text is highlighted in different colors depending on their token classification (such as keyword, identifier and so on). You can configure these colors in the *File* tab, under *Options:Robotics:RAPID Editor*. For more information, see [Options:Robotics:Text Editor on page 220](#).

In addition to token classification, the editor also shows different colors for built-in and installed identifiers (such as MoveL) and also for identifiers declared in user code.

- **Quick-Info tooltips** - When you hover the mouse pointer over a symbol (such as a data declaration or procedure call), a tooltip is displayed describing the symbol. For many built-in symbols (such as MoveJ) a short description is also displayed. For symbols corresponding to a data declaration, the current value is also displayed.
- **Context-sensitive help** - Pressing F1 when the cursor is on a RAPID programming construct, such as an instruction, opens the related section in the RAPID reference manual, instead of the main RobotStudio help.
- **Auto-indent cursor on return** - When you press Enter, the cursor is automatically indented by the appropriate amount on the following line. For example, after typing a PROC header, pressing ENTER will indent the cursor one tab (or the corresponding number of spaces, depending on settings).
- **Completion list** - When you type in code in the editor, a pop-menu which lists possible code suggestion maybe displayed depending on the kind of RAPID code construct being written. The suggestions listed also depend on where in the document the cursor is.

Pressing comma (,), semi-colon (;), colon (:), equal sign (=), Spacebar, Tab, or Enter keys automatically inserts the selected item. Press Esc to cancel the list.

Continues on next page

- **Auto-completion** - After typing or completing a procedure call (such as MoveJ), pressing the Tab key will fill in all required parameters. Note that this is only available for certain built-in procedures, such as those listed in the *Insert Instruction* menu.
- **Argument information** - While typing in procedure calls and function calls, tooltips showing argument information are displayed.
- **Collapsible regions** - All regions of the code can be collapsed. In the **RAPID** tab, click **Outlining** to access this functionality. You can either collapse or expand all regions or can select a particular region to collapse or expand.
- **Error highlighting** - Red squiggly lines appear under errors in the code. All syntax errors and a subset of semantic errors are indicated in this manner.
- **Zooming in and out** - In the RAPID editor you can zoom in and zoom out of the code display. Click the plus (+) and minus (-) buttons at the top right corner of the RAPID editor window to zoom in and zoom out.

**Tip**

The Zoom in Zoom out feature is also present in the *RAPID Tasks, Rapid Editor, Configuration Editor, Event viewer, and I/O* windows.

- **Cut, copy, paste and drag and drop** - These standard commands for clipboard handling of text are supported.
- **Undo and redo** - Standard commands for undo and redo operations are supported.
- **Selection modes** - You can select text by character, row and column.
- **Line numbers** - Line numbers for the RAPID code lines are displayed in the left margin of the editor.
- **Keyboard shortcuts** - For keyboard shortcuts in the RAPID Editor, see [Keyboard shortcuts on page 76](#).
- **RAPID compare**- To compare the controller version of RAPID module with the editor/file version, right-click an open module and then click **Editor Version** or **File**. You can compare folders and files using the **Compare** button. In the **Find** group, click **Compare** and then select the required comparison options like **Controller Version and Editor, Controller Version and File and Editor and File**.

You can configure the comparison results either to show *all content* with the differences highlighted or with *only the differences* between files/folders. Select **Options** like **BackInfo, PERS variables, Comments, Character case and White space** to add filters. The **BackInfo** option excludes the timestamp of the *Backinfo.txt* file from comparison.

Starting the RAPID Editor

To open a RAPID module in the RAPID editor, in the **Controller** browser right-click on a RAPID module, and then click **RAPID Editor**.

Continues on next page

12 RAPID tab

12.4 Edit RAPID code

Continued

The RAPID code of the module opens in the editor window.



Tip

You can view the graphical layout, without closing the editor, by clicking the graphics window tab.

Editing a RAPID program

The Edit group on the RAPID tab has commands which help in editing the lines of code in the RAPID Editor. Other than standard functions such as Cut, Copy, and Paste, the following functions are present in the Edit group:

- Comment – To comment out selected lines
Uncomment – To uncomment commented lines
The comment and uncomment buttons in the ribbon will add/remove comment characters (“!”) at the beginning of the selected line(s).
- Indent – To increase the indent of selected line(s) by four white spaces
Unindent – To decrease the indent of selected line(s) by four white spaces
The indent and unindent buttons in the ribbon will move the selected code line(s) one tab position to the right/left.
- Format Document - Auto-formats the active document by arranging the spaces and tabs in the RAPID code.
- Uppercase Keywords - To change RAPID keywords from lowercase to uppercase. This function operates on the current document.
- Format Selection – This function is similar to Format Document, but with the difference that it operates on currently selected text.
- Convert Spaces to Tabs - Converts consecutive spaces to the corresponding number of tabs. This function operates on the current selection.
- Convert Tabs to Spaces - Does the opposite of function above.



Note

To make formatting easier, the tabs and white spaces can be indicated by arrows and dots, respectively. To enable this go to Options:Robotics:RAPID Editor ([Options:Robotics:Text Editor on page 220](#)) and then select the **Show whitespace** check box.

By default a Tab consists of four whitespaces. To change this, go to Options:Robotics:RAPID Editor and set the Tab size as your require.

- Modify Position - Updates the coordinates of the target used in the move instruction to the current position of the robot.

Edited lines are denoted by change bars which remain until the edits are applied. Also, the RAPID Editor's tab sports an asterisk (*) until the edits are applied.

Continues on next page

Adding code snippets

Code Snippets are pieces of code which you can insert into the RAPID Editor. To view and select a code snippet, in the Insert group, click Snippet.

The list which appears show two kinds of code snippets:

- Predefined code snippets
- User defined code snippets

The following are the predefined code snippets in RobotStudio:

- Array of num, 2x2x4
- Array of num, 2x4
- Array of num, 2x4x2
- Array of num, 4x2
- Module header
- Procedure with parameters
- Procedure with error handler
- Robtarget declaration
- Tooldata declaration
- Workobject declaration

You can also create your own code snippets or save a section of existing code from the RAPID editor as a code snippet. Such user created code snippets are also listed along with the predefined snippets.

To save a section of existing code, from the RAPID editor, as a code snippet:

- 1 Select the code you wish to save as a snippet.
- 2 In the **Insert** group, click the arrow next to the **Snippet** icon, and then click **Save Selection as Snippet**.

The *Save As* dialog box appears. Specify a name for the snippet and save it. The RobotStudio .snippet files are saved in the following folder.

C:\<Documents and Settings>\<user name>\RobotStudio\Code Snippets

To insert a snippet in the RAPID editor, click the arrow next to the **Snippet** icon, and then click the required snippet from the listed snippets.



Note

The folder *<Documents and Settings>* may be configured with different names, for example, *Data*. It may also be translated on localized versions of Windows. Snippets can also be edited in an XML editor such as Microsoft Visual Studio. For information on creating customized code snippets, see <http://msdn.microsoft.com/>.

Inserting instructions

To insert a predefined instruction into the code:

- 1 Place the cursor at the required point in the RAPID code.
- 2 In the **Insert** group, click **Instruction**.

A list of pre-defined instructions is shown.

Continues on next page

12 RAPID tab

12.4 Edit RAPID code

Continued

The instruction is inserted into the code where the cursor is placed. RobotStudio generates and inserts default arguments to the instruction, using similar rules as the FlexPendant.

Applying and verifying the edits

To apply the changes made in the editor to the system and also to check the program go to the Controller group, and click the arrow next to the Apply icon. Then:

- To apply only the changes in made in the module, currently shown in the editor, click **Apply Changes**.

Alternatively, you can also directly click the Apply icon

- To apply the changes made in all modified modules, click **Apply All**.



Note

The Apply commands are enabled only if there are changes waiting to be applied. When possible, RobotStudio will try to commit the changes without losing the program pointer. If this is not possible, you will be asked if it is OK to lose the program pointer.

To verify the syntactic and semantic correctness of the modules, in the **Test and Debug** group, click **Check Program**.

12.5 Find and replace RAPID code

Overview

The Find group, on the RAPID tab contains commands for performing Find and Replace actions on the code in the RAPID editor.

Quick Find

Enter the search string in the **Quick find** box and then press Enter or F3. If an instance is found, it is highlighted. Press F3 again to search for the next instance.

Go to line

Enter a line number in the **Go to line** box and press Enter. The cursor moves to the corresponding line in the RAPID editor. When multiple tasks are open in the editor, and if you select the procedure name in the list box, the cursor moves to the task that contains the specified name.

Jump To

The Jump To list has an item for each routine and data declaration in the program module. Click an item to move to its location in the code.

Find or Replace

Click **Find/Replace** to open the **Find/Replace** dialog. This dialog provides standard find/replace functionality and the following options.

- Enter the string to search in the **Find what** list.
- In the **Look in** list, select the option to specify the location to look for. The various options are **Current Document**, **Current System**, **Current Task**, or a folder in your PC (you can browse to a folder to specify it).

The **Search Results** window displays the results of the find operation. Double-click a search result to go to the corresponding instance in the RAPID editor. If the instance is from a module which is not in the RAPID editor, then the module opens in the editor.

Go To Definition

The **Go To Definition** command is enabled for an identifier in the RAPID Editor context menu if the source code for the corresponding symbol definition is available. Click **Go To Definition** to move the cursor to (and select) the corresponding symbol definition. This action detects symbol definitions such as routine declarations, data declarations and record definitions.

Navigate forward/backward

Use the **Navigate Backward** button to move to previous locations of the RAPID modules being edited, and the **Navigate Forward** button to return to more recent locations.

Continues on next page

12 RAPID tab

12.5 Find and replace RAPID code

Continued

Find Unused References

Click **Find unused references in Task** to see all data declarations in the task of the active module document that are not used anywhere. The results are shown in the *Search Results* window. Click **Find unused references in Module** to see unused data declarations in the current module.

Find All References

The **Find All References** command is enabled for identifiers in the editor code.

For a given identifier, click **Find All References** to search through the entire task for uses of the same identifier (including its definition). Note that this is not just a string search. It takes RAPID scoping rules into account. For PERS and syncident data, this function searches the other tasks for a matching global symbol and return the uses of those.

12.6 Manage RAPID modules

Managing file based RAPID modules

File based RAPID modules can be opened in the editor in four different ways:

- Using the *Open* command on the File tab
- Using the *New:RAPID Module File* command on the File tab. For more information, see [Creating a new RAPID module file on page 212](#).
- Double-clicking a module in the File browser of the RAPID tab. For more information on the File browser, see [Manage RAPID files and backups on page 458](#).
- Right-clicking the Files nodes and selecting **Open** in the File browser of the RAPID tab. For more information on the File browser, see [Manage RAPID files and backups on page 458](#).



Tip

For file based modules, the standard file commands are applicable: **Save/Save As** will save the module; **Open** will open a module and **Close** will close the module.

The **Apply Changes** command is disabled for file based modules. It is applicable only for controller based modules.

Creating a new RAPID module

- 1 On **RAPID** tab, in the **Controller** browser, right-click a task and then click **New Module**.
The Create Module dialog box opens.
- 2 Enter a module name.
- 3 Select the **Module type** as Program or System, as required.
- 4 Select one of the following options:
 - No Step-In - The module cannot be entered during step-wise execution.
 - Read-only - The module cannot be modified.
 - View-only - the module cannot be modified, but the attribute can be removed.
- 5 Click **Create**.

Loading a RAPID module

You can load a RAPID module either from the system or from the controller disk.

- 1 On **RAPID** tab, in the **Controller** browser, right-click a task and then click **Load Module** to load a module from the system or click **Load Module from Controller** to load a module from the controller disk.
- 2 Browse to and select the module to be loaded to your station, and then click **Open**.

Continues on next page

12 RAPID tab

12.6 Manage RAPID modules

Continued

Saving a RAPID module

You can save a RAPID module either in the system or in the controller disk.

- 1 On **RAPID** tab, in the **Controller** browser, right-click a module and then click **Save Module As** to save the module in the system and click **Save Module to Controller** to save the module in the controller disk.
- 2 Browse to the location where the new module is to be saved and then click **Save**.

12.7 Edit RAPID data

RAPID Data Editor overview

The RAPID Data Editor allows you direct access to RAPID data values, which you can view and edit.

To open the RAPID Data Editor, on the **RAPID** tab go to the **Controller** browser, right-click a RAPID module, and then click **RAPID Data Editor**. This opens the Data window which shows the data declarations in that particular module.

Data declarations are grouped according to their data types. All data declarations belonging to a data type are shown in a table below it. Each row corresponds to a data declaration and shows the contents of the declaration.

Using the RAPID Data Editor

- Editing the values of a row opens the changed value in the RAPID Editor window. The new value is shown in both the Data editor and also the RAPID editor. This means that the changes made in the RAPID data editor are seen in the RAPID editor, and vice-versa.



Tip

An asterisk (*) on the window tab indicates unsaved changes.

- You can select multiple cells and edit them together.
- You can create, edit or delete a data declaration from the RAPID Data Editor.
- To delete a data declaration, select the row and click the **Delete** button beside it.
- To add a new declaration, click **New Declaration** next to the required data type. This adds a new row to the table below it having some default properties and values, which can be edited. However, you cannot add a data type declaration that is not already present in the module. In such cases, you must add the declaration manually to the module using the RAPID Editor.
- To view the orientation of robtargets in angles, select the **Show quaternions as RPY angles** checkbox in the RAPID Data Editor. Orientations can be represented in angles and quaternions, set the default representation in the RobotStudio Options.



Note

The RAPID Data Editor only shows data declarations that contain editable values.

12.8 Manage RAPID files and backups

Managing RAPID files

- 1 In the Files browser, right-click the **File** node and then click **Open**. The **Open File** dialog box appears, browse and open system module (*.sys), RAPID modules (*.mod), and Configuration files (*.cfg) which resides on your PC or on a network.



Note

The content of the *HOME* folder of the connected virtual or real controller is visible in the **Controller** browser. Both RAPID and configuration files can be edited as text files.

For virtual controllers, RAPID modules can be synchronized to the graphics environment of the station using the context menu of the RAPID module file. To synchronize any changes back to the RAPID module, use the command **Synchronize to file**.

- 2 A RAPID or system module file opens in the RAPID editor. The system parameters file (*.cfg) opens in a notepad-like editor.
- 3 Click the **Save** button on the Quick Access Toolbar to save the changes.



Note

When you open standalone RAPID modules, the editor may show the code as having syntax errors if the variable declarations exist in another module.

Managing system backups

Right-click **Backup** and click **Browse**, to select and open system backups.

The structure of the backup is reflected in the **Files browser** under the **Backups** node. There is one node for each task defined in the system. The RAPID modules of each task are shown as its child nodes in the tree view. The editor will find data declared in other modules and correctly mark the code as being syntactically and semantically correct.

The contents of the *HOME* folder are shown in a separate folder. RAPID modules of the *HOME* folder will be edited in the standalone mode, which means that the editor will not find data declared in other modules. The reason is that the editor cannot know in which context (task) the module should be treated.

The *SYSPAR* folder will show the configuration files.



Note

There is no syntax check or intellisense for editing configuration files.

12.9 Manage RAPID code on the controller

12.9.1 Manage RAPID programs

Loading a RAPID program

You can load a RAPID program either from the system or from the controller disk to a station:

- 1 On the RAPID tab, in the **Controller** group, click **Program** icon and then select **Load Program** to load a RAPID program from the system and select **Load Program from Controller** to load a RAPID program from the controller. Alternatively, in the Controller browser, right-click the active task under the station, and click **Load Program**.
- 2 In the **Open** dialog box that appears, browse to the location of the program to be loaded to your station and click **Open**.

Saving a program

You can save a RAPID program either in the system or in the controller disk.

- 1 On the RAPID tab, in the **Controller** group, click **Program** icon and then click **Save Program As** to save the RAPID program in the system and click **Save Program to Controller** to save a program in the controller disk. Alternatively, in the Controller browser, right-click the active task under the station, and select **Save Program As**.
- 2 In the **Save As** dialog box that appears, browse to the location where you want to save your program, and click **Save**.

Renaming a program

- 1 On the RAPID tab, in the **Controller** group, click **Program** icon and then click **Rename Program**. Alternatively, in the Controller browser, right-click the active task under the station, and select **Rename Program**.
- 2 In the **Rename** dialog box that appears, enter a new name for your program, and click **Ok**.

Deleting a program

- 1 On the **RAPID** tab, in the **Controller** group, click **Program** and select **Delete Program**.
A confirmation dialog is displayed.
- 2 Click **Yes**.
The selected program is deleted.

To delete the entire program under a task in a station, in the **Controller** group, click **Program** and then click **Delete Program**.

Alternatively, in the Controller browser, right-click the task under the station, and then click **Delete Program**.

12 RAPID tab

12.9.2 RAPID Tasks

12.9.2 RAPID Tasks

Overview

The RAPID Tasks window shows the configured tasks of the selected controller and their state, in a tabular form. To open the RAPID Tasks window, in the **Controller** group click **RAPID Tasks**.

The following table describes the columns displayed for each task.

Task Name	The task name, as defined by the controller configuration in topic Controller, type Task. For information on topic Controller type Task, see the <i>Technical Reference Manual for System Parameters</i> .
Type	A task can be of type Normal, Static, or SemiStatic. This is defined by the controller configuration in topic Controller, type Task. For information on topic Controller type Task, see the <i>Technical Reference Manual for System Parameters</i> .
Mechanical Unit	Shows which mechanical unit group is used for the task. This is defined by the controller configuration in topic Controller, type Task For information on topic Controller type Task, see the <i>Technical Reference Manual for System Parameters</i> .
Run Mode	Defined by the Run Mode setting in RobotStudio. For more information on Run Mode, see Run mode of the controller on page 463 .
State	Displays the task execution state. A task can be in state Ready, Running, or Stopped. <ul style="list-style-type: none">• Ready: The program has no PP (program pointer). To set the program pointer, use the Program Pointer menu of the RAPID Tab. Alternatively, use the FlexPendant.• Running: The program is running.• Stopped: The program has stopped. For more information on the Program Pointer (PP), see Using the Program Pointer on page 468 .
TrustLevel	Handles the system behavior when a SemiStatic or Static task is stopped or not executable. The possible values here are NoSafety, SysFail, SysHalt or SysStop. A SemiStatic or Static task can only be stopped if it has TrustLevel as NoSafety. The TrustLevel is defined by the controller configuration in topic Controller, type Task. For information on topic Controller type Task, see the <i>Technical Reference Manual for System Parameters</i> .
Program Name	The name of the program in the specific task.
Module Name	The current module name.
Routine Name	The current routine name.
Task in Foreground	Use this to set priorities between tasks. The current task will execute only if the foreground task is idle. This is defined by the controller configuration in topic Controller, type Task.

Continues on next page

Task execution state

A task can be activated, started, and stopped from the Controller browser, with the following limitations:

- Only Normal tasks can be activated and deactivated. Background tasks will always be automatically activated.
- Background tasks of type Static and SemiStatic can only be started and stopped if they have TrustLevel NoSafety.

For detailed information about the different TrustLevel values, see the *Technical reference manual - system parameters*.

- You need to have write access and the appropriate grant.
- The limitations concerning task execution that hold for the FlexPendant also apply to RobotStudio.

The following table shows cases where task execution state cannot be changed.

If...	RobotStudio gives a message that informs the user that...
the user does not have the grant <i>Execute program</i> or <i>Full access</i>	the operation is not possible.
the user changes from manual mode to automatic mode, or vice versa, the user loses the write access and	the operation is not possible.
the motors are in off state	the Start operation is not possible.



Note

It is not possible to override the controller's safety system, that is, you cannot stop a background task (Static and SemiStatic) that has the TrustLevel set to a value other than NoSafety.

For detailed information about the different TrustLevel values, see *Technical reference manual - system parameters*.

Activating, starting and stopping tasks

To activate a task, right-click the task in the Controller browser and then turn on the **Active** command.

If the prerequisites are met, you can operate the task, such as start and stop the task, move the program pointer to main and set the run mode.

To start a task, right-click the task in the Controller browser and then click **Start Task**. You can start Normal tasks, but you can only start a Static or SemiStatic task if the TrustLevel is set to NoSafety.



CAUTION

When starting a task, the manipulator axes may move very quickly and sometimes in unexpected ways! Make sure no personnel is near the manipulator arm!

Continues on next page

12 RAPID tab

12.9.2 RAPID Tasks

Continued

To stop a task, right-click the task in the Controller browser and then click **Stop Task**. You can stop Normal tasks, but you can only stop a Static or SemiStatic task if the TrustLevel is set to NoSafety.

12.9.3 Run Mode

Run mode of the controller

The Run Mode indicates the mode of the controller. It has the following two options:

- Continuous
- Single

You can set the run mode of the controller in the following ways:

- On the **RAPID** tab, in the **Controller** group, click **Run Mode** and then click either **Continuous** or **Single**.
- This method is only applicable to virtual controllers in a station.

On the **Simulation** tab, in the **Configure** group, click **Simulation Setup** and then select **Continuous** or **Single** in the **Setup Simulation** dialog box.

12.9.4 Adjust Robtargets

Overview

The Adjust Robtargets feature helps in recalculating and changing the robtarget data (tooldata and workobject data) while maintaining the joint angles of the robot. The robtarget data related to the specified source tooldata and workobject will be adjusted for usage with the new tooldata and workobject. In the **RAPID** tab, in the **Controller** group, click **Adjust Robtargets** to access this feature.

Prerequisites

- You should have a controller (virtual or real) running with one or more modules containing procedures with a sequence of move instructions expressed with a defined tool and workobject.
- You should have RobotStudio Premium license to use this feature.
- The **Execute** button of the feature Adjust Robtargets will be enabled only if the selected tool data or workobject data have the same properties, such as robhold, ufprog, ufmech and so on.



Note

Arrays, event records, and offsets are not supported. Relative tool is also not supported. Circular move instruction (MoveC) is supported.

Using Adjust Robtargets



Note

Take a backup copy of your modules before adjusting your robtargets.

The following procedure describes the Adjust Robtargets feature in RobotStudio:

- 1 On the **RAPID** tab, in the **Controller** browser, select a RAPID task or module under the RAPID icon. Then click **Adjust Robtargets** on the **RAPID** tab.

Alternatively, right-click the RAPID task or module in the **Controller** browser, and then click **Adjust Robtargets** in the context menu.

The Robtarget Adjust dialog box appears.



Note

You can access **Adjust Robtargets** from the **Controller** tab also. Right-click the RAPID task or module in the **Controller** browser and then click **Adjust Robtargets** in the context menu.

- 2 If the module you want to adjust is selected, then go to Step 4. Otherwise continue with the next step.

Continues on next page

- 3 Select a task from the **Task** drop-down list and module from the **Module** drop-down list.

**Note**

In the **Module** drop-down list, you can either select a particular module or **<ALL>** to update.

- 4 Select the source robtarget data (that is, the data defined in the selected task) from **Old tooldata** and **Old wobjdata** drop-down list.
- 5 Select the destination robtarget data (that is, new tooldata and workobject) from **New tooldata** and **New wobjdata** drop-down list.
- 6 Click **Execute**.

The **Execute** button is enabled only if source robtarget data (that is, old tooldata and workobject) and destination robtarget data (that is, new tooldata and workobject) are different.

The module searches for move instructions that use the specified old tooldata or workobject and recalculates the robtarget data for the new tooldata and workobject.

For example,

- 1 Select "tool0" as the source tool and "wobj0" as the source workobject.
- 2 Select "toolb" as the new tool and "wobjb" as the new workobject.
- 3 Click **Execute**.

Robtargets of "tool0" and "wobj0" will be replaced with re-calculated robtargets which correspond to the same robot configuration (all joint angles will be the same), and with the new tool "toolb" and "wobjb". Note that both the tooldata and the wobjdata are replaced independently.

Update instruction

By default, the **Update instruction** check box is selected. This means that move instructions using the specified source (old) tooldata and workobject will be updated to use the target (new) tooldata and workobject in addition to recalculating the robtargets.

If the **Update instruction** check box is cleared, the robtargets will be recalculated, but the move instructions will not be updated. They will still use the source tooldata and workobject.

This feature is useful after the calibration of tooldata and workobject. After calibration, you might still want to use the old names of the tooldata and workobject, but update their values and recalculate the robtargets accordingly. The following sample procedure illustrates how this can be accomplished.

Sample procedure

Prerequisite: RAPID module with robtargets and move instructions that use uncalibrated tooldata tool1, and workobject wobj1.

- 1 Calibrate your tooldata tool1, and workobject wobj1. Store the new values in tool1_calib and wobj1_calib, respectively. Keep the old values of the

Continues on next page

12 RAPID tab

12.9.4 Adjust Robtargets

Continued

uncalibrated tooldata and workobject in tool1, and wobj1. An error message gets displayed for an invalid selection of tooldata or workobject data.

- 2 Open the Adjust robtargets tool and clear the **Update instruction** check box. Select your RAPID module, enter tool1, and wobj1 as your old tooldata and wobjdata, and tool1_calib, and wobj1_calib as the new tooldata and wobjdata, respectively.
- 3 Click **Execute**, and apply the changes to the controller from the RAPID Editor
- 4 In the RAPID Editor, rename your tooldata tool1 to tool1_uncalib, and tool1_calib to tool1 and apply the changes to the controller. Also, perform the same for wobj1.

Now, your robtargets are updated to match the calibrated values of tool1 and wobj1.

Limitations

- If a robtarget is used more than once but with different tools or workobjects, then a message *Target is referenced* is displayed in the output window.
- The adjust robtargets function operates on a module level and does not update any referenced targets defined in other modules. It ignores the scope of the robtargets when the referenced targets are local to a procedure. In this case, any targets with the same name in the module scope will also be updated.
- Adjust Robtargets function works for modules with semantic errors, the editor excludes the particular line containing the error and continues with program execution. But Syntax errors stop program execution.

12.10 Test and debug

12.10.1 Commands for testing and debugging

Test and debug group

The Test and Debug group on the RAPID tab consists of the following commands.

Command	Description
Start	Starts the execution of all normal RAPID tasks in the system.
Stop	Stops the execution of all normal RAPID tasks in the system. The Stop All Selected command stops the execution of all selected tasks.
Step over	Starts and executes one statement in all normal tasks in the system.
Step in	Starts and executes into a routine, while stopping at the beginning of the routine.
Step out	Executes all remaining statements of the current routine, and stops after the call to the current routine.
Breakpoint : Ignore breakpoints	Ignores all breakpoints during simulation.
Breakpoint : Toggle breakpoint	Toggles a breakpoint at the cursor.
Check Program	Verifies the syntactic and semantic correctness of the RAPID modules.

Other tools such as the Program Pointer (PP) and the RAPID Profiler, which aid in testing and debugging RAPID code, are explained in detail in the following sections.

Selected tasks

You can use this option to select a particular task from a set of tasks to be stopped in the Manual Operating mode.

In the **Controller** group, click the **Selected tasks** button to view the list of tasks. You can select the required foreground task(Normal) or background task (Semistatic/Static) from the list.

12.10.2 Using the Program Pointer

How the Program Pointer helps

During program execution, the Program Pointer (PP) points to the line of code that is currently executing.

The function **Follow Program Pointer** keeps the program pointer visible during program execution by automatically scrolling the RAPID editor window according to the movements of the program pointer. To enable the function, in the Test and Debug group on the RAPID tab, click the arrow next to the Program Pointer icon and then select **Follow Program Pointer**.



Note

While the program executes, you can see the program pointer jump across modules only if those modules are already open in the editor. Hence, you can decide in which modules you wish to follow the program pointer in, and keep them open.

The other commands in the Program Pointer menu are:

- **Go To Program Pointer** – To show the current location of the program pointer in the RAPID editor
- **Go To Motion Pointer** – To show the current location of the motion pointer in the RAPID editor
- To set the program pointer at a particular line code or code segment and then start program execution from that point, use the **Set Program Pointer** options. You can choose from the following options:
 - Set Program Pointer to Main in all tasks
 - Set Program Pointer to Cursor
 - Set Program Pointer to Routine

Maintaining the Program Pointer

The RAPID code can only be edited when the controller is not running, that is when it is in state Ready or Stopped. In Ready state the program pointer is not set, but in Stopped state the Program Pointer is set to a specific location of the program. For limited changes to the RAPID code of a controller in Stopped state, the current location of the program pointer can be maintained. After such an edit you can resume program execution from where it was without having to reset the program pointer.



Note

If the edit is too large for the program pointer to be maintained then a warning message is displayed to convey this.

The program pointer cannot be maintained, for example, when editing the line of code at which the program pointer is located. Editing that line of code results in

Continues on next page

resetting the program pointer. In effect, the program will start from the beginning when the controller is started after the edit.

**WARNING**

Starting program execution after the program pointer has been reset will cause the robot to move along the shortest path from its current location to the first point of the program.

12 RAPID tab

12.10.3 Using the RAPID Profiler

12.10.3 Using the RAPID Profiler

What's RAPID Profiler

The RAPID Profiler analyzes the execution times on procedure level, identifies critical procedures and reports these during the execution of RAPID code.

Prerequisites for using the RAPID Profiler

- You should have RobotStudio Premium license to use this feature.
- You should have a controller with one or more executable tasks running.
- When using the RAPID Profiler with a real controller, you require more than 25 MB of free controller disk space.



Note

The RAPID Profiler will automatically stop if either of the following controller events is generated by the controller. This is to avoid disturbing the robot operation.

- **20192, Disk memory low** (less than 25 MB free storage left)
 - **20179, Disk memory critically low** (less than 10 MB free storage left, program execution is stopped)
-

How to use the RAPID Profiler

To use the RAPID Profiler:

- 1 Set the Program Pointer at a desired point in the RAPID code from where you wish to start your analysis. For example, set the program pointer to Main in all tasks.
- 2 On the **RAPID** tab, in the **Test and Debug** group, click the arrow next to the **RAPID Profiler** icon and then click **Start**.
- 3 Start the simulation.
In the background the RAPID Spy feature logs the data about the program's execution.
- 4 After the program execution ends, click the arrow next to the **RAPID Profiler** icon and then click **Stop**.
- 5 On the **RAPID** tab, in the **Test and Debug** group, click the arrow next to the **RAPID Profiler** icon and then click **Analyze**.

The RAPID Profiler window appears, showing the results of the analysis.

Click **Export to Excel** to export the results to a Microsoft Excel spreadsheet file.

To view the log file of the analysis, click the arrow next to the **RAPID Profiler** icon and then click **Open log file**.

Execution of the Rapid Profiler based on RobotWare version

Depending on the RobotWare version, the RAPID Profiler is executed in one of the following methods:

- For controller systems with RobotWare versions prior to 5.14, the RAPID instructions *SpyStart* and *SpyStop* must be inserted at the RAPID execution

Continues on next page

start and end, respectively. When the program is run, a Spy log file is generated. You can open the file for analysis by the RAPID Profiler. Use the RAPID Profiler menu option *Browse for Spy log* to open the log file.

For more information about *Spy* instructions, see *Technical reference manual - RAPID Instructions, Functions and Data types*.

**Note**

When the RAPID Profiler is used to analyze a log file, there is no information about in which procedure the *SpyStart* command is executed. The triggering procedure defaults to *<SpyStart Procedure>*.

- For RobotWare version 5.14 or later, the log file can be generated automatically. Activate the RAPID Profiler and run the program of the controller. When the program execution stops, the results are presented to the user.

Limitations

- The Spy function, which produces the input to the RAPID Profiler, does not produce useful output for systems based for Continuous Application Platform (CAP), Arc and RW Cutting. This affects the RAPID Profiler that analyses the log that Spy function generates.
- The RAPID Spy function measures RAPID program execution time and not motion execution time. To make these two times coincide for the RAPID procedures, ensure that the last move instruction of all procedures is a stop point. Otherwise, the RAPID instruction execution time will be lower than the motion execution time. The reason being the program execution runs ahead of the motion execution unless the programmed point is a stop point. For more information on stop points, see *RAPID Reference Manual*.

12 RAPID tab

12.11 RAPID Breakpoints window

12.11 RAPID Breakpoints window

Overview

The RAPID Breakpoints window lists all current breakpoints for the connected controllers.

Using the RAPID Breakpoints window

This window displays the following details:

Column	Description
System	Name of the controller.
Task	Name of the RAPID task.
Module	Name of the RAPID module.
Line	Number of the line where breakpoint is applied.

The following actions can be performed:

- Double-click a row in the window to open the corresponding module in the editor.
- Select rows and then press the delete-key to delete the selected breakpoints.

12.12 RAPID Call Stack window

Overview

The RAPID Call Stack window displays the call stack for the selected task if the program is in stopped state.

Using the RAPID Call Stack window

This window displays the following details:

Column	Description
Task	Name of the RAPID task.
Module	Name of the RAPID module.
Routine	Name of the procedure.
Line	Number of the line that contains the routine.
Execution Level	This field can take values: NORMAL, STATIC and SEMISTATIC.

12.13 RAPID Watch window

Viewing variables and I/O signals

The RAPID Watch window displays the following details of selected variables and I/O signals during program execution.

Column	Description
Name	Displays variable name
Value	Displays variable value
Type	Displays type of datatype
Source	Displays system name

You can view and edit the RAPID data of the variables in the RAPID watch window, both during program execution and when the controller is stopped. However, you can only view, but not edit, I/O signals in the watch window.

To view a variable or I/O signal in the RAPID Watch window, you need to first add it to the window. In the RAPID editor, right-click the required variable or I/O signal, and then click **Add Watch**.

By default, during program execution the values of the variables are automatically refreshed in the watch window every 2 seconds. You can also manually refresh the values.

To enable or disable automatic refresh, in the context menu, select or clear the **Auto Refresh** command.

To do a manual refresh, in the context menu, click **Refresh** (keyboard shortcut F5).



Note

CONST variables cannot be edited.

On closing RobotStudio, the variables and signals added to the watch window are removed.

On the **RAPID Watch** window, right-click to display the following context menu:

Item	Used for
Copy	Copying the value
Paste	Pasting the copied value
Delete	Deleting the watch item
Select All	Selecting all the items
Clear All	Clearing all the variables and signals from the watch window
Refresh	Manually updating the values of the variables and signals
Auto Refresh	Automatically refreshing the values displayed in the watch window at regular intervals

12.14 Examples of using the RAPID editor

Overview

This section provides examples illustrating several useful functions of the RAPID editor including IntelliSense, code snippets and the watch window.

Editing

Assume that you wish to create an infinite loop whereby the controller receives commands from a line PLC. The controller communicates with the PLC using digital I/O signals, but you have forgotten the exact name of the function that reads an input signal.

- 1 Using code snippets, create a new procedure.
- 2 On the **Rapid** tab, in the **Insert** group, click **Instruction**.
A drop-down list of available instructions is displayed.
- 3 On the **Instruction** menu, point to **I/O**, and then click **DOutput**.
- 4 Press the spacebar to display the parameter information ToolTip. As you enter parameters, the ToolTip is updated, displaying the current argument in bold. The ToolTip is closed either by concluding the instruction with a semicolon (;), or by pressing **ESC**.



Tip

At any time you may press **CTRL + Spacebar** to complete what you have begun typing. This will either bring up a narrowed-down list of selectable parameters, or, if only one selection remains, will automatically complete your text.



Tip

After typing the name of an identifier or an instruction, press the **TAB** key to automatically fill in the default arguments or parameters. For instructions, the last used argument of each type will be used.

Searching

Assume that you have programmed targets and motion instructions and synchronized them to the controller. The number of targets is large, so you decide to distribute them among several modules.

You may have forgotten in which module your main procedure is found.

- 1 Press **CTRL + F** to bring up the **Find and Replace** dialog box.
- 2 In the **Find what** box, type "PROC main". Since no modules are open, in the **Look In** list, select **Current System**, and then click **Find All**.
The search result is displayed in the *Search Results* window.
- 3 Double-click the line matching your search to launch the RAPID editor.

Continues on next page

12 RAPID tab

12.14 Examples of using the RAPID editor

Continued

Adding breakpoints

Now that you have finished editing, you may want to test your loop and add some breakpoints.

- 1 Place the insertion on the new statement and press **F9** to set a breakpoint.
 - 2 Ensure that the **Ignore breakpoints** button in the editor toolbar is not clicked, and click the **Play** button on the **Simulation** toolbar.
The program will run and then stop at the breakpoint.
 - 3 To run the program statement by statement, click the **Step over** button in the editor toolbar.
-

Executing

You might want to debug your loop or monitor a specific variable.

- 1 In the RAPID editor browser, right-click the procedure you want to set as entry point, and then click **Set Program Pointer to Routine**.
- 2 In the **RAPID** tab, click the **Play** button.
The program will run and then stop at the next breakpoint.
- 3 Select a variable for monitoring and drag it to the watch window.
- 4 Restart the loop and monitor the variable at each iteration.

13 Add-Ins tab

Overview of the Add-Ins tab

The Add-Ins tab contains the control for PowerPacs, Migration tools and Gearbox Heat Prediction. The Add-Ins browser shows the installed PowerPacs, General add-ins.

For instruction on building General add-ins visit the ABB Robotics Developer Center web site at <http://developercenter.robotstudio.com>.

General add-ins are loaded from the following folder on your PC: C:\Program Files (x86)\Common Files\ABB Industrial IT\RoboticsIT\RobotStudio\Addins



Note

For RobotStudio 64-bit edition:

- Add-ins will be loaded from the following folder: C:\Program Files (x86)\ABB Industrial IT\RoboticsIT\RobotStudio 6.04\Bin64\Addins.

This is the path on a PC with Microsoft Windows 7, 64-bit English version on default installation. For customized installations and for operating system versions in other languages, this path may differ.

Continues on next page

13 Add-Ins tab

13.1 RobotApps

13.1 RobotApps

You can view and download RobotWare, RobotWare Addin and RobotStudio Addins from the RobotApps window. This window is divided into two panes, The names of all addins appear on one pane and the details of the selected folder are displayed on the other pane. You can download a specific version of the addin from this pane. You can also view and download contents from the ABB RobotApps web page.

Continues on next page

13.1.1 Distribution package

Overview

A distribution package may consist of one or more products. When distributed as one file, the suffix of the file is .rspak. Use the **Install Package** command in the **RobotApps** page to install a distribution package.

RobotWare Add-In for the StandAlone Controller (SAC) is a separate package. This package is available in the **RobotApps** page in the **Add-Ins** tab. You can install RobotWare Add-Ins by browsing to a RobotWare Add-In manifest (.rmf file). The **Add-Ins** browser shows the installed packages.

Locations of distribution package

In RobotStudio 6, RobotWare and related packages are referred as application data. A distribution package is available in the following locations.

- **ProgramData**: used when the appdata is shared among users on the computer. If RobotWare is installed with RobotStudio, the path is *%ProgramData%\ABB Industrial IT\Robotics IT\DistributionPackages* and on a PC with a default installation of Windows 7, the path is *C:\ProgramData\ABB Industrial IT\Robotics IT\DistributionPackages*.
- **LocalAppData**: used if a package or manifest is installed by a particular user. If RobotWare is installed with RobotStudio, the path is *Users\\AppData\Local\ABB Industrial IT\Robotics IT\DistributionPackages* and on a PC with a default installation of Windows 7, the path is *C:\Users\\AppData\Local\ABB Industrial IT\Robotics IT\DistributionPackages*.
- **Customized location (optional)**: may be used when several users share a package repository. For more information, see **Additional distribution package location** in RobotStudio Options:General:Files & Folders.



Note

In the **RobotApps** page, in the **Add-Ins** browser, when you hover the mouse pointer over a package node, the tooltip displays the location information of a specific package. Right-click an installed package and then click **Open Package Folder** to view the location of the selected package folder.

Continues on next page

13 Add-Ins tab

13.1.1 Distribution package

Continued

Unpacked data

When used by a virtual controller, the packages are unpacked into a cached location residing in a *LocalAppData* sub-folder, *Users\<user name>\AppData\Local\ABB Industrial IT\Robotics IT\RobotWare*. On a PC with a default installation of Windows 7, the path is *C:\Users\<user name>\AppData\Local\ABB Industrial IT\Robotics IT\RobotWare*. The content of this folder is similar to the RobotWare 5 Mediapool folder.



Note

To uninstall a distribution package, right-click the particular package and then click **Uninstall Package**. This removes the selected package and related, unpacked data.

13.2 Migration tools

Overview

To migrate a robot system from RobotWare 5 to RobotWare 6 you need to use the migration tools in the Add-ins tab.

If you are upgrading from RobotWare version 5.15 or earlier, you must contact ABB to replace the controller main computer by DSQC 1000 and also to get a RobotWare 6 license. You can contact your ABB Robotics Service representative at www.abb.com/contacts.

For details on the migration process, refer *Instruction - RobotWare upgrade and migration guide*.

13.3 Gearbox Heat Prediction

Overview

The Gearbox Heat Prediction Tool is an add-in for RobotStudio which helps to predict heat problems in the gearboxes. When the temperature is above a predefined value, you can adjust the cycle to reduce the temperature or order a fan that can cool down the gear.

Robots with compact gearboxes have a risk of getting overheated under certain circumstances. The gearbox temperature is supervised by *Service Information System* (SIS). SIS is a software function within the robot controller, that simplifies maintenance of the robot system. It supervises the operating time and mode of the robot, and alerts the operator when a maintenance activity is scheduled. It also supervises large robots from damaging the motors during high load operations with a safety shutdown.

The temperature supervision is based on an algorithm that predicts the stationary temperature of the gearboxes and motors of the robot. The algorithm predicts the heat based on the character of the robot motion and also the room temperature. Intensive motion (high average speed and /or high average torque and/or short wait time) will increase the heat of the gearbox and motors.

To avoid overheating, SIS stops the robot if the temperature becomes too high. For large robots, there is an option to add a cooling fan to axis 1, 2, and sometimes axis 3, to allow the robot to run even with a heavy duty program.



Note

Gearbox Heat Prediction is not supported for Tool and External axis. When a virtual controller has more than one robot, only one robot will have predictions calculated. The other robots will only display 0% chance of overheating.

Prerequisites

- 1 RobotStudio 5.14.02 or later.
- 2 RobotWare 5.14.01 or later.
- 3 RobotStudio station with controller having a programmed cycle that includes payload for the robot.

Calculating the Gearbox Heat

Use the following procedure for predicting the heat generated by the robot:

- 1 Create a new station or open a saved station. The Gearbox heat button is now visible in the **Add-Ins** tab.
- 2 In the **Add-Ins** tab, click Gearbox Heat. The **Gearbox Heat Prediction** window opens.

Continues on next page

- 3 In the **Add-Ins** tab, select **Enabled** to enable the **Gearbox Heat Prediction** tool .

**Note**

For a manipulator without compact gear, **Gearbox Heat Prediction** is disabled.

- 4 Run a simulation.

**Note**

For RobotStudio Basic, the **Play** button in the **Simulation** tab will be disabled. As such, you will be unable to run the simulation from the **Simulation** tab. In such a scenario, use the **Play** button which will now be visible in the **Gearbox Heat Prediction** tab window to run the simulation.

**Note**

The data is recorded during the simulation only if the **Gearbox Heat** tool is enabled. After the recording is finished, you can perform another recording or perform a calculation for heat related problems.

- 5 In **Cycles**, define the behavior of the cycle for predicting the heat generated by the robot:
 - **Continuous**: Select this option if you want the robot to continuously calculate the predictions without waiting time between two consecutive cycles.
 - **Number of cycles per hour**: Select this option if you want to manually specify the number of cycles per hour for calculation.
 - **Waiting time between cycles (sec)**: Select this option to specify the waiting between cycles. Specify the waiting time in seconds.
- 6 In **Ambient Temperature**, define the ambient temperature.
 - Use the slider to change the temperature.
 - Select **Use temperature from controller(s)** to reset the the ambient temperature.

**Note**

The ambient temperature used in the calculations should be the same that is used in the configuration of the actual robot in its real environment.

- 7 Calculate the result in either of the following ways:
 - In the **Recordings** section, either double-click a recording or select a recording and click **Calculate**.

Continues on next page

- In the **System** section, either double-click a controller or select a controller and click **Calculate**.

 **Note**

- The **Recordings** section displays the recordings to be analyzed when **Gearbox Heat Prediction** is enabled.
- The **System** section displays all the available controllers. Data for all controllers are recorded at all times and you can select the controller to be analysed from the list.

The results are displayed for each joint and with fans for the joints that can have fans installed as an option.

 **Note**

The following factors influence the heat accumulated:

- Axis speed
- Payload
- Room temperature (ambient temperature)
- Waiting time (to allow robot to cool down)

 **Note**

The calculated energy is displayed as different heat levels:

- **Green:** Indicates no heat problem
- **Orange:** Indicates it is recommended to install a fan.
- **Red:** Indicates a fan must be installed.
- **Grey:** Indicates it is not possible to calculate the possible energy level for this joint.
- **Not available:** Indicates the joints that cannot have a fan installed.

 **Note**

Recommended action is displayed along with the warning level for each joint.

- **Joint:** Represents the joint.
- **Without fan:** Displays the percentage of heat levels calculated to the corresponding joint without fan.
- **With fan:** Displays the percentage of heat levels calculated to the corresponding joint with fan.
- **Action:** Displays the recommended action.

14 Context menus

14.1 Add to Path

Creating a move instruction based on an existing target

- 1 Select the target for which to create the move instruction.
- 2 From the **Home** menu, in the **Path Programming** group, select the type of move instruction to create.
- 3 Click **Add to Path**.

The move instruction will appear under the path node as a reference to the original target.

14 Context menus

14.2 Align Frame Orientation

14.2 Align Frame Orientation

The Align Frame Orientation dialog box

Reference	Specify the frame or target for which you want to align the selected objects here.
Align Axis	The axis you specify here will be aligned as on the reference target/frame for all selected objects.
Lock Axis	The axis you specify here will not be changed on the selected objects by the align function, but will keep its orientation.

14.3 Align Target Orientation

Aligning target orientation

- 1 Select the targets whose orientation you wish to change.
- 2 Click **Align Target Orientation** to bring up a dialog box.
- 3 In the **Reference** box, specify the target whose orientation you want to use as reference, by first click in the box and then selecting the target either from the graphics view or the **Layout** browser.
- 4 In the **Align Axis** box, select the axis whose orientation you want to copy from the reference target to the selected ones.
- 5 In the **Lock Axis** box, select the axis to rotate the target around. The orientation of this axis will not be changed on the targets. For example, if the Z axis of all targets are orientated normally to the surface of the work piece and you want to keep it this way, you should lock the Z axis.
- 6 Click **Apply**.

**Tip**

You can change the Align and Lock axis and click Apply again to reorientate the targets until you deselect them.

14 Context menus

14.4 Attach to

14.4 Attach to

Attaching an object

- 1 In the **Layout** browser, right-click the child object, click **Attach to** and click the parent object in the list.

Attaching an object by drag and drop

- 1 In the **Layout** browser, drag the child object to the parent object.
- 2 In the displayed message, click the corresponding button:

To	Click
attach the child object and move it to the attachment point	Yes
attach the child object and keep its position	No
not perform the attachment	Cancel

14.5 Configurations

Auto Configuration

The Auto Configuration function runs through the path and optimizes the configurations for linear and circular move instruction with respect to their preceding targets. Joint move instructions are not affected. Use the Configurations tool on the individual joint targets to change the configuration of joint move instructions. In the **Paths&Targets** browser, right-click a path, select **Configurations** and then select **Auto Configuration**.

The robot now steps through each target in the path and sets the configurations.

Verify Configurations

The Verify configuration function runs through the path and check if the targets are reachable with the specified configurations. Use the following procedure for verifying the existing configuration:

In the **Paths&Targets** browser, right-click a path, select **Configurations** and then select *Verify Configurations*.

Auto Configuration for a dual-arm robot

A normal robot arm has six axis or degrees of freedom of movement whereas a dual-arm robot has seven degrees of movement. Hence by configuring its arm angles, a dual-arm robot can adapt several ways to reach a target. You can set the arm angle while applying auto configuration.

14.6 Configurations

Manually setting a robot axis configuration for single targets

- 1 In the **Paths&Targets** browser, select a target and then click **Configurations** to bring up a dialog box.
- 2 If more than one configuration solution exist, examine them by clicking them, one at a time.

The position of the robot with the selected configuration will be displayed in the graphics window, and the joint values for the configuration will be displayed in the joint values list below the configurations list.

In most cases, selecting a configuration similar to the previous one is the best choice.

- 3 Select the configuration to use and click **Apply**.

14.7 Convert Frame to Workobject

Converting a frame to a workobject

- 1 In the **Layout** browser, select a frame.
- 2 Click **Convert Frame to Workobject**. The new workobject will appear in the **Paths&Targets** browser.
- 3 Optionally, rename or edit the workobject in any way.

14 Context menus

14.8 Work envelope

14.8 Work envelope

Overview

The defined area of space through which a robot can move. A robot can only perform within the confines of this work envelope.

Viewing the work envelope of a robot

- 1 In the **Layout** browser, right-click any robot.
- 2 From the context menu, select **Show Work Envelope**, the work envelope options are displayed on the left hand pane.
- 3 Select the object and the required view, for example, **Robot Wrist/Active Tool** and **3D Volume/2D Outline**. The corresponding work envelope gets displayed.

14.9 Convert to Move Circular

Prerequisites

At least two targets, the via-point target and the end point target, must have been created.

A path containing at least the via-point target and the end point target, in correct order, must have been created.

Converting to Move Circular

- 1 In the **Paths&Targets** browser, expand the path node that contains the move instruction to be converted.
- 2 Select the move instruction that contains the via-point of the circular motion together with the succeeding move instruction, which will serve as the end point. You can select several instructions by holding down the **SHIFT** key while clicking the instructions.
- 3 Click **Convert to Move Circular**. The two selected move instructions will be converted to a circular move instruction, which includes the via-point and the end point.

**Tip**

To convert two move instructions to a circular motion, you can also select and right-click both move instructions at once and then click **Convert to Circular**.

14 Context menus

14.10 Copy / Apply Orientation

14.10 Copy / Apply Orientation

Copying and applying an orientation

- 1 In the browser, select the object or target from which to copy the orientation.
- 2 On the **Modify** menu, click **Copy Orientation**.
- 3 In the browser, select the object or target to which to apply the orientation.
- 4 On the **Modify** menu, click **Apply Orientation**. This can be performed on several targets or a group of selected targets.

14.11 Detach

Detaching an object

- 1 In the **Layout** browser, right-click the attached object (child) and then click **Detach**. The child will be detached from the parent and return to its position before the attachment.

14.12 Defeature

Overview

Defeature identifies and removes certain features from a 3D model. It simplifies the model by removing unnecessary details and provides a flexible interface with feature recognition parameters defining the desired level of detail. The defeature function works on fillets, chamfers, and round holes.

Use the Defeature function to recognize and remove the following features:

- **Holes:** Cylindrical, conical, spherical, and toroidal holes are supported. Holes below the specified radius will be recognized.
- **Chamfers:** Chamfers are straight-line transitions between surfaces. If the un-chamfered intersection of the adjoining faces would otherwise form a right angle, then the chamfer will typically be uniform and pitched at 45°. Chamfers below the specified width will be recognized.
- **Blends:** Blends are smooth transitions with continuity matching between surfaces. Constant radius and variable radius blends are supported. Blends below the specified radius will be recognized.



Note

All the previewed features cannot be removed by RobotStudio.

Prerequisite

- Part must contain CAD geometry (SAT, STEP or similar) and not only the graphical data (STL, VRML, or similar).
- Part must be imported into the station.

Defeaturing a 3D model

- 1 In the **Layout browser**, right-click the model.
- 2 Click **Modify** and then from the context menu, click **Defeature**.
The Defeature dialog box appears.
- 3 Specify the parameters to define the desired level of detail. The recognized features can be viewed through the **Preview** function.
- 4 Click **Apply**.
Small features and unnecessary details are removed based on the defined parameters.

14.13 Execute Move Instruction

Prerequisites

The move instruction must exist.

A virtual controller must be running for the robot with the move instruction.

Executing a move instruction

- 1 In the **Paths&Targets** browser, browse to the motion instruction to execute through the **Controller, Tasks and Paths** nodes.
- 2 Click **Execute move instruction**. The TCP of the active robot will move from the current location to the motion instruction according to the programmed motion properties. If the target for the motion instruction does not have a stored configuration, the robot will use the configuration nearest the current one.

14 Context menus

14.14 External Axis Interpolation

14.14 External Axis Interpolation

Prerequisites

You need to have a path selected and a robot with external axis configured.

Interpolating external axis

- 1 In the **Paths&Targets** browser, select a path, right-click and select **Interpolate External Axis**.

The Interpolate External Axis dialog box appears.

- 2 Select the mechanical unit from the **Mechanical Unit** drop-down list.
- 3 Select the axis to interpolate from the **Axis** drop-down list.
- 4 In the **Interpolation** drop-down list,

select...	to...
Constant Value	set a constant value for the axis in each robot target. You can set the value from the Value drop-down list.
TCP Offset	calculate an axis value such that the <ul style="list-style-type: none">• For a linear axis, robot base is translated the offset distance relative to the target along the axis direction.• For a rotating axis, external axis value is calculated so that the angle between the TCP approach direction and the rotational axis zero position is kept constant at the offset angle.
Constant Speed	Calculates the speed for the entire path or between the selected instructions for smooth functioning of the external axis.

- 5 Click **Apply**.

14.15 Graphic Appearance

Overview

With the graphic appearance dialog box you set the graphic properties for an individual object. These settings override the generic settings made in the options dialog box. To launch the Graphic Appearance dialog box right-click a part in the browser and select Graphic Appearance from the context menu.

The right part contains a preview of the part and controls for setting the behavior and appearance of the preview. The user can work on the entire part, or on individual bodies or faces by selecting them in the preview.

Graphic Appearance: The Material tab

The Material tab contains controls for setting material parameters or selecting a material from the list of user defined and predefined materials. It is also possible to save the current material to the user defined materials.

The Material tab contains two groups: Colors and Textures. The Color group contains parameters for controlling the color properties of an object. The Textures group contains the settings for textures. The color and texture setting together define a material. You can save your current settings as a new material for later re-use or apply an existing material.

The following options are available:

- **Apply material** : Provides a list of predefined material that can be applied to the object.
- **Save material** : Saves the specified combination of color and texture settings as a material.

Color group

Simple Color	Click this color box to select another color for the object.
Opacity	Controls the transparency of the object.
The color boxes	Set the color of the object for different light situations here.
Shininess	Specify the reflectiveness of the object here.

Textures group

Base texture	<p>Specifies the basic structure of the selected part. It is a standard 24-bit image displayed on a 3D surface.</p> <p> Note Transparency of textures is provided only for .png images.</p>
Specify texture size	<p>Check this option to specify the texture size. When a material with a specified texture size is applied to a geometry, RobotStudio tries to adjust the texture coordinates so that the texture image covers the specified area.</p> <p> Note This option works best on flat surfaces; on curved surfaces the size will be approximate.</p>

Continues on next page

14 Context menus

14.15 Graphic Appearance

Continued

Blend Mode	Specifies how the texture is combined with the specified object color.
Environment map	Provides a highly reflective appearance to the surface.
Normal Map	Specifies a texture that defines the bumpiness of the surface

Graphic Appearance: The Properties tab

The Properties tab contains controls for surface properties and texture coordinates.

Surface Properties

Render both sides	By selecting this option surfaces will be rendered regardless of orientation.
Invert surface(s)	Selected surfaces can be inverted by this button. This process is simplified by checking Highlight inverted faces , which will cause the background of surfaces to be displayed in red.
Generate new normals	Generate new normals. If the surface normals of an imported geometry are of poor quality, they can be recreated by clicking this button.

Texture coordinates

Swap u/v	Click this button to swap the horizontal and vertical directions of the texture.
Modify	Select along which directions the commands listed below shall be applied. u is the horizontal axis of the texture. v is the vertical axis of the texture.
Normalize	Click this button to set the ratio between the dimensions of the object and the texture to 1.
Flip	Click this button to invert the coordinates along the selected axes. This is the same as mirroring around the other axis.
Stretch	Click this button to stretch the texture along the selected axes.
Shrink	Click this button to shrink the texture along the selected axes.
Shift<	Click this button to move the texture along the selected axes.
Shift>	Click this button to move the texture along the selected axes.

14.16 Remove internal geometry

Overview

This function reduces the model by removing bodies and faces that are not visible from outside. Internal bodies will be removed completely while internal faces will be removed from the graphical representation. To restore the faces, the graphical representation must be created.

Removing the internal geometry

- 1 In the **Layout** browser, right-click the model.
- 2 Click **Modify** and then from the context menu, click **Remove internal geometry**.

Bodies and faces that are not visible from outside will be removed.

14 Context menus

14.17 Go to Visualization and Go to Declaration

14.17 Go to Visualization and Go to Declaration

Go to Visualization

The **Go to visualization** context menu command is available for targets in the RAPID editor. It takes you to the 3D graphical window to show you where the target is found.



Note

This command requires that the RAPID code has been synchronized to the station.

Go to Declaration

In the Paths & Targets browser, the **Go To Declaration** context menu command is available for targets. This command takes you back to the target in the RAPID editor.



Note

This command requires that the RAPID code has been synchronized to the virtual controller.

14.18 Zone visualization

The function shows a semitransparent sphere at each target, that represents the TCP zone of the programmed zone data. To access this function right-click **Path** and then select **View** and then click **Show Programmed Zones** or click **Show Actual Zones**.

Commands

Show programmed zones	Shows a 3D sphere of the same radius as the zone size defined in the RAPID program.
Show actual zones	Shows a 3D sphere of the same radius as the minimum of the zone size the user sets or a zone with radius half the distance to the preceding or succeeding target in the path. This corresponds to the zone reduction carried out by the controller during program execution.

Depending on the zone data the sphere takes different colors white, red and purple, white is the default color.

- Red: If the zone data contains the preceding or subsequent target, that is, if the zone data is larger than the closest distance.
- Purple: If the zone data is greater than half the distance to the preceding or subsequent target.
- White: The default color



Note

True move will not work for a user defined customized zone.

14.19 Zone reduction

The zone size cannot be larger than half the distance to the preceding or succeeding target in the path. If a larger zone is specified, the robot automatically reduces it.

The zonedata of zones that are red or purple when visualized with **Show actual zones** are replaced by the largest possible standard zone data, for example, if the largest possible zone is 123 mm, then the zonedata is replaced by z100.

To reduce zone size, follow these steps:

- 1 In the **Paths&Targets** browser or the graphics window, select the path.
- 2 Right-click and select **Path** and then select **Reduce zones** to access this option.

14.20 Interpolate Path

Reorienting targets in a path by interpolation

- 1 In the **Layout** browser or the graphics window, select the path with the targets to reorient.
- 2 Click **Interpolate Path.** to bring up a dialog box.
- 3 With the **Interpolate type** options, select whether to use **Linear** or **Absolute** interpolation.

Linear interpolation distributes the difference in orientation evenly, based on the targets positions along the length of the path. By contrast, absolute interpolation distributes the difference in orientation evenly, based on the targets' sequence in the path.

- 4 If using the **Select Start/End** option, select the start and end targets for the interpolation in the **Start target** and **End target** boxes, respectively.
- 5 Optionally, with the **Lock Axis** options, select an axis to lock.
- 6 Click **Apply.**

14 Context menus

14.21 Invert

14.21 Invert

Inverting the direction of a face

- 1 In the **Layout** browser, click the arrow on the upper right corner and then select **Show Bodies** and **Show Faces/Curves**.
- 2 Expand **Part** and **Body** nodes to see the faces.
- 3 Right-click a face and then click **Invert**.

If the option **backface culling** is activated, then the face will shift from visible to invisible, or vice versa, depending on the direction you view the face from. If **backface culling** is deactivated, then there will be no visible indication that the direction of the face has been inverted.

14.22 Jump to Target

Jumping to a target

- 1 In the **Paths&Targets** browser, browse to the target to jump to through the **Controller**, **Tasks** and **WorkObjects** nodes.
- 2 Click **Jump to target**.
If the target has a valid configuration for the robot axes stored, the active TCP of the robot will immediately be positioned at the target. If no valid configuration is stored, the **Select Robot configuration** dialog box is displayed.
- 3 In the **Select Robot Configuration** dialog box, select a suitable configuration solution and click **Apply**. The selected configuration is now stored with the target.



Note

You can deactivate the configuration check when jumping to targets. The robot will then use the configuration solution closest to the current one when reaching the target. For more information, see [Options on page 217](#).

14 Context menus

14.23 Linked Geometry

14.23 Linked Geometry

Overview

The Linked Geometry feature allows you to load geometry from a shared repository. If the source file is updated, then the station will be updated with a single click.

Adding Link

You can add a link to a geometry in two ways:

- 1 In the **Home** tab, click **Import Geometry** to open a dialog box.
Select the option **Link to Geometry**.
- 2 In the **Layout** browser, right-click an existing part in the station and select **Add Link**.

A dialog box opens where you can select the CAD file to be linked.

Editing Link

To edit an existing link:

- 1 In the **Layout** browser, right-click an existing part in the station.
 - 2 Select the option **Link to Geometry** and click **Edit Link**.
-

Deleting Link

To delete an existing link:

- 1 In the **Layout** browser, right-click an existing part in the station.
 - 2 Select the option **Link to Geometry** and click **Delete Link**.
-

Updating Linked Geometry

To update a linked geometry:

- 1 In the **Layout** browser, right-click an existing part in the station, component group or the station.
- 2 Select the option **Link to Geometry** and click **Update Linked Geometry**.

The update result is displayed in the output window.



Note

When you select a component group or a station, all linked geometries within the group or station is updated. If the timestamp on the file is newer than the timestamp stored in the station, all corresponding parts will be updated from the source location.

14.24 Modify Library Component

Modifying a library component

- 1 In the **Layout** browser, select the library you wish to modify.
- 2 Click **Disconnect Library**.
- 3 Select the library and then make any modifications to it.
- 4 Select the modified library, and then click **Save As Library**.

14 Context menus

14.25 Mechanism Joint Jog

14.25 Mechanism Joint Jog

Jogging the joints of a robot

- 1 In the **Layout** browser, select the robot.
- 2 Click **Mechanism Joint Jog** to bring up a dialog box.
- 3 Each row in the **Jog Joints** dialog box represents a joint of the robot. Jog the joints either by clicking and dragging the bar at each row, or by using the arrows to the right of each row.
Set the length of each step in the **Step** box.

The Mechanism Joint Jog dialog box

Joint	Move the joints of the objects by dragging the slider on the row corresponding to each joint. Alternatively, click the buttons to the right of the row, or type a value.
Cfg	The current configuration value.
TCP	The current position of the TCP.
Step	Specify the length of the joint movements for each click of the buttons to the right of each joint row.
External Axis	If the robot uses external axes, you can select an axis to jog from this list. The external axes must belong to the same task as the object you are jogging for occurring in this list. If no external axes are present in the same task, this list is not available.
Lock TCP	Select this check box to reposition the robot according to the jogging of the external axis. For track-external axes the robot will reposition so that the TCP is locked relative to the world coordinate system. For positioner-external axes the robot will reposition so that the position of the robot's TCP is locked relative to the attachment point of the positioner. The robot will move with the positioner the same way as when using multi-robot jog. If no external axes are present in the same task, this check box is not available.
External axes joint	Move the joint of the external axes by dragging the slider on the row corresponding to each joint. Alternatively, click the buttons to the right of the row, or type a value. If no external axes are present in the same task, this check box is not available.

Jogging a conveyor



Note

Using the following step, you can attach a workobject to the conveyor:
Click **Workpiece source**, right-click the part and then select **Attach Workobject** and then click **workobject**.

- 1 In the **Layout** browser, click the **Conveyor** node.
- 2 Right-click **Conveyor** and then select **Conveyor Jog**.
The **Conveyor Jog** tab opens.

Continues on next page

- 3 In the **Conveyor Jog** tab, click **Connection and attached Workobject**.
- 4 Move the slider to jog the conveyor.

14.26 Mechanism Linear Jog

Jogging the TCP of a robot by using the Linear Jog dialog box

- 1 In the **Layout** browser, select the robot.
- 2 Click **Mechanism Linear Jog** to bring up a dialog box.
- 3 Each row in the **Linear Jog** dialog box represents a direction or rotation for the TCP. Jog the TCP along the preferred direction or rotation, either by clicking and dragging the bar at each row, or by using the arrows to the right of each row.
- 4 From the **Reference** list, you can select the coordinate system that you want to jog the robot relative to.
- 5 In the **Step** box, specify the step movement per deg/rad.

14.27 Mirror Path

The Mirror Path dialog box

Duplicate	Select this option to keep the existing path when mirroring.
Replace	Select this option to remove the existing path after mirroring.
X-Y, X-Z and Y-Z	Select the plane to mirror the path around with these options. The plane is defined by the selected axes and position of the reference coordinate system selected below.
Reference	Select the frame or coordinate system to define the mirror plane in. To use another frame than any of the predefined ones, select Select Frame from the list and specify the frame in the box below.
Select Frame	If Select Frame is used as Reference frame, specify the frame to use here by first clicking in the box and then selecting the frame from the graphics window or the Layout browser.
Flip axis X/YZ	Select one of these options to mirror the orientation of the targets. When any of these are selected, the robot will approach the targets in a mirrored way. The axis you select will change the most for achieving the mirrored orientation, while the other one will be kept as near to its current direction as possible. The axis that is set to the robot's approach vector cannot be selected.
Keep orientation	Select this option to keep the orientation of the targets. When selected, the robot will go to the mirrored position, but approach the target from the same direction as for the original target.
Mirror Robot Configuration	Select this option to also mirror the robot axis configuration for the targets. Selecting this option will mirror the robot's motions completely. For using this option, the following conditions must be met: <ul style="list-style-type: none"> • The Reference frame must be set to <i>Baseframe</i>. • The Mirror plane must be set to X-Z. • The tool of each move instruction must have its TCP in the X-Z plane of <i>tool0</i>. • All targets in the path must have robot axis configuration set. • The virtual controller must be running.
More / Less	Click this button to show or hide the commands for naming and location of generated targets and paths.
New path name	Specify the name of the path that will be generated by the mirroring here.
Target prefix	Specify a prefix for the targets that will be generated by the mirroring here.
Receiving robot	Specify the robot task in which the new targets and path shall be created.
Receiving work object	Specify the work object in which the new targets shall be created.

14 Context menus

14.28 Mirror

14.28 Mirror

Mirroring a part

- 1 In the **Layout** browser, select the part to mirror and right-click.
- 2 Select **Mirror** and then click one of the following options from the context menu:

select...	to create a new part..
Mirror YZ	around YZ plane
Mirror ZX	around ZX plane
Mirror XY	around XY plane



Note

The mirror feature is applicable only to objects of type body and part that contains geometry. Parts and bodies that are imported without geometry cannot be mirrored. See [Libraries, geometries and CAD files on page 41](#).

For information on mirroring a path, see [Mirror Path on page 513](#).

14.29 Modify Curve

Overview

The following table provides an overview of the generic content available in the Modify Curve dialog box.

Extend	Extend a curve at any vertex with a straight line in the direction of the curve's tangent.
Join	Join two or more curves into one. The original curves will be deleted when joining curves.
Project	Project a curve onto a surface or a body, creating a new curve on the target part.
Reverse	Reverse the direction of curves.
Split	Split a curve in two bodies. Only open curves can be split.
Trim	Cut a segment of a curve between intersection or end points.

Extending a curve with a straight line in the direction of the curve's tangent

- 1 Click the **Modify curve** and then select **Extend Curve** from the drop down menu.
The **Extend Curve** menu opens.
- 2 Click the curve you want to extend.
- 3 In the **From start vertex** and **From end vertex** boxes, type or select the required length you want to extend the curve. In the graphics window a yellow line displays a preview of the extension.
- 4 Click **Apply**.

Joining curves

- 1 Click the **Modify curve** and then select **Join Curves** from the drop down menu.
The **Join Curves** menu opens.
- 2 Click the curves to join in the graphics window. The curves may be either intersecting or adjacent to be joined.
The **Selected curves** list displays the curves that will be joined. To remove a curve from the list, select the list entry and press the DEL key.
- 3 In the **Tolerance** box, enter a value. Adjacent curves whose end points lie within the tolerance will be valid for the operation.
- 4 Click **Apply**.

Projecting curves on a surface

- 1 Click the **Modify curve** and then select **Project Curve** from the drop down menu.
The **Project Curves** menu opens.
- 2 Click the curves to project in the graphics window.
Note that when you rest the pointer over the curve, the projection direction is displayed. The project direction is always the negative Z direction of the

Continues on next page

14 Context menus

14.29 Modify Curve

Continued

User Coordinate System. To change the projection direction, create a new frame with the desired orientation and set it as user coordinate system.

The **Selected curves** list displays the curves that will be projected. To remove a curve from the list, select the list entry and press the DEL key.

- 3 Click in the **Target bodies** list and then click the bodies to project on in the graphics window. The bodies must be in the projection direction and be big enough to cover the projected curves.

To remove a bodies from the list, select the list entry and press the DEL key.

- 4 Click **Apply**. A new curve will now be created in a new part, wrapped around the surface of the selected bodies.

Reversing curves

- 1 Click the **Modify Curve** and then select **Reverse Curve** from the drop down menu.

The **Project Curves** menu opens.

- 2 Click the curves to reverse in the graphics window.

Note that when you rest the pointer over a curve, the current direction of the curve is displayed by yellow arrows.

The **Selected curves** list displays the curves that will be reversed. To remove a curve from the list, select the list entry and press the DEL key.

- 3 Click **Apply**. The curves will now be reversed.

Splitting a curve

- 1 Click the **Modify Curve** and then select **Split Curve** from the menu to open the tool.

- 2 Click the curve at the point to split at. Only open curves can be split.

Note that when you rest the pointer over the curve, point of the split is highlighted. This point is affected by the current snap mode setting.

- 3 Click **Apply**. The curve will now be split to two separate curves in the same part.

Trimming a curve

- 1 Click the **Modify Curve** and then select **Trim Curve** in the menu to open the tool.

- 2 Click the curve segment to trim.

Trim only works on single curves with intersection points. If you want to trim a curve that intersects with another curve, first join the two curves.

- 3 Click **Apply**. The selected part of the curve will now be removed.

14.30 Modify External Axis

Modifying external axis positions in targets

- 1 Select the targets (one or several) you want to modify, either in the **Layout** browser or in the graphics window. If you select several targets, the values you specify will be applied to all selected targets.
- 2 Click **Modify External Axis** to bring up a dialog box.
- 3 Edit the values of the axis by performing any of the following:

Action	Description
Type a new position value for an axis	In the Eax column, select the value of the external axis you want to edit, and enter the new value.
Jog the axis to the new position	Use the arrow buttons to the left of the Joint Values column for jogging the axis. Then click the right arrow button between the Joint values column and the Eax column to transfer the current joint value to the Eax value.

- 4 Click **Apply**.

The Modify External Axis dialog box

<	Jog the joint of the external axis corresponding to each row by clicking the < button.
>	Jog the joint of the external axis corresponding to each row by clicking the > button.
value box	Enter the axis value for the corresponding joint of the external axis in the value box.
<-	With the arrow left button, you transfer the value from the Eax box to the corresponding value box.
->	With the arrow right button, you transfer the value from the value box to the corresponding Eax box.
Eax	Specify the value of the corresponding joint of the external axis.

14 Context menus

14.31 Modify Instruction

14.31 Modify Instruction

Modifying an instruction

- 1 In the **Paths&Targets** browser, select the instruction you want to modify. If you want to apply the same properties to several instructions, press the **CTRL** key and select them.
- 2 Click **Modify Instruction** to bring up a dialog box.
- 3 For move instructions, select joint or linear motion in the **Motion type** list.
- 4 In the **Instruction Argument** group, modify the values for the instruction.
For details about each argument, see the selected instruction in the *RAPID Reference Manual*. For an overview of the arguments for move instructions, see below.
- 5 When you have finished modifying, click **Apply**.

It is possible to change common move instruction parameters such as speed, zone and tool without opening the edit instruction tool using the context menu. Right-click any move instruction, then select **Modify Instruction** to access **Speed, Zone** or **Tool**.

Arguments for move instructions

The table below is an overview of common arguments for move instructions. For detailed information about the arguments, see the selected instruction in the *RAPID Reference Manual*.

To set the	Use
subsequent instructions to be executed at once.	\Conc
destination target for the instruction target.	ToPoint
speed for the tool center point, the tool reorientation and external axes.	Speed
velocity of the TCP in mm/s directly in the instruction (it will be substituted for the corresponding speed data).	\V
total time in seconds during which the robot moves (it will be substituted for the corresponding speed data).	\T
size of the generated corner path.	Zone
position accuracy of the robot TCP directly in the instruction (the length of the path will be substituted for the corresponding zone specified in the zone data).	\Z
tool used for the movement (the TCP of this tool will be positioned at the destination target).	\Tool
workobject to which the robot position in the instruction belongs.	\Wobj

14.32 Modify Mechanism

The Modify Mechanism dialog box

See [The Modify Mechanism dialog box on page 344](#).

14.33 Modify Tooldata

Modifying tooldata

- 1 In the **Layout** browser, select the tooldata you want to modify.
- 2 Click **Modify Tooldata** to bring up a dialog box.
- 3 In the **Misc Data** group:
 - Modify the **Name** of the tool.
 - Select if the tool is to be held by the robot in the **Robot holds tool** list.
- 4 In the **Tool Frame** group:
 - Modify the **Position x, y, z** of the tool.
 - Modify the **Rotation rx, ry, rz** of the tool.
- 5 In the **Load Data** group:
 - Enter a new **Weight** for the tool.
 - Modify the **Center of gravity** for the tool.
 - Modify the **Inertia** for the tool.
- 6 In the **Sync Properties** group:
 - In the **Storage type** list, select **PERS** or **TASK PERS**. Select **TASK PERS** if you intend to use the tooldata in MultiMove mode.
 - In the **Module** list, modify the module in which to declare the tooldata.
- 7 Click **Apply**.

14.34 Modify Workobject

Modifying a workobject

- 1 In the **Layout** browser, select the workobject you want to modify.
- 2 Click **Modify Workobject**. to bring up a dialog box.
- 3 In the **Misc Data** group, modify the values for the workobject:
 - Enter a **Name** for the workobject.
 - In the **Robot holds workobject** list, select **True** or **False**. If you select **True**, the robot will move the work piece instead of the tool.
 - In the **Moved by mechanical unit** list, select the mechanical unit with which the robot movements are coordinated. This setting is only valid when **Programmed** has been set to **False**.
 - In the **Programmed** list, select **True** or **False**. **True** means that the workobject will use a fixed coordinate system, and **False** that a movable coordinate system (that is, coordinated external axes) will be used.
- 4 In the **User Frame** group, do one of the following:
 - Modify the user frame by entering values for the **Position x, y, z** and the **Rotation rx, ry, rz** for the workobject. Click in one of these boxes, and then click the position in the graphics window to transfer the values.
 - Modify the user frame by using the **Frame by points** dialog box, see [Frame from Three Points on page 237](#) .
- 5 In the **Object Frame** group, do one of the following:
 - Modify the object frame by selecting values for **Position x, y, z** and **Rotation rx, ry, rz** for the workobject.
 - Modify the object frame by using the **Frame by points** dialog box.
- 6 In the **Sync Properties** group, modify the values for the workobject:
 - In the **Storage type** list, select **PERS** or **TASK PERS**. Select **TASK PERS** if you intend to use the workobject in MultiMove mode.
 - In the **Module** list, select the module in which to declare the workobject.
- 7 Click **Apply**.



Note

If you change the position of a workobject that is used in a program, you have to synchronize the affected paths to the virtual controller; otherwise, the program will not be updated.

14 Context menus

14.35 Move Along Path

14.35 Move Along Path

Prerequisites

At least one path must have been created in the station.

A virtual controller must be running for the robot to move along the path.

Moving along a path

- 1 In the **Paths&Targets** browser, select the path to move along.
- 2 Click **Move along path**. In the graphics window, the robot will move along the path.

14.36 Move to Pose

Prerequisites

At least one joint position must be defined.

Only one mechanism may be selected at a time.

Moving to a pose

- 1 In the **Layout** browser, select one mechanism to move.
- 2 Click **Move to Pose** and then click one of the available poses. In the graphics window, the mechanism will move to the pose.

14 Context menus

14.37 Offset Position

14.37 Offset Position

Offset the position an item

- 1 Right-click the item you want to move.
- 2 Click **Offset Position** to bring up the **Offset Position** dialog box.
- 3 In the dialog box, select the reference coordinate system you want to use:

If you want to move the item	Select
relative to its own coordinate system	Local
relative to the coordinate system of its parent	Parent
relative to the coordinate system of the station	World
relative to a user-defined coordinate system	UCS
relative to a target reference frame	Target Reference Frame This option is available only for targets.

- 4 In the **Translation X, Y, Z** boxes, either type the offset, or select it by first clicking in one of the value boxes and then clicking the point in the graphics window.
- 5 Specify the **Rotation** for the item.
- 6 Click **Apply**.

14.38 Place

Placing an item

- 1 Select the item you want move.
- 2 Click **Place** and then click one of the commands to bring up a dialog box.

If you want to move the item	Choose
from one position to another without affecting the orientation of the object. Select the axes to be affected.	One Point
according to the relationship between a start and a finish line. The object will move to match the first point, then it will rotate to match the second point.	Two Points
according to the relationship between a start plane and a finish plane. The object will move to match the first point, then it will rotate to match the third point.	Three Points
from one position to a target or frame position and simultaneously change the orientation of the object according to the frame orientation. The position of the object changes according the orientation of the to-point coordinate system.	Frame
from one frame of reference to another	Two Frames

- 3 Set the reference coordinate system you want to use.
- 4 Click the points in the graphics window to transfer values to the from-point boxes to the to-point boxes. For detailed information, see the tables below.
- 5 Click **Apply**.

The Place Object by One Point dialog box

Reference	Select the reference coordinate system to which all positions or points will be related.
Primary Point - From	Click in one of these boxes, and then click the primary point in the graphics window to transfer the values to the Primary Point - From boxes.
Primary Point - To	Click in one of these boxes, and then click the primary point in the graphics window to transfer the values to the Primary Point - To boxes.
Translate along these axes	Select whether the translation is to be performed along the X, Y or Z axis, or several of the axes.

The Place Object by Two Points dialog box

Reference	Select the reference coordinate system to which all positions or points will be related.
------------------	--

Continues on next page

14 Context menus

14.38 Place

Continued

Primary Point - From	Click in one of these boxes, and then click the primary point in the graphics window to transfer the values to the Primary Point - From boxes.
Primary Point - To	Click in one of these boxes, and then click the primary point in the graphics window to transfer the values to the Primary Point - To boxes.
Point on X-Axis - From	Click in one of these boxes, and then click the point on the x axis in the graphics window to transfer the values to the Point on X-Axis - From boxes.
Point on X-Axis - To	Click in one of these boxes, and then click the point on the x axis in the graphics window to transfer the values to the Point on X-Axis - To boxes.
Translate along these axes	Select whether the translation is to be performed along the X, Y or Z axis, or several of the axes.

The Place an Object by Three Points dialog box

Reference	Select the reference coordinate system to which all positions or points will be related.
Primary Point - From	Click in one of these boxes, and then click the primary point in the graphics window to transfer the values to the Primary Point - From boxes.
Primary Point - To	Click in one of these boxes, and then click the primary point in the graphics window to transfer the values to the Primary Point - To boxes.
Point on X-Axis - From	Click in one of these boxes, and then click the point on the x axis in the graphics window to transfer the values to the Point on X-Axis - From boxes.
Point on X-Axis - To	Click in one of these boxes, and then click the point on the x axis in the graphics window to transfer the values to the Point on X-Axis - To boxes.
Point on Y-Axis - From	Click in one of these boxes, and then click the point on the y axis in the graphics window to transfer the values to the Point on Y-Axis - From boxes.
Point on Y-Axis - To	Click in one of these boxes, and then click the point on the y axis in the graphics window to transfer the values to the Point on Y-Axis - To boxes.
Translate along these axes	Select whether the translation is to be performed along the X, Y or Z axis, or several of the axes.

The Place Object with Frame dialog box

Select Frame	Specify the name of the frame with which you want to place the object.
---------------------	--

The Place by Two Frames dialog box

From	Select the frame object (For example, Target, Workobject, Tooldata or Frame) from this dropdown list to set the From point of moving the object.
To	Select any of the frame object (For example, Target, Workobject, Tooldata or Frame) from this dropdown list to set the To point of moving the object.

14.39 Protected Smart Component

You can protect a Smart Component from being edited. To protect the smart component, right-click the smart component, and then click **Protected**. You can also optionally specify a password that will be required to unlock the component for edits.

For more information on protected smart components, see *Protecting a Smart Component from edits* in the section [Smart Component on page 284](#).



Note

Protecting a Smart Component in this manner is a way of hiding complexity, and is not for providing security or securely protecting it.

14 Context menus

14.40 Remove Unused Targets

14.40 Remove Unused Targets

Removing unused targets

- 1 In the **Paths&Targets** browser, select either the *Controller* node or the *Task* node from which you wish to remove the unused targets, and then click **Remove Unused Targets**.
- 2 To the question **Are you sure you want to remove unused targets?**, answer **Yes**. All targets that not are used by any move instructions are now removed.

14.41 Rename Targets

Renaming targets

- 1 In the **Paths & Targets** browser, select the targets to rename.
To rename all targets in one or several paths, select the paths that contain the targets.
- 2 Click **Rename targets** to bring up a dialog box.
- 3 In the **Target Prefix** box, enter a text string to precede the target numbers.
- 4 Optionally, in the **Increment** box and the **Start with** box, change the numbering series for the target names.
- 5 Optionally, in the **Target Suffix** box, enter a text string to follow the target numbers.
- 6 Click **Apply**.

14.42 Reverse Path

Both target sequence and move instructions are reversed in a way that corresponds to recording the robot movements and playing the movie backwards. For example, if the robot used a linear motion to move from a target, it will use a linear motion to move to the target after the reversal.



xx050047

Note that the move instructions have changed together with the targets. For example, in the original path, a joint motion was used to reach target 20 and a linear motion to leave it. After the reversal there is a linear motion to the target and joint motion from it.

Also, note that the joint target has been converted into an ordinary target; otherwise, it would not be possible to program a linear motion to that position.



Note

Reverse path feature is available for paint events.

14.43 Rotate

Rotating an item

- 1 Select the item you want to rotate.
- 2 Click **Rotate** to bring up a dialog box.
- 3 Select the reference coordinate system you want to use:

If you want to move the item	Select
absolute in the coordinate system of the station	World
relative to the coordinate system of its parent	Parent
relative to its own coordinate system	Local
relative to the user-defined system	UCS
relative to an axis defined by two points	User defined axis
relative to a target reference frame Note that this option is available only for targets.	Target Reference Frame

- 4 Specify the rotation of the item in the **Rotate around x, y, z** by first clicking in one of the boxes, and then click the center position in the graphics window to transfer the values.
- 5 If you have selected the coordinate system **User defined axis**, specify the **Axis start point x, y, z** and the **Axis end point x, y, z**.
- 6 Specify the **Rotation** of the item and the axis around which the rotation is to occur.
- 7 Click **Apply**.

14.44 Rotate Path

Rotating a paths

- 1 In the **Layout** browser or the graphics window, select the paths to rotate.
- 2 Click **Rotate path** to bring up a dialog box.
- 3 In the **Reference frame** list, select the frame to rotate the paths around.

Select	To
World	rotate around the station's world coordinate system
Baseframe	rotate around the robot's baseframe
UCS	rotate around a frame or target that previously has been set to User Coordinate System.
Select Frame	rotate around an existing target or frame other than the listed ones. When using Select Frame , specify the frame to rotate around further down.

- 4 If **Selected frame** was selected in the **Reference frame** list, specify a frame or target in the text box by clicking in the box and then selecting the frame in the graphics window.
- 5 With the **Rotation axis** options, select the axis of the frame to rotate around.
- 6 In the **Rotation angle** box, enter the rotation.
- 7 Click **Apply**.

14.45 Set Local Origin

Setting the origin of the local coordinate system

- 1 If the object you want to modify is a library component, first disconnect it from the library.
- 2 In the **Layout** browser or the graphics window, select the part to modify.
- 3 Click **Set Local Origin** to bring up a dialog box.
- 4 In the **Set Local Origin** dialog box, select the reference coordinate system you want to use:

If you want to move	Select
relative to the part's current local coordinate system	Local
relative to the coordinate system of its parent	Parent
absolute in the coordinate system of the station	World
relative to a user-defined coordinate system	UCS

- 5 In the **Position X, Y, Z** boxes, either type the new position or, click to select it in one of the value boxes and then click the point in the **Graphics** window.
- 6 Type the **Orientation**.
- 7 Click **Apply**.

14 Context menus

14.46 Set Normal to Surface

14.46 Set Normal to Surface

Setting the target orientation normal to a surface

- 1 In the **Paths & Targets** browser, select the target to modify.
- 2 Click **Set Normal To Surface** to bring up a dialog box.
- 3 On the **Selection Level** toolbar, set the selection level.
 - To align the target to a specific surface, set the selection level to **surface**.
 - To align the target to a specific point at the surface, set the selection level to **part**.
- 4 In the graphics window, click the reference surface. This will transfer the name of the part or surface to the **Surface** box.
- 5 In the **Approach Direction**, click the button for the axis to be used as the approach direction.
- 6 To set the distance between the surface and the target in the approach direction, specify an **Offset** value.
- 7 Click **Apply**.

14.47 Set Position

Positioning an item

- 1 Right-click the item you want to move.
- 2 Click **Set Position** to bring up the **Set Position** dialog box.
- 3 In the dialog box, select the reference coordinate system you want to use:

If you want to move the item	Select
relative to its own coordinate system	Local
relative to the coordinate system of its parent	Parent
absolute in the coordinate system of the station	World
relative to a user-defined coordinate system	UCS
relative to a target reference frame	Target Reference Frame This option is available only for targets.

- 4 In the **Position X, Y, Z** boxes, either type the new position, or select it by first clicking in one of the value boxes and then clicking the point in the graphics window.
- 5 Specify the **Orientation** for the item.
- 6 Click **Apply**.

14.48 Tool Compensation

Offsetting a path to compensate for tool radius

- 1 In the **Paths&Targets** browser or the graphics window, select the path.
- 2 Click **Tool Compensation** to bring up a dialog box.
- 3 In the **Distance** box, enter the size of the compensation (normally, the tool radius).
- 4 Using the **Direction** options, select whether the new path shall be on the left or the right side of the current path.
- 5 Click **Apply**.



Note

Tool Compensation function supports only planar paths. In planar paths, the targets are in the same plane. User will be notified when a selected path is non-planar.

14.49 Translate Path

Translating a path

- 1 In the **Paths&Targets** browser or the graphics window, select the paths to translate.
- 2 Click **Translate path** to bring up a dialog box.
- 3 In the **Reference frame** list, select the coordinate system to use as reference for moving the paths.

Select	To
World	move relative to the origin of the world coordinate system
Base Frame	move relative to the origin of the robot's baseframe
UCS	move relative to the origin of a frame or target that previously has been set to User Coordinate System.
Select Frame	move relative to the origin of an existing target or frame other than the listed ones. When using Select Frame , specify the frame to use further down.
Point to Point	move the path from one point to another without specifying any coordinate system.

- 4 If **Select frame** was selected in the **Reference frame** list, specify a frame or target in the text box by clicking in the box and then selecting the frame from the graphics window.
- 5 In the **Translation vector** box, specify the distance to move the path along the X, Y and Z axes of the reference frame.
 Translation vector is applicable only if a reference frame is used. If **Point to Point** is used as reference, specify the start and end points for the translation, instead. To do this, click in one of the boxes for the point to specify and then select the point in the graphics window, or type the coordinates of the point.
- 6 Click **Apply**.

14 Context menus

14.50 View Robot at Target

14.50 View Robot at Target

Viewing a robot at a target

- 1 Click **View Robot at Target**.
- 2 Select a target, either in the **Paths&Targets** browser or in the graphics window.
- 3 The robot will be shown at each selected target whenever a target is selected. By stepping through the targets in the browser, it will be easy to see how the position of the robot changes.
- 4 To turn the function off, click the command again.

14.51 View Tool at Target

Viewing a tool at a target

- 1 Click **View Tool at Target** and select the tool you want to view at the target.
- 2 Select a target, either in the **Paths&Targets** browser or in the graphics window. You can also multiselect targets to show several copies of the tool. A copy of the tool will be shown at the selected target. By stepping through the targets in the browser, it is easy to see how the tool orientation changes.
- 3 To turn the function off, click the command and clear the check box.

This page is intentionally left blank

15 ScreenMaker tab

15.1 Introduction to ScreenMaker

What is ScreenMaker?

ScreenMaker is a tool in RobotStudio for developing custom screens. It is used to create customized FlexPendant GUIs without learning Visual Studio development environment and .NET programming.

Why use ScreenMaker?

A customized operator interface on the factory floor is the key to a simple robotic system. A well-designed custom operator interface presents the right amount of information at the right time and in the right format to the user.

GUI concepts

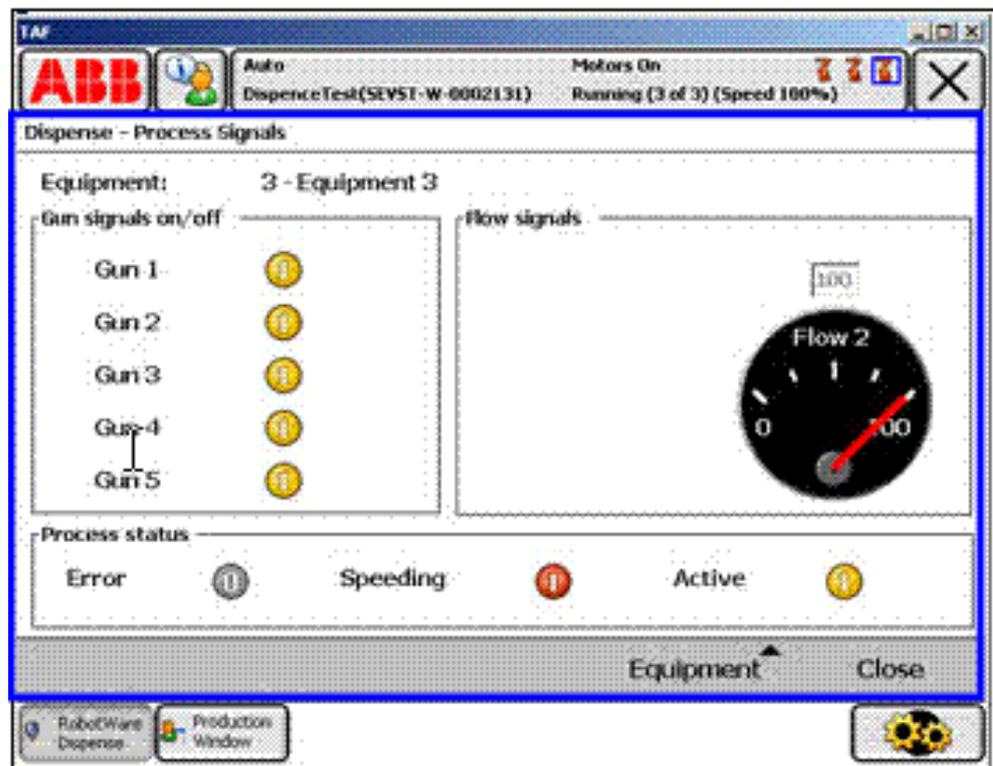

xx080000226

A GUI makes it easier for people to work with industrial robots by presenting a visual front end to the internal workings of a robotic system. For FlexPendant GUI applications, the graphical interface consists of a number of screens, each occupying the user window area (the blue box in the figure above) of the FlexPendant touch screen. A FlexPendant screen is then composed of a number of smaller graphical components in a design layout. Typical controls (sometimes referred as widgets or graphic components) include buttons, menus, images, and text fields.

Continues on next page

15 ScreenMaker tab

15.1 Introduction to ScreenMaker

Continued

A user interacts with a GUI application by:

- Clicking a button
- Selecting from a menu
- Typing a text in a text box
- Scrolling

An action such as clicking a button is called an event. Whenever an action is performed, an event is sent to the GUI application. The exact content of an event is solely dependent on the graphic component itself. Different components trigger different types of events. The GUI application responds to the events in the order generated by the user. This is called event-driven programming, since the main flow of a GUI application is dictated by events rather than being sequential from start to finish. Due to the unpredictability of the user's actions, one major task in developing a robust GUI application is to ensure that it works correctly no matter what the user does. Of course, a GUI application can, and actually does, ignore events that are irrelevant.

The event handler holds sets of actions to be executed after an event occurs. Similar to trap routines in the RAPID program, the event handler allows the implementation of application-specific logic, such as running a RAPID program, opening a gripper, processing logic or calculating.

In summary, from a developer's point of view, a GUI consists of at least two parts:

- *the view part*: layout and configuration of controls
- *the process part*: event handlers that respond to events

Modern GUI development environments often provide a form designer, a (What You See Is What You Get) WYSIWYG tool to allow the user to select, position and configure the widgets. As for event handlers, typically the developer must use a special programming language recommended by the development environment.



Note

ScreenMaker does not support Undo/Redo operations.

Continues on next page

FlexPendant concepts



xx080000228

Running Windows CE, the ABB FlexPendant has limited CPU power and memory compared to a PC. A custom GUI application must therefore be placed in the designated folders on the controller hard drive before being loaded. Once loaded, it can be found in the ABB menu as seen in the figure above. Click the menu item to launch the GUI application.

As the robot controller is the one actually controlling the robot and its peripheral equipment by executing a RAPID program, a GUI application needs to communicate with the RAPID program server to read and write RAPID variables and set or reset I/O signals.

It is essential for RAPID programmers to understand that there are two different levels controlling a work cell: an event-driven GUI application running on the FlexPendant, and a sequential RAPID program running in the controller. These reside on different CPUs and use different operating systems, so communication and coordination are important and must be carefully designed.

Limitations

ScreenMaker supports English language when building the application in RobotStudio. ScreenMaker Designer does not provide a localization tool. Therefore, applications created with ScreenMaker display the same text specified at the design time, regardless of the choice of language on the FlexPendant.

When Asian languages are used (Chinese, Japanese, Korean), these screens display accurately only when the FlexPendant language matches with the the ScreenMaker language. Otherwise empty markers will be displayed instead of text characters.

15 ScreenMaker tab

15.2 Development environment

15.2 Development environment

Overview

This section presents an overview of the ScreenMaker development environment for creating user screens.

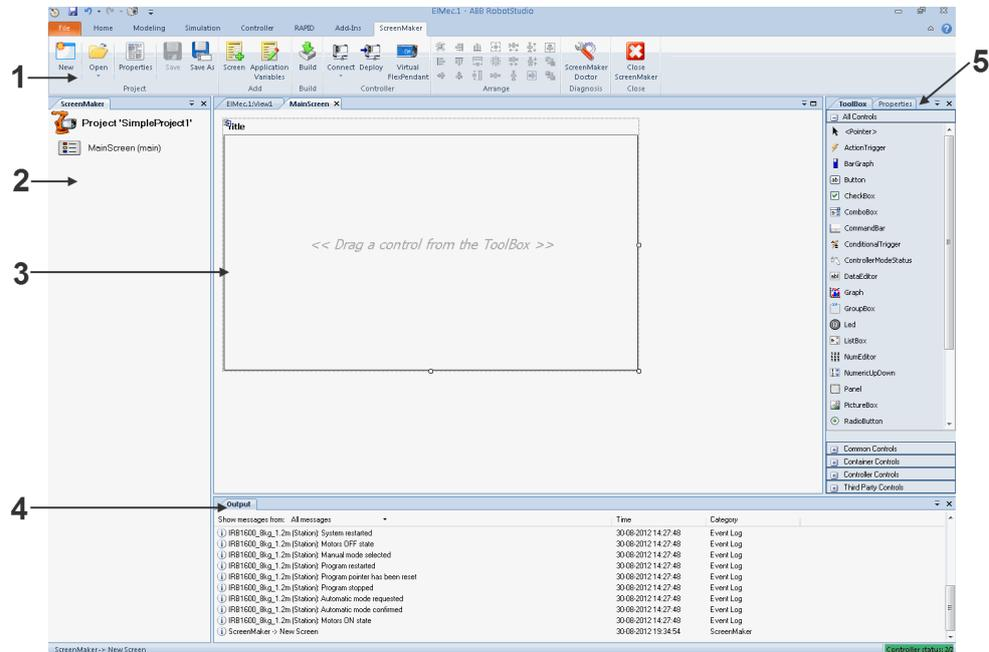

en090000584

	Parts	Description
1	Ribbon	Displays group of icons organized in a logical sequence of functions. See Ribbon on page 545 .
2	Project explorer	Shows the active screen project and lists the screens that are defined in the project. For more information, see Managing projects on page 549 .
3	Design area	Layout to design the screen with the available controls.
4	Output window	Displays information about the events that occur during ScreenMaker development.
5	ToolBox / Properties	Displays a list of available controls. For more information, see ToolBox on page 546 . Contains the available properties and events of the selected control(s). The value of the properties can either be a fixed value or a link to an IRC5 data or an Application Variable. For more information, see Properties window on page 548 .

Continues on next page

Ribbon

The ScreenMaker tab contains groups of commands organized in a logical sequence of functions that facilitates the user in managing ScreenMaker projects. The tab consists of the following groups:

Group	Functions used for
Project	Managing a ScreenMaker project. See Managing projects on page 549 .
Add	Adding screen and application variables. See Managing screens and Managing application variables on page 568 .
Build	Building a project. See Building a project on page 561 .
Controller	Connecting and deploying to the controller. See Connecting to controller on page 560 and Deploying to controller on page 561 . Also for opening the Virtual FlexPendant.
Arrange	Re-sizing and positioning the controls on the design area. See Arrange on page 545 .
Diagnosis	Detecting problems in the project and providing a diagnostic solution. See ScreenMaker Doctor on page 572 .
Close	Closing a project.

Arrange

This toolbar displays icons for resizing and positioning controls on the design area. The icons are enabled once you select a control or group of controls on the design area.



en0900000592

Continues on next page

15 ScreenMaker tab

15.2 Development environment

Continued

ToolBox

ToolBox acts a container for holding all the available controls that can be placed on a screen.

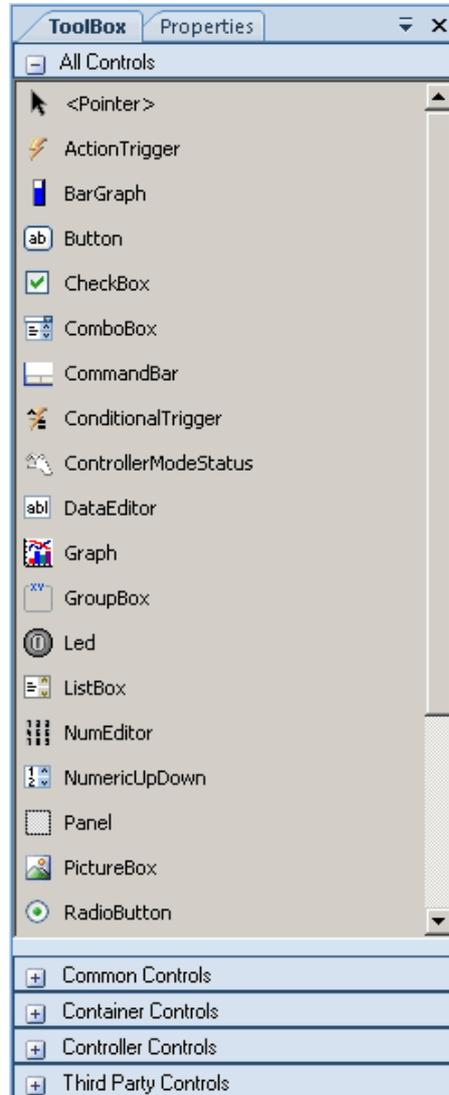

en0900000407

The following table displays the GUI controls that can be dragged to the design area.

Control	Description
ActionTrigger	Allows to run a list of actions when either a signal or rapid data changes
BarGraph	Represents an analog value in a bar
Button	Represents a control that can be clicked. Provides a simple way to trigger an event, and is commonly used to execute commands. It is labeled either with text or an image.
CheckBox	Allows multiple selections from a number of options. They are displayed as a square box with white space (for unselected) or as a tick mark (for selected).

Continues on next page

Control	Description
ComboBox	Represents a control that enables to select items from a list Combination of a drop-down list and a textbox. It allows you to either type a value directly into the control or choose from the list of existing options. It is not possible to add I/O signals to the combobox/listbox control.
CommandBar	Provides a menu system for a ScreenForm
ConditionalTrigger	Allows to define conditions while defining action triggers. An action is triggered, if there is any change in value of the data bound.
ControllerModeStatus	Displays the mode of the Controller (Auto - Manual)
DataEditor	Represents a text box control that can be used to edit the data.
Graph	Represents a control that plots data with lines or bars.
GroupBox	Represents a Windows control that displays a frame around a group of controls with an optional caption. Is a container used to group a set of graphic components. It usually has a title at the top.
LED	Displays a two states value, like a Digital Signal.
ListBox	Represents a control to display a list of items. Allows the user to select one or more items from a list contained within a static, multiple line text box.
NumEditor	Represents a text box control that can be used to edit a number. When the user clicks it, a Numpad is opened. It is not recommended to add a NumEditor in a container control.
NumericUpDown	Represents a spin box that displays numeric values.
Panel	Used to group collection of controls.
PictureBox	Represents a picture box control that displays images.
RadioButton	Allows to select only one of a predefined set of options.
RapidExecutionStatus	Displays the execution status of the Controller Rapid Domain (Running - Auto)
RunRoutineButton	Represents a Windows button control that calls a RapidRoutine when clicked
Switch	Displays and lets change a two states value, like a Digital Output Signal.
TabControl	Manages a set of tab pages.
TpsLabel	Very commonly used widget that displays text, a label is usually static, that is, it has noninteractivity. A label generally identifies a nearby text box or other graphic component.
VariantButton	Used to change the values of RAPID variables or Application variables.

**Note**

For more information on using these controls and their properties, see the section [Development environment on page 544](#) and the chapter *Using the FlexPendant SDK* of the *Application manual - FlexPendant SDK*.

Continues on next page

15 ScreenMaker tab

15.2 Development environment

Continued

Properties window

A control is characterized by its properties and events. Properties describe the appearance and behavior of the component, while events describe the ways in which a control notifies its internal state change to others. By changing the value of a property, the controls have a different look and feel, or exhibit different behavior.

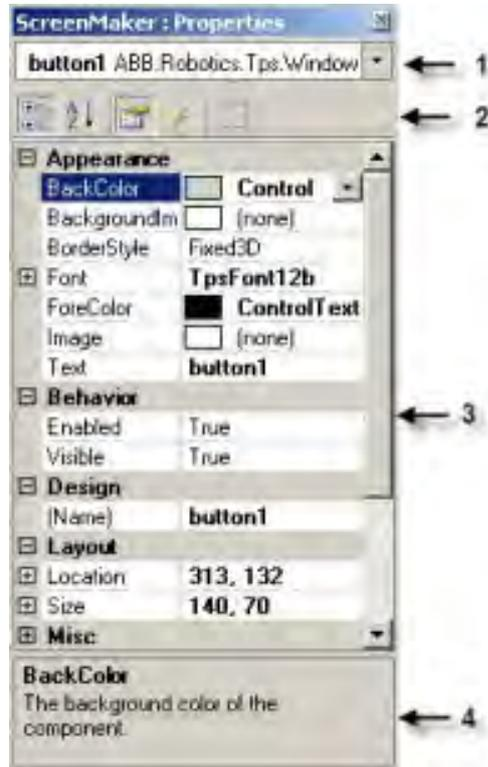

en0900000408

	Element	Description
1	Graphical component name panel	Displays the selected component, and lists the available components of the active design screen.
2	Properties window toolbar	 <p>en0900000409</p> <ul style="list-style-type: none"> 1 Organizes table panel in categories 2 Organizes table panel alphabetically 3 Displays Properties in table panel 4 Displays Events in table panel
3	Table panel	Displays all the properties or events in two-columns. The first column shows the property or event name, the second shows the value of the property or name of the event handler.
4	Information panel	Display information about a property or event.

15.3 Working with ScreenMaker

15.3.1 Managing projects

Overview

This section describes how to manage projects in ScreenMaker. A complete cycle includes creating, saving, building, connecting, and deploying a ScreenMaker project.

You can manage a project (create, delete, load, or save) either from the ScreenMaker ribbon or the context menu.

Creating a new project

ScreenMaker does not support Unicode characters. Hence, do not use these characters when you create a ScreenMaker project.

Use the following procedure to create a new project:

- 1 Click **New** from the ScreenMaker ribbon or right-click **Project** context menu and select **New Project**.

The **New ScreenMaker Project** dialog box appears.



Note

You can create a new project either from *ScreenMaker installed templates* or *ScreenMaker custom templates*.

- 2 To create a new project from the *ScreenMaker installed templates*,
 - a Click *Simple Project*.
 - b Enter a name and specify the location for the new project. By default, the new project is saved on *C:\My Documents\RobotStudio\My ScreenMaker Projects*.
 - c Click **OK**.
 - d A screen *MainScreen(main)* is added in the tree view.
- 3 To create a new project from the **ScreenMaker custom templates**,
 - a Click **Basic**, *Standard*, or **Extended**.
 - b Enter a name and specify the location for the new project. By default, the new project is saved on *C:\My Documents\RobotStudio\My ScreenMaker Projects*.
 - c Click **OK**.



Note

- If you select the template **Basic**, a project with two screens are created.
- If you select the template **Standard**, a project with four screens are created.
- If you select the template **Extended**, a project with six screens are created.

Continues on next page

15 ScreenMaker tab

15.3.1 Managing projects

Continued

Loading a project or template

Use this procedure to load an existing project or an existing template:

- 1 Click **Open** from the ScreenMaker ribbon or right-click **Project** context menu and select **Open Project**.

The **Open Screen Project File** dialog box appears.



WARNING

A warning message appears when you open an existing ScreenMaker project where the FlexPendant SDK version is different from the version the project was created.

- 2 Browse to the location of the project file or template file to be loaded and click **Open**.



Note

You can also load an existing project using a quick access method.

- 1 Click **Recent** from the ScreenMaker ribbon or right-click **Project** context menu and select **Recent Projects**.
- 2 Select the project file from the list of most recently opened projects.

Saving a project

To save a project or template, follow this step:

- Click **Save** from the ScreenMaker ribbon or right-click **Project** context menu and select **Save**.

To save the existing project or template with a new name, follow this step:

- Click **SaveAs** from the ScreenMaker ribbon or right-click **Project** context menu and select **SaveAs**.



Note

- Project files are saved with the extension **.smk*.
- Template files are saved with the extension **.smt*.

SaveAs FlexPendant Project

To save the ScreenMaker project as a FlexPendant project, in the project context menu, click **SaveAs FlexPendant Project**.

The project is saved with the extension **.csproj* which can be opened using Microsoft Visual Studio 2008.

Continues on next page

Designing screens

This section describes adding, copying, renaming, deleting, and editing a screen.

Overview

The Form designer is a tool to edit or design a screen. It allows you to design the screen with the required controls and the design area resembles a FlexPendant screen.

Editing a screen

To edit a screen, follow these steps:

- 1 Drag a control from the toolbox and drop it on the design area.
The **Properties** window displays all the properties of the control.
- 2 Select the control and resize or reposition for configuration.



Note

You can either select a single control or multiple controls:

- **Single control** : Left-click the control on the design area or select the control from the list in the Properties window.
- **Multiple controls**: Left-click on the design area, drag the mouse and create a window selecting all the controls.

- 3 Click the smart tag on the upper right corner of the control to perform the basic tasks of configuration. See [Configuring data binding on page 569](#).



Note

You can perform additional configuration by editing the attributes in the Properties window. See [Properties window on page 548](#).

Using ScreenMaker controls

This section describes building the GUIs using the following controls from the ToolBox.

ActionTrigger

An action trigger initiates an event, such as making a hidden object visible when an action is performed using a control. It allows to run a list of actions when the property value changes. The property value can be bound to a signal, rapid data, or application variable.

ActionTrigger control can also be used to invoke the application from RAPID.

Use this procedure to add an ActionTrigger control::

	Action
1	Drag an <i>ActionTrigger</i> control from the ToolBox on to the design area.

Continues on next page

15 ScreenMaker tab

15.3.1 Managing projects

Continued

	Action
2	<p>You can modify the name, set the default value and configure data binding value for a ActionTrigger control.</p> <ul style="list-style-type: none">• To set the values of a property, see Properties window on page 548.• You can set the trigger event for an ActionTrigger to any of the event handler created either from a control or from an Events Manager option.• To configure the data binding values, see Configuring data binding on page 569.• To set the application variables, see Managing application variables on page 568.



Note

An action is not triggered when the screen is launched for the first time, but is triggered when there is a difference in the bound value at any point of time. This functionality is supported only in RobotWare 5.12.02 or higher.

Example: Consider a signal being bound to the value property. The value of the signal changes at runtime on performing a specific action. The event handler configured for ActionTrigger control gets triggered based on this signal value change.

TpsLabel

TpsLabel is a standard Windows label that displays a descriptive text.

Use this procedure to add a TpsLabel control:

Step	Action
1	Drag a TpsLabel control from the ToolBox on to the design area.
2	<p>You can set the values, setup events, configure data binding values and set the application values for a TpsLabel control.</p> <ul style="list-style-type: none">• To set the values of a property, see Properties window on page 548.• To set up the events, see Defining Events on page 556.• To configure the data binding values, see Configuring data binding on page 569.• To set the application variables, see Managing application variables on page 568.
3	<p>You can set the option Allow Multiple States to true and change the property.</p> <ol style="list-style-type: none">1 Click Allow Multiple States. The StatesEditor dialog box appears.2 Click the check-box Allow Multi-States, select the properties to change from Properties For States and click OK.

The controls Button, PictureBox, and TpsLabel support AllowMultipleStates. For more information on how to use AllowMultipleStates, see [Picture object and changing images due to I/O on page 575](#).

Panel

Panel is used to group a collection of controls.

Use this procedure to add a Panel control:

Step	Action
1	Drag a Panel control from the ToolBox on to the design area.
2	You can add a group of controls to a panel.

Continues on next page

Step	Action
3	You can modify the name, set the default value and binding value for a Panel control. <ul style="list-style-type: none"> To set the values of a property, see Properties window on page 548. To set up the events, see Defining Events on page 556. To configure the data binding values, see Configuring data binding on page 569. To set the application variables, see Managing application variables on page 568.

**Note**

Currently only EventHandler, CancelEventHandlers, and MouseEventArgs are supported.

ControllerModeStatus

ControllerModeStatus displays the mode of the controller (Auto - Manual).

Use this procedure to add a ControllerModeStatus control:

Step	Action
1	Drag a ControllerModeStatuscontrol from the ToolBox on to the design area.
2	You can set the values, setup events, configure data binding values, and set the application variables for a ControllerModeStatus control. <ul style="list-style-type: none"> To set the values of a property, see Properties window on page 548. To set up the events, see Defining Events on page 556. To configure the data binding values, see Configuring data binding on page 569. To set the application variables, see Managing application variables on page 568.
3	You can select the image to be displayed when the controller is in Auto mode and in Manual mode. <ul style="list-style-type: none"> Click AutoImage in the Properties window and browse to select the image to be displayed in Auto mode. Click ManualImage in the Properties window and browse to select the image to be displayed in Manual mode.

RapidExecutionStatus

RapidExecutionStatus displays the execution status of the Controller Rapid Domain (Running - Auto). This control is used

Use this procedure to add a RapidExecutionStatus control:

Step	Action
1	Drag a RapidExecutionStatus control from the ToolBox on to the design area.
2	You can set the values, setup events, configure data binding values, and set the application values for a RapidExecutionStatus control. <ul style="list-style-type: none"> To set the values of a property, see Properties window on page 548. To set up the events, see Setup Events. To configure the data binding values, see Configuring data binding on page 569. To set the application variables, see Managing application variables on page 568.

Continues on next page

15 ScreenMaker tab

15.3.1 Managing projects

Continued

Step	Action
3	You can select the image to be displayed when the Program is running and is stopped. <ul style="list-style-type: none">• Click RunningImage in the Properties window and browse to select the image to be displayed when the Program is running.• Click StoppedImage in the Properties window and browse to select the image to be displayed when the Program is stopped.

RunRoutineButton

RunRoutineButton represents a Windows button that calls a RapidRoutine when clicked.



Note

To call a routine containing movements, you are not recommended to use the RunRoutine Button control. Instead use a normal button control to call a Trap routine. In the Trap routine, use instructions such as StopMove, StorePath, RestorePath and StartMove to control the movements of the robot.

Use this procedure to add a RunRoutineButton control:

Step	Action
1	Drag a RunRoutineButton control from the ToolBox on to the design area.
2	Click the smart tag on the RunRoutineButton and select one of the following RunRoutineButtonTasks. <ul style="list-style-type: none">• Define Actions before calling Routine• Select Routine to call• Define Actions after calling Routine
3	Click Define Actions before calling Routine to define an action/event before calling the routine. The Events Panel dialog box appears.
4	Click Define Actions after calling Routine to define an action/event after calling the routine. The Events Panel dialog box appears.
5	Click Select Routine to call. The Controller Object Binding dialog box appears.
6	In the Properties window, set the value for the following properties: <ul style="list-style-type: none">• RoutineToCall - Set the routine to be called. Indicates the RAPID Routine that will be called when this button is pressed.• AllowInAuto - Set to True or False. Indicates if the routine could be called in the Auto mode.• TextAlign - Set to MiddleLeft and MiddleCenter. Indicates the text alignment. Note the following restrictions: <ul style="list-style-type: none">• You cannot bind RunRoutineButton to built-in Service routines.• Only user defined procedures with no arguments can be bound.• Set the PP to task before performing action through RunRoutineButton.

Continues on next page

CommandBar

CommandBar allows you to add menu items in a controlled and organized order. Use this procedure to add menu items to the CommandBar control:

Step	Action
1	Drag a CommandBar control from the ToolBox on to the design area. The CommandBar appear at the bottom of the screen.
2	Click the smart tag on the CommandBar and select Add/Remove Items. The MenuItem Collection Editor window appears.
3	Click Add. A new menu item is added and its properties are displayed which can be edited. Note that while editing the menu item, ensure that the property Text is filled. If not, nothing appears on the CommandBar.
4	To remove the menu item, select the menu item and Click Remove.
5	Click Close to close the MenuItem Collection Editor window.

To add an event to a menu item, for example *menuItem1* on the command bar, use this procedure:

Step	Action
1	Go to the Properties window and select <i>menuItem1</i> from the drop-down list.
2	Click Events icon and then double-click the Click event. This opens the Events Panel dialog for the Click event.
3	Click Add Action from the Events Panel dialog. This opens a sub-list of actions.
4	Click an action from the sub-list of actions to add it to <i>menuItem1</i> 's Click event.

**Note**

ScreenMaker does not support the FlexPendant controls feature to add sub menu items on CommandBar.

VariantButton

The VariantButton control is a simple button control with additional features and properties. Using this control, you can change the values of RAPID or Application variables.

Use this procedure to add the VariantButton control:

Step	Action
1	Drag a VariantButton control from the ToolBox on to the design area.
2	You can perform the following VariantButton tasks from the SmartTag: <ul style="list-style-type: none"> • Define Actions before value change • Define Actions after value change

Continues on next page

15 ScreenMaker tab

15.3.1 Managing projects

Continued

Step	Action
3	<p>You can set the following VariantButton specific properties from the Properties window:</p> <ul style="list-style-type: none">• Select Increment or Decrement from Behavior drop down. The default behavior of VariantButton is Increment.• Select StepRate and set the rate at which the value must be varied.• Select DataType to which the value should be bound and set the value property of the selected datatype. <p>Supports only the RAPID datatypes, Num and Dnum. For more information on data binding, see Configuring data binding on page 569.</p>
4	<p>You can also perform the following common tasks from the Properties windows:</p> <ul style="list-style-type: none">• Set BackColor, ForeColor, Location, and Size of the control.• Select True or False from the Visible dropdown to hide or unhide the control.• Select True or False from the Enabled drop down to enable or disable the control.

ConditionalTrigger

The ConditionalTrigger button defines the condition while defining action triggers. An action will be triggered if there is a change in the value of the data bound.

Use this procedure to add the ConditionalTrigger control:

Step	Action
1	Drag a ConditionalTrigger control from the ToolBox on to the design area.
2	<p>You can set the following ConditionalTrigger properties from the Properties window:</p> <ul style="list-style-type: none">• Select the condition to execute from the Condition drop down. The following are the supported conditions AND, OR, XOR, NOT, and EQUAL.• Select True or False from the Enabled drop down to enable or disable the control.• Select LHS and RHS and bind the data value to Controller Object or Application Variable. For more information on data binding, see Data binding on page 569.

Defining Events

Event handler is a set of actions to be executed after an event occurs.

To set up an event, follow these steps:

- 1 Select the control for which the event handler is to be defined.
- 2 Open the **Events Panel** dialog box in any one of the following ways:
 - Double-click the control.
 - Right-click the control, select **Events Manager**, click **Add** enter the name, and click **OK** and close.
 - Click smart tag and select the task from the list.
 - In the **Properties** window, click **Events** icon and select the desired event from the list.
- 3 Click **Add Action** to add an action from a predefined list of actions.

The following table lists the set of predefined actions:

Screens	<ul style="list-style-type: none">• Open Screen• Close Screen
---------	--

Continues on next page

Signals	<ul style="list-style-type: none"> • Set a Digital Signal • Invert a Digital Signal • Pulse a Digital Signal • Read a Signal • Write a Signal • Reset a Digital Signal
RapidData	<ul style="list-style-type: none"> • Read a Rapid Data • Write a Rapid Data
Application Variable	<ul style="list-style-type: none"> • Read and Write
Advanced	<ul style="list-style-type: none"> • Call another Action list • Call .NET method • Call Custom Action • Call FP Standard View

- 4 Select the action from the left window and perform the following:
 - Click **Delete** to delete the action.
 - Click **Move Up** or **Move Down** to change the order of execution of actions.
- 5 Click **OK**

Deleting an event handler

To delete a user created event handler, do the following:

- 1 Right-click the control, select **Events Manager**. The **Events Manager** dialog box appears.
- 2 Select the event handler to be deleted from the list and click **Delete**.

Advanced Actions

Call another Action List

Existing event handlers from Events Manager can be reused by other controls while defining actions for event. You can call another event handler from an existing event handler.

In the following example, `listbox1_SelectedIndexChanged` event handler is called from `comboBox1_SelectionIndexChanged` event handler.

Select the *Show warning message before performing actions* check box to have a warning displayed before you can perform these actions.

Call .NET Method

You can import the dlls and add references to the *Advanced* tab of the **Project Properties** dialog box.

Once the references are defined, .NET methods appear in the *Project Properties* dialog box and can be included in the *Actions* list which will be executed on performing the desired action.

The .NET assembly supports only public static methods.

Double click the method and bind the return value to the application variable.

Continues on next page

Binding can be done only to the application variable. For more information, see [Application variable data binding on page 571](#).



Note

ScreenMaker allows you to call static methods of the public classes defined in another DLL. This DLL is usually a class library or a control library. It has the following limitations and the user should be aware of them while using .Net DLLs.

- DLL's references must be in the same directory in order to load the DLL.
- ScreenMaker provides access only to the static methods which contain basic data types such as string, int, double, boolean, object.

The following procedure provides information on creating a .NET assembly. This assembly can be added as a reference to ScreenMaker Project and for performing certain computations which are not directly possible using ScreenMaker or to call methods of FlexPendant or PCSDK.

Use Visual Studio 2010 or above to create a .NET assembly.

- 1 Create a new project with Class Library as your template.
- 2 Create public static methods like the following.

```
namespace SMDotNetMethods
{
    public class Methods
    {
        /// <summary>
        /// Inverts a boolean value
        /// </summary>
        /// <param name = "Value">input boolean value</param>
        /// <returns>inverted boolean value</returns>
        public static bool InvertBool(bool value)
        {
            return (value == false);
        }

        /// <summary>
        /// Increments a numerical value
        /// </summary>
        /// <param name="value">value to be incremented</param>
        /// <returns>incremented value</returns>
        public static double Increment(double value)
        {
            return (value + 1);
        }
    }
}
```

- 3 Build the project.
- 4 Use the assembly generated from this Class Library project.
- 5 Add it as a reference to the ScreenMaker project.

Continues on next page

Call Custom Action

You can add an user control to the *ScreenMaker toolbox* and call a custom method for that control by defining it in the *ScreenMaker.dll.config file*.

Call Custom Action supports only the Graph control.

Call FP Standard View

Standard FlexPendant screens can be opened on any action performed on the control. The standard FlexPendant screens include Rapid Editor, Rapid Data, LogOff, Jogging, Backup and Restore.

For example, on button1_click, Rapid Editor view is opened.

Editing the property value

You can edit the property value of a control from the *Properties window* in three ways:

- 1 By typing the numerics, strings and text. For example, Location, Size, Name etc.
- 2 By selecting the predefined values from the list. For example, BackColor, Font etc.
- 3 By entering the values in the dialog box. For example, Enabled, States, BaseValue etc.

Deleting an event handler

To delete a user created event handler, do the following:

- 1 Right-click the control, select **Events Manager**. The **Events Manager** dialog box appears.
- 2 Select the event handler to be deleted from the list and click **Delete**.

Modifying Project properties

Project properties define the properties of the ScreenMaker project, including how the GUI is loaded and displayed in the FlexPendant.

Use this procedure to modify the project properties:

- 1 Right-click **Project** context menu and select **Properties**.
The **Project Properties** dialog box appears.
- 2 In the **Display** tab under **Caption**, enter the text in the **Caption of the Application** field to edit the caption.
The updated caption appears in the **ABB Menu** on the right side.
- 3 In the **Display** tab under **ABB Menu**, select the following options,

Option	Description
Left	application is visible to the left in the ABB Menu.
Right	application is visible to the right in the ABB Menu.
None	application is not visible at all in the ABB Menu.

Continues on next page

15 ScreenMaker tab

15.3.1 Managing projects

Continued



Note

The applications that uses the option **None** cannot be run on RobotWare releases earlier than 5.11.01.

- 4 In the **Display** tab under **ABB Menu**, browse and select the **ABB menu image**.
- 5 In the **Display** tab under **TaskBar**, browse and select the **TaskBar image**.



Note

By default, the **Use Default Image** and **Use Menu Image** checkbox is enabled and the default image *tpu-Operator32.gif* is selected.

- 6 In the **Display** tab under **Startup**, select **Automatic** to load the screen automatically at the Startup.



Note

By default, the start up type is **Manual**.

- 7 In the **Advanced** tab under **Run Settings**, select **Launch virtual FlexPendant after deploying** checkbox.

The virtual FlexPendant will be launched after deploying the ScreenMaker project to the virtual controller.



Note

This feature is not applicable if connected to a real controller.

- 8 In the **Project Properties** dialog, select the **General** tab to view the project properties which includes, **Name**, **Assembly**, **Version** and **Path**.

Version displays the specific versions of Controller and FlexPendant SDK that the ScreenMaker project uses.

Connecting to controller

Use this procedure to connect to both real and virtual controllers:

- 1 Click **Connect** from the ScreenMaker ribbon or right-click **Project** context menu and select **Connect**.

The **Select a Robot Controller** dialog box appears.



Note

Click the **Connect** dropdown from the ScreenMaker ribbon to directly connect to the controller.

Continues on next page

- 2 Click **Refresh** to find a list of all the available controllers.



Note

By default, the currently connected controller is highlighted and has a small icon before the row as an indicator.

- 3 Select the controller to be connected from the list and click **Connect**.
The connection status is displayed in the Project tree view.

To remove the connection with the controller, click **Disconnect** from the Project context menu.

Building a project

The result from building the ScreenMaker project is a set of files including DLL file and images. The ScreenMaker project can be compiled into binary format (.dll) that can be deployed on a FlexPendant.

Use this procedure to build a project:

- 1 Click **Build** from the ScreenMaker ribbon or right-click Project context menu and select **Build**

The result is displayed in the output window.

Deploying to controller

Use this procedure to deploy a ScreenMaker project to a real controller or virtual controller:

- 1 Connect to the controller you want to deploy to. See [Connecting to controller on page 560](#).
- 2 Click **Deploy** from the ScreenMaker ribbon or right-click Project context menu and select **Deploy Screen to Controller**.

The **Download** dialog box appears displaying the progress of download. It disappears once the download is successful.

The **TpsViewxxxxx.dll** file is downloaded.

- 3 Restart the controller.



Note

- If a real controller is used, you can reboot the FlexPendant by moving its joystick three times to the right, once to the left, and once towards you.
- If a virtual controller is used, you can reboot the FlexPendant by closing the virtual FlexPendant window.

Closing a project

To close a project, follow this step:

- Right-click **Project** context menu and select **Close Project**.

Continues on next page

15 ScreenMaker tab

15.3.1 Managing projects

Continued

Closing ScreenMaker

To close ScreenMaker, follow this step:

- Click **Close ScreenMaker** from the ScreenMaker ribbon.

Managing ScreenMaker Widgets

What is a widget

A widget is a visual building block, containing an information arrangement, which represents an aspect of a robot application. It is a reusable and sharable user interface building block which can help speed up the development of screens.

A ScreenMaker widget is similar in function to the widgets used in computer programming. The widget is an element of a graphical user interface (GUI) that displays an information arrangement which is changeable by the user. The widgets, when combined in an application, hold data processed by the application and the available interactions on this data.

Widget Workflow

Widget created from ScreenMaker can be used in ScreenMaker application and in Production Screen application.

The following are the steps required to create a Widget in ScreenMaker.

- 1 Start RobotStudio.
- 2 Launch ScreenMaker.
- 3 Create a new **Widget Project** or open an existing widget project.
For information on how to create a new widget project, see [Creating a ScreenMaker widget project on page 563](#).
- 4 Connect to a real or a virtual controller, as required.
- 5 If required, change the widget properties, using the **Widget Properties** dialog box.
For information on the Widget Properties dialog box, see [Specifying widget properties on page 566](#).
- 6 Drag-and-drop the necessary user interface components, as you would in a normal ScreenMaker project.
- 7 Link the user interface properties to the IRC5 data or to the application variables
- 8 Build the widget project. The widget component is created and saved in `...\Documents\RobotStudio\Widget Components` folder.

Sample use case

Consider a case where you want to design a production screen which can do the following:

- Display a graph
- Show alarms
- Show status of the controller

Continues on next page

To achieve this:

- 1 Create a new widget project in ScreenMaker and names it as, for example, GraphWidget.
- 2 Drags-and-drop the graph control and other necessary controls on the widget form.
- 3 Connect to a real or virtual controller, as required.
- 4 Bind the controls to the controller data.
- 5 Use the widget properties dialog box, to change the size of the widget.
- 6 Build the project
- 7 Download the output to the production screen.

You can then repeat the above steps to create widgets either in the same or in different projects based on your need to show the alarms and the status of the controller.

Creating a ScreenMaker widget project

- 1 On the ScreenMaker tab, click **New**. Alternatively, in the project context menu, click **New Project**.

The **New ScreenMaker Project** dialog box appears.

- 2 Under Widget Templates, click **Widget**.
- 3 Specify a name for the widget project.

ScreenMaker widgets projects are by default stored in the
... \Documents\RobotStudio\Widget Projects folder.

- 4 Click **Ok**.

The widget project along with a screen **MainScreen(main)**, appears in the tree view. The widget project has **.wzp** file name extension. Widgets also appear in the **Toolbox**.



Note

- You can open one widget project at any time. Close an open widget project before opening a new one.
- A widget project has only one screen, the main screen, on which the widgets are designed. All controls defined on a widget are considered as one widget.
- Widgets are loaded into the toolbox from a folder that contains the widget component DLLs, from Additional Options folder under MediaPool and from RobotApps Repository. If you delete the widget components from these locations (... \Documents\RobotStudio\Widget Components), then the widgets will not appear in the Toolbox.

Creating Production Screen Widget

ScreenMaker helps the user to create two types of widgets, Production Screen widget and Standard widget. Controls in a widget can be bound to rapid or signal data.

Continues on next page

15 ScreenMaker tab

15.3.1 Managing projects

Continued

The Production Screen option is a framework for creating a customized GUI that can be used to present process data and status and execute FlexPendant applications.

To run widgets on the Production Screen, FlexPendant Interface option must be selected. For more information on Production Screen. Use the following procedure to create the Production Screen widget.

- 1 In the **Screenmaker** ribbon, select **New**. The **New Project** dialog opens
- 2 Select **Widget Template** to create a new widget project.
- 3 Drag and drop controls to the widget.
- 4 Select **Widget Properties**, **Widget Properties** dialog opens.
- 5 Under **Type**, click **Production Screen** and click **OK**.

Continues on next page

6 Build the project.

xx140000275

The *ProductionSetup.xml* file must be updated with widget details to view the widget that was created in the Production Screen. You can find *ProductionSetup.xml* under `$System\HOME\ProdScr` and Widget components under `$System\HOME\ProdScr\tps`.

An example of widget detail is provided here:

```
<Widget>
<Name>Widget_9</Name>
<Page>1</Page>
<Assembly>Widget_9.dll</Assembly>
<Type>Widget_9.Widget_9</Type>
```

Continues on next page

15 ScreenMaker tab

15.3.1 Managing projects

Continued

```
<Position>
<X>1</X>
<Y>2</Y>
</Position>
<ZIndex>1</ZIndex>
<Bindings>
<Binding PropertyName ="led1.Value" BindingType="SIGNAL"
    DataName="MOTLMP" />
<Binding PropertyName ="button1.Text" BindingType="RAPID"
    DataName="T_ROB1/BASE/wobj0" />
</Bindings>
</Widget>
```

The production screen provides the flexibility to modify bindings of the widget. This is provided under Bindings tag as shown here:

```
<Bindings>
<Binding PropertyName ="led1.Value" BindingType="SIGNAL"
    DataName="MOTLMP" />
<Binding PropertyName ="button1.Text" BindingType="RAPID"
    DataName="T_ROB1/BASE/wobj0" />
</Bindings>
```

Specifying widget properties

To specify the properties of a widget project, right-click a widget project, and then click **Properties**. The Widget Properties dialog box appears.

You set and modify the following in the properties for the widget project:

- Name of the project
- Size of the widget - x,y (in mm)
- Select the type of Widget
 - Production Screen: The Widget can be used with Production Screen environment
 - ScreenMaker: The Widget can be used with ScreenMaker applications

Modifying Binding Information of Widget

Use this option to modify the binding information of widget. When a widget is built from the Widget Project, an xml file is created. This xml contains widget details and binding information. This entry must be available in the *Production.xml* file to work with the Production Screen Environment .

```
<Bindings>
<Binding PropertyName ="meter1.Value" BindingType="IO"
    DataName="aoMeterSignal" />
<Binding PropertyName ="meter1.Title" BindingType="RAPID"
    DataName="Flow1Title" />
</Bindings>
```

It is possible to create, use and modify the bindings of a widget created from ScreenMaker and to view the results in Production Screen and in ScreenMaker application environment.

Continues on next page

Building and Deploying

The output of the Widget Project is a single Widget Component dll file, for example, *TpsViewMyWidget.dll*. The widgets built from the Widget Project are used in the ScreenMaker project. Widgets cannot be deployed to the controller from ScreenMaker. If Widgets are used in ScreenMaker projects, it gets deployed.

When the ScreenMaker project which uses a widget is built, the widget component is added as a reference to the project.

When the ScreenMaker project output is deployed to the controller, the referenced widget components are also copied to the system *HOME* folder.

15.3.2 Application variables

Overview

Application Variables are variables defined inside a ScreenMaker application. An application variable is similar to a RAPID variable. It supports the data types supported by RAPID, such as num, dnum, string, tooldata, wobjdata, and so on. An application variable's definition includes its name, data type and initial value. During the execution of the ScreenMaker application, an application variable has a persistent value. It can store values coming from controller data or can be used to write values to controller data. Therefore, it is like an intermediate persistent variable which is used during RAPID execution along with other RAPID variables.

Managing application variables

To create, delete, and rename an application variable, follow these steps:

- 1 On the **ScreenMaker** tab, in the **Add** group, click **Application Variables**.
Alternatively, in the **ScreenMaker** browser, right-click the project, and then click **Application Variables**.
The **Project Application Variables** dialog box appears.
- 2 Click **Add** and define the name, type and value of the new variable.
- 3 Select the variable, click **Delete** to delete a variable.
- 4 Select the variable, click **Rename**, enter the new name and click **OK** to rename a variable.
- 5 Click **Close**.

You can view the application variables related to a project listed in the **Project Application Variables** dialog box. To filter and view the variables according to their data types, use the **Type** list.



Note

For information on application variable data binding, see [Data binding on page 569](#).

15.3.3 Data binding

Overview

Data binding is the mechanism that links a GUI property with an external data source such that whenever the data source is updated the GUI property will be updated automatically and vice versa. Databinding has the following three aspects:

- A *unidirectional* connection means that an update of the data source is reflected by the GUI, or vice versa; a *bidirectional* connection means that updates to either are reflected by the other.
- A *temporal* connection can be suspended and resumed at any time.
- A *convertable* connection negotiates between the different data types or formats between the data source and the GUI property.

A screen has to be linked with data to be useful. There are two ways of linking the data with the GUI properties:

- [Controller object data binding on page 570](#)
- [Application variable data binding on page 571](#)

Configuring data binding

Data binding can be configured in the following two ways:

Using smart tag

Smart tags perform basic configuration tasks like binding default GUI property with controller data. The controls that either display or edit information normally have a value property to represent the information. Smart tag binds the value to the controller object.

- On the design area, select the control and click the smart tag. The tasks menu appears.

Click...	to...
Bind Value to a Controller Object	bind data to a Controller Object. For more information, see Controller object data binding on page 570 .
Bind Value to an Application Variable	binding data to a application variable. For more information, see Application variable data binding on page 571 .

Using Binding menu

- 1 On the design area, select the control.
- 2 In the Properties window, locate the row from the table for binding the value.
- 3 Select the property and click the list to display the Binding menu.

Click...	to...
Remove actual binding	removes the existing data binding.
Bind to a Controller object	select available data in the controller for binding. For more information, see Controller object data binding on page 570 .

Continues on next page

15 ScreenMaker tab

15.3.3 Data binding

Continued

Click...	to...
Bind to an Application variable	select available data in project temporary data store for binding. For more information, see Application variable data binding on page 571 .

Configuring data binding for different controls

Almost all the controls defined in the toolbox (except ComboBox and ListBox) have the following two options for binding values:

- Bind to a Controller Object
- Bind to an Application Variable

Binding to an array can be done with the following controls:

- DataEditor
- ComboBox
- ListBox

Control	Description
DataEditor	The default index value is 1. DataEditor is designed in such a way that the default value of the Rapid array starts with 1 and not 0.
ComboBox and ListBox	The default index value is -1. You can enter the appropriate index value but cannot bind to a controller object or an application variable. Note the following: <ul style="list-style-type: none">• You can limit the number of items to be displayed in the ComboBox and ListBox of an array.• While using a ComboBox, a RAPID index starts with 1 (1 specifies the first element) and the ComboBox index starts with 0 (0 specifies the first index).• When adding items to the ListBox or ComboBox control, it is not possible to add I/O signals.

For more information on RAPID array, see [What is RAPID array on page 576](#).

Controller object data binding

Controller object data binding lets you to select the data in the controller for binding.

Use this procedure to set up a binding with controller objects:

- 1 Select **Bind to a Controller Object** either using smart tag or binding menu.
The **Controller Object Binding** dialog box appears.
- 2 In the **Type of Object** group, select either **Rapid data** or **Signal data**.
- 3 In the **Shared** group, select **Built-in data only** to access shared **Rapid data**.
When you select **Built-in data only**, the option **Signal data** and the text box **Module** are disabled.
- 4 If you select **Rapid data**, from the **Scope** group, select a task and module from the list.
When you select **Signal data**, the **Scope** group is disabled.
- 5 In the **See** list, select the desired data.

Continues on next page

**Note**

ScreenMaker supports binding to only constant and persistent variables. The variables must not be declared LOCAL. TASK PERS is supported

For example, the following binding is supported:

```
PERS num n1:=0;  
TASK PERS num n2:=0;  
CONST num n3:=0;
```

The following binding is not supported:

```
LOCAL PERS num n1:=0;  
VAR num n1:=0
```

Application variable data binding

Application variables are used for data binding in the same way as controller data. See [Controller object data binding on page 570](#).

Use this procedure to set up a binding with application variables:

- 1 Select **Bind to an Application Variable** either using smart tag or binding menu.

The **Application Variables Bind Form** dialog box appears.

- 2 Select an application variable and the field to connect.
- 3 Click **Setup Variables** to manage the variables.

The **Project Application Variables** dialog box appears. See [Managing application variables on page 568](#).

- 4 Click **OK**.

15.3.4 ScreenMaker Doctor

Overview

ScreenMaker Doctor is a diagnostic solution to detect problems in the ScreenMaker project. It helps analyze the project and fix errors such as:

- Unused events
- Broken references, application variables, signals, modules, and Rapid data
- RunRoutine issue

Using ScreenMaker Doctor

Use this procedure to launch ScreenMaker Doctor, detect and report issues, and to view causes and solutions:

- 1 In the ScreenMaker ribbon, click **ScreenMaker Doctor**.

The **ScreenMaker Doctor Wizard** opens.

- 2 Click **Next**.

The wizard starts detecting issues and are reported as **Completed Checks**. The detected issues are categorized as:

- Broken References
- Unused Events
- Broken ApplicationVariables
- Broken Signals
- Broken Modules
- Broken RapidData
- RunRoutine issue
- Broken Routine
- Other Dependencies

- 3 Click **View Causes and Solutions** to generate a report.

The left hand side of the report displays issues under each category and the right hand side of the report displays the Probable Causes and Solutions for the issues.

To check for issues again using the same instance, click **Re-Detect Issues**.



Note

In order to detect the signal data and RAPID, ScreenMaker project should be connected to the controller.

Errors fixed by ScreenMaker Doctor

The following sections show you how errors, which can be fixed by ScreenMaker Doctor, may manifest.

Unused Events

The following sequence of actions will result in creating unused events.

- 1 Create a ScreenMaker project.

Continues on next page

- 2 Define events for the controls.
- 3 Define the events *Button1_Click* and *Button2_Click* for the controls *Button1* and *Button2* respectively.
- 4 Delete the control *Button1*. The event *Button1_Click* will still exist. An unused event is created.

You can run ScreenMaker Doctor to detect and fix this error.

Broken Reference

The following sequence of actions will result in creating broken references.

- 1 Create a ScreenMaker project.
- 2 Define events for the controls.
- 3 Define the events *Button1_Click* and *Button2_Click* for the controls *Button1* and *Button2* respectively.
- 4 Define action *ScreenOpen - Screen2* for the event *Button1_Click*.
- 5 Delete or rename the screen. A broken reference is created.

You can run ScreenMaker Doctor to detect and fix this error.

Broken Application Variables

The following sequence of actions will result in creating broken application variables.

- 1 Create a ScreenMaker project.
- 2 Add an Application variable to the project.
- 3 Rename or delete the Application variable. No error is reported.

An error is reported during the run time due to the broken application variable.

You can run ScreenMaker Doctor to detect and fix this error.

Broken Rapid Data/Signals

If rapid data is bound but not found in the controller connected in the ScreenMaker project, then perform the following procedure:

- 1 Create a ScreenMaker project.
- 2 Connect to a controller.
- 3 Bind the properties of the controls with controller data.
- 4 Build the project and deploy it to the controller.
The application works.
- 5 Connect the ScreenMaker project to another controller and deploy the same project.
The application produces errors in the FlexPendant.
- 6 Run ScreenMaker Doctor. It detects that RapidData is not found in the controller, thereby suggesting to define the same.

Broken Modules

If modules are bound but not found in the controller connected in the ScreenMaker project, then perform the following procedure:

- 1 Create a ScreenMaker project.
- 2 Connect to a controller.
- 3 Bind the properties of the controls with controller data.

Continues on next page

15 ScreenMaker tab

15.3.4 ScreenMaker Doctor

Continued

- 4 Build the project and deploy to controller.
The application works.
- 5 Connect the ScreenMaker project to another controller and deploy the same.
The application produces errors in the FlexPendant.
- 6 Run ScreenMaker Doctor.
It detects that the module in which the rapid data was defined is not found in the controller, thereby suggesting to define the same. ScreenMaker doctor also detects Hidden modules.

RunRoutine Issue

A check is made whether *ScreenMaker.sys* file is loaded on the controller or not. An issue is detected if the system module is not loaded.

You can run ScreenMaker Doctor to detect and fix this error.

A *System.NullReferenceException* appears if *ScreenMaker.sys* entry is not available in *SYS.CFG* file of robot system. To overcome this issue, add the following entry under *CAB_TASKS_MODULES* in the *SYS.CFG* file and save and load the modified file back into the robot system and then restart the robot system.

```
File "RELEASE:/options/gtpusdk/ScreenMaker.sys" -ModName  
"ScreenMaker"\ -AllTask -Hidden
```

15.4 Frequently asked questions

How to deploy manually to a Virtual Controller

If for any reason you wish to manually by-pass the Deploy button in RobotStudio and the virtual controller, the following information describes what files are to be moved.

Actions

Location of output files

The files that contain the FlexPendant application from ScreenMaker are found (for example) in the **bin** directory under the **My ScreenMaker Projects** located in the **My documents** directory of the user.

For example, **My Documents\My ScreenMaker Projects\SCM_Example\bin** where **SCM_Example** is the example ScreenMaker project.

The files in the **bin** directory are to be copied to a location where the Virtual FlexPendant can read them during the start of the FlexPendant.

Location where the Virtual FlexPendant reads the files

The recommended location for manually copying the ScreenMaker output files is the location of the virtual controller system.

If the system is created manually from **System Builder**, it is located in the **My Documents** directory.

For example, **My Documents\IRB4400_60_SCM_Example\HOME** where **IRB4400_60_SCM_Example** is the example controller system.

If the system is created by a Pack-and-Go and then restored, it is located in the **RobotStudio\System**s folder.

For example,

MyDocuments\RobotStudio\System\IRB4400_60_SCM_Example\HOME where **IRB4400_60_SCM_Example** is the example controller system.

Copy files

Copy the files from the ScreenMaker output to the Home directory of the virtual controller system.

Restart the Virtual FlexPendant and the new application will be loaded.

Picture object and changing images due to I/O

The typical user objective is to have an image that changes when an I/O signal changes, this is common for a digital input to affect the state on the FlexPendant.

Actions

This is accomplished by adding an image and allowing the image to have multiple states.

Set **AllowMultipleState** to **TRUE** and set the Image state.

Create two states and add images for each state:

The **Value** property is extremely important. If binding to a digital input then there are two states for the input, 0 and 1. Set the **Value** property to the value of the

Continues on next page

15 ScreenMaker tab

15.4 Frequently asked questions

Continued

bound variable. 0 and 1 for digital input. It is also possible to bind to RAPID variables and have multiple states and values for the values in the RAPID variable.

Set the SelectedStateValue property to bind to a controller object:

How to get radio buttons to show state when entering

The objective is to have two radio buttons that controls one digital output. When the screen is loaded, the buttons should show the current state of the output.

Actions

Create a group or a panel and place the two radio buttons on the group or panel.

For button1, set the property default value to True and bind the property to the value of the controller digital output signal.

For button2, do not do any changes.

When the screen is loaded, the state of the two radio buttons is established correctly.

What is RAPID array

A RAPID array is a variable that contains more than one value. An index is used to indicate one of the values.

Sample RAPID array

Consider the following RAPID code.

```
VAR string part{3} := ["Shaft", "Pipe", "Cylinder"];
```

Here, 'part' is a RAPID array which consists of three values. The index of the array in part ranges from 1 to 3.

The index of a RAPID array should not be negative and should start with 1.

Screen navigation

Screen navigation in ScreenMaker follows a tree structure.

Consider the following example,

- To open screen **A1**, you first have to open **Screen A**
- To navigate from screen **A1** to screen **B1**, you first have to close screen **A1** and then **Screen A** and navigate from **Main Screen** through **Screen B** to screen **B1**.
- Similarly, to navigate from screen **B1** to screen **C1**, you first have to close screen **B1** and **Screen B** and then navigate from **Main Screen** through **Screen C** to screen **C1**.

Continues on next page

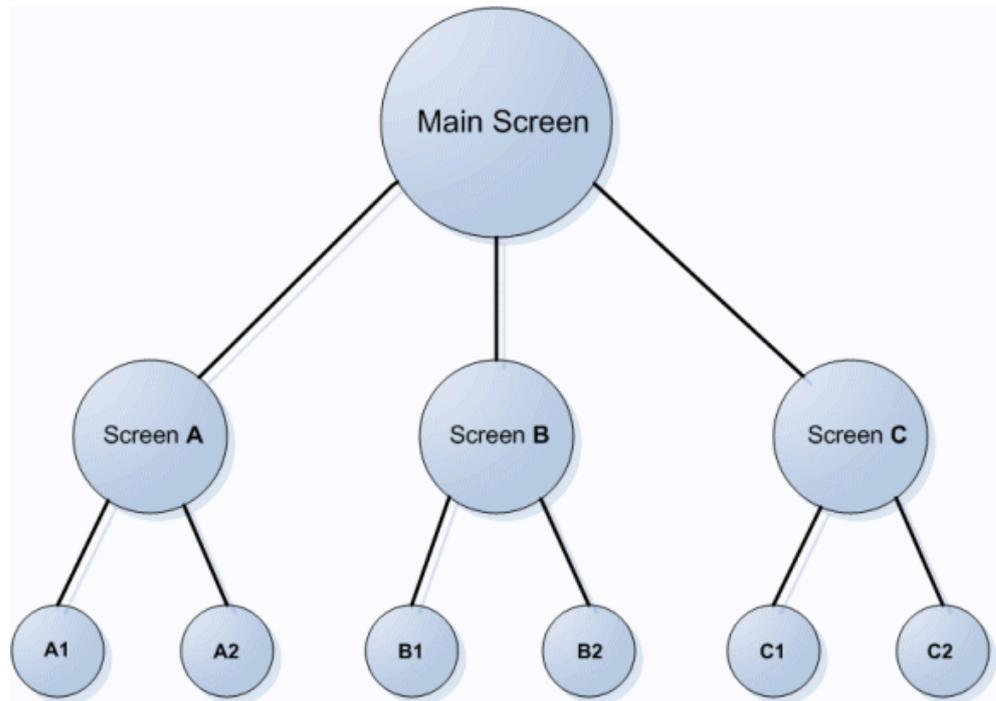

en0900000645

15 ScreenMaker tab

15.5.1 Overview

15.5 Tutorial

15.5.1 Overview

About this chapter

This chapter is designed as a tutorial to take you through the steps involved in designing a FlexArc Operator Panel.

The FlexArc Operator Panel is a simple arc welding cell, where the robots can perform the following three different jobs.

Job	Description
Produce	Welding the part
Service	Service the welding gun
Bull's Eye	Calibrate with bull's eye

The FlexArc Operator Panel displays the following graphic elements:

- Controller Status (controller mode auto or manual and the RAPID execution status)
- Part Status (number of produced parts, the average cycle time per part, and a Reset button)
- Robot jobs (Produce, Service, and Bull's Eye) and Robot locations (Robot at home position, service location, calibration location, and part location)
- Start and Stop buttons

15.5.2 Designing the FlexArc operator panel

Procedure

Use this procedure to design the FlexArc operator panel:

	Action	Information
1	Create a system for the FlexArc operator panel.	<p>Select the following options,</p> <ul style="list-style-type: none"> • FlexPendant Interface • PC Interface <p>For more information about creating a system, see Creating a system from layout on page 228.</p>
2	Load EIO.cfg and MainModule.mod files.	<p>For more information on loading these files, see Loading a configuration file on page 400 and Loading a RAPID module on page 455.</p> <p>By default:</p> <ul style="list-style-type: none"> • For <i>Windows XP</i>, the files can be found at <i>C:\Documents and Settings\<user name="">\My Documents\RobotStudio\My ScreenMaker Projects\Tutorial</user></i> • For <i>Windows 7</i>, the files can be found at <i>C:\Users\<user name="">\Documents\RobotStudio\My ScreenMaker Projects\Tutorial</user></i>

Continues on next page

15 ScreenMaker tab

15.5.2 Designing the FlexArc operator panel

Continued

	Action	Information																																												
3	<p>The following signals are created after loading EIO.cfg file</p> <table border="1" data-bbox="472 376 983 1406"> <thead> <tr> <th data-bbox="472 376 608 443">IO</th> <th data-bbox="608 376 676 443">Type</th> <th data-bbox="676 376 847 443">Description</th> <th data-bbox="847 376 983 443">Conne- ction</th> </tr> </thead> <tbody> <tr> <td data-bbox="472 443 608 573">DI_Ro- botAtHome</td> <td data-bbox="608 443 676 573">DI</td> <td data-bbox="676 443 847 573">Indicates robot at home position</td> <td data-bbox="847 443 983 573">DI_Ro- botAtHome = DO_SIM-HOME</td> </tr> <tr> <td data-bbox="472 573 608 703">DI_RobotAt-Bullseye</td> <td data-bbox="608 573 676 703">DI</td> <td data-bbox="676 573 847 703">Indicates robot at bull's eye position</td> <td data-bbox="847 573 983 703">DI_RobotAt-Bullseye = DO_SIMBU-LLS</td> </tr> <tr> <td data-bbox="472 703 608 833">DI_RobotAt-Service</td> <td data-bbox="608 703 676 833">DI</td> <td data-bbox="676 703 847 833">Indicates robot at service position</td> <td data-bbox="847 703 983 833">DI_RobotAt-Service = DO_SIM-SERVICE</td> </tr> <tr> <td data-bbox="472 833 608 963">DI_PRO-DUCE</td> <td data-bbox="608 833 676 963">DI</td> <td data-bbox="676 833 847 963">Indicates robot is producing part</td> <td data-bbox="847 833 983 963">DI_PRO-DUCE = DO_PRO-DUCE</td> </tr> <tr> <td data-bbox="472 963 608 1021">DO_SIM-HOME</td> <td data-bbox="608 963 676 1021">DO</td> <td data-bbox="676 963 847 1021">Simulate robot at home</td> <td data-bbox="847 963 983 1021"></td> </tr> <tr> <td data-bbox="472 1021 608 1079">DO_SIMBU-LLS</td> <td data-bbox="608 1021 676 1079">DO</td> <td data-bbox="676 1021 847 1079">Simulate robot at bull's eye</td> <td data-bbox="847 1021 983 1079"></td> </tr> <tr> <td data-bbox="472 1079 608 1137">DO_SIM-SERVICE</td> <td data-bbox="608 1079 676 1137">DO</td> <td data-bbox="676 1079 847 1137">Simulate robot at service</td> <td data-bbox="847 1079 983 1137"></td> </tr> <tr> <td data-bbox="472 1137 608 1196">DO_PRO-DUCE</td> <td data-bbox="608 1137 676 1196">DO</td> <td data-bbox="676 1137 847 1196">Simulate robot is producing part</td> <td data-bbox="847 1137 983 1196"></td> </tr> <tr> <td data-bbox="472 1196 608 1254">GI_JOB</td> <td data-bbox="608 1196 676 1254">GI</td> <td data-bbox="676 1196 847 1254">The code of ordered job</td> <td data-bbox="847 1196 983 1254">GI_JOB = GO_JOB</td> </tr> <tr> <td data-bbox="472 1254 608 1312">GO_JOB</td> <td data-bbox="608 1254 676 1312">GO</td> <td data-bbox="676 1254 847 1312">Simulate job order</td> <td data-bbox="847 1254 983 1312"></td> </tr> </tbody> </table>	IO	Type	Description	Conne- ction	DI_Ro- botAtHome	DI	Indicates robot at home position	DI_Ro- botAtHome = DO_SIM-HOME	DI_RobotAt-Bullseye	DI	Indicates robot at bull's eye position	DI_RobotAt-Bullseye = DO_SIMBU-LLS	DI_RobotAt-Service	DI	Indicates robot at service position	DI_RobotAt-Service = DO_SIM-SERVICE	DI_PRO-DUCE	DI	Indicates robot is producing part	DI_PRO-DUCE = DO_PRO-DUCE	DO_SIM-HOME	DO	Simulate robot at home		DO_SIMBU-LLS	DO	Simulate robot at bull's eye		DO_SIM-SERVICE	DO	Simulate robot at service		DO_PRO-DUCE	DO	Simulate robot is producing part		GI_JOB	GI	The code of ordered job	GI_JOB = GO_JOB	GO_JOB	GO	Simulate job order		
IO	Type	Description	Conne- ction																																											
DI_Ro- botAtHome	DI	Indicates robot at home position	DI_Ro- botAtHome = DO_SIM-HOME																																											
DI_RobotAt-Bullseye	DI	Indicates robot at bull's eye position	DI_RobotAt-Bullseye = DO_SIMBU-LLS																																											
DI_RobotAt-Service	DI	Indicates robot at service position	DI_RobotAt-Service = DO_SIM-SERVICE																																											
DI_PRO-DUCE	DI	Indicates robot is producing part	DI_PRO-DUCE = DO_PRO-DUCE																																											
DO_SIM-HOME	DO	Simulate robot at home																																												
DO_SIMBU-LLS	DO	Simulate robot at bull's eye																																												
DO_SIM-SERVICE	DO	Simulate robot at service																																												
DO_PRO-DUCE	DO	Simulate robot is producing part																																												
GI_JOB	GI	The code of ordered job	GI_JOB = GO_JOB																																											
GO_JOB	GO	Simulate job order																																												
4	Create an empty station in RobotStudio with the system created in the previous step.	For more information about creating a station, see New tab on page 211 .																																												
5	Launch ScreenMaker from RobotStudio.	For more information, see Launching ScreenMaker on page 388 .																																												
6	Create a new ScreenMaker project.	<p>For more information, see Creating a new project on page 549.</p> <ol style="list-style-type: none"> 1 Enter the project name as <i>Flex-ArcGUI</i>, and save it in the default location, <i>C:\Users\<user name>\Documents\RobotStudio\My ScreenMaker Projects\Tutorial</i>. 2 A new tab <i>MainScreen</i> is added to the Design Surface. 																																												
7	Configure the Project properties.	To customize how the GUI should appear on the FlexPendant, modify the Project properties. For more information, see Modifying Project properties on page 559 .																																												

Continues on next page

	Action	Information																		
8	Connect to the controller.	For more information, see Connecting to controller on page 560 . The result appears in the output window.																		
9	Create application variables (temporary variables) and configure them with the following data <table border="1" data-bbox="504 539 820 808"> <thead> <tr> <th>Name</th> <th>Type</th> <th>Value</th> </tr> </thead> <tbody> <tr> <td>MyResetValue</td> <td>Num</td> <td>0</td> </tr> <tr> <td>JobProduce</td> <td>Num</td> <td>1</td> </tr> <tr> <td>JobIdle</td> <td>Num</td> <td>0</td> </tr> <tr> <td>JobBulls</td> <td>Num</td> <td>2</td> </tr> <tr> <td>JobService</td> <td>Num</td> <td>3</td> </tr> </tbody> </table> For more information, see Managing application variables on page 568 .	Name	Type	Value	MyResetValue	Num	0	JobProduce	Num	1	JobIdle	Num	0	JobBulls	Num	2	JobService	Num	3	
Name	Type	Value																		
MyResetValue	Num	0																		
JobProduce	Num	1																		
JobIdle	Num	0																		
JobBulls	Num	2																		
JobService	Num	3																		
10	Design the Main Screen.	For more information, see Designing the screen on page 582 .																		
11	Build and Deploy the project.	For more information, see Building and deploying the project on page 588 .																		
12	Open virtual FlexPendant and test the GUI	<ul style="list-style-type: none"> In RobotStudio, press Ctrl+F5 to launch the virtual FlexPendant. Click FlexArc operator panel to launch the GUI. <div data-bbox="1031 1200 1086 1256" style="display: inline-block; vertical-align: middle;"></div> Note Ensure that you switch the controller to Auto mode and start the RAPID execution.																		

15 ScreenMaker tab

15.5.3 Designing the screen

15.5.3 Designing the screen

Introduction to designing the screen

A major effort in the GUI project development is designing screens. The Form designer in the ScreenMaker allows you to drag controls from the toolbox to the design surface. Using the Properties window, you can resize, position, label, color, and configure the controls.

Designing FlexArc Operator Panel screen

Use this procedure to design the FlexArc Operator Panel screen:

- 1 Drag a GroupBox control from the General category; place it on the design surface and set the following values in the Properties window.

Property	Value
Location	14,45
Size	150,100
Title	Controller Status
BackColor	LightGray

- 2 Drag another GroupBox control from the General category; place it on the design surface and set the following values in the Properties window.

Property	Value
Location	14,170
Size	150,204
Title	Part Status
BackColor	LightGray

- 3 Drag a ControllerModeStatus control from the Controller Data category; place it in the *Controller Status* groupbox created and set the following values in the Properties window:

Property	Value
Location	19,40
Size	44,44
BackColor	LightGray

- 4 Drag a RapidExecutionStatus control from the ControllerData category; place it in the *Controller Status* groupbox created and set the following values in the Properties window:

Property	Value
Location	80,40
Size	44,44
BackColor	LightGray

Continues on next page

- 5 Drag a TpsLabel control from the General category; place it in the *Part Status* groupbox created and set the following values in the Properties window:

Property	Value
Location	16,30
Size	131,20
Text	Parts Produced
BackColor	LightGray
Font	TpsFont10

- 6 Drag a NumEditor control from the ControllerData category; place it in the *Parts Status* groupbox created and set the following values in the Properties window:

Property	Value
Location	16,56
Size	116,23
Value	Link to RAPID variable <i>partsReady</i> defined in the module <i>MainModule</i> .

- 7 Drag another TpsLabel control from the General category; place it in the *Part Status* groupbox created and set the following values in the Properties window:

Property	Value
Location	16,89
Size	131,20
Text	Cycle time/part
BackColor	LightGray
Font	TpsFont10

- 8 Drag another NumEditor control from the General category; place it in the *Part Status* groupbox created and set the following values in the Properties window:

Property	Value
Location	16,115
Size	116,23
Value	Link to RAPID variable <i>cycleTime</i> defined in the module <i>MainModule</i> .

- 9 Drag a Button control from the General category; place it in the *Part Status* group box created and set the following values in the Properties window:

Property	Value
Location	33,154
Size	85,34
Text	Reset

Continues on next page

15 ScreenMaker tab

15.5.3 Designing the screen

Continued

Perform the following for the **Reset** button in the *Part Status* group:

Step	Action
1	Double-click the button Reset . The Events Panel dialog box appears which is used to define the actions for Events.
2	<p>In the Events Panel dialog box, click Add Action; point to Rapid Data and select Write a Rapid Data.</p> <p>The Action Parameters dialog box appears; assign Rapid data to the following value and click OK.</p> <ul style="list-style-type: none">• T_ROB1.MainModule.partsReady to MyResetValue.Value <p>Similarly, assign Rapid data to the following value and click OK.</p> <ul style="list-style-type: none">• T_ROB1.MainModule.cycleTime to MyResetValue.Value <p>Two actions of similar type are needed to perform the Reset action. One is to reset Rapid variable partsReady to 0, the other is to reset Rapid variable cycleTime to 0.</p>

- 10 Drag a **PictureBox** control from the **General** category; place it on the design surface and set the following values in the **Properties** window:

Property	Value
Location	177,28
Size	284,359
SizeMode	StretchImage
Image	FlexArcCell.GIF



Note

You can find the graphic (.GIF) files at *C:\MyDocuments\RobotStudio\My ScreenMaker Projects\Tutorial\Images*.

- 11 Drag another **PictureBox** control from the **General** category; place it on the design surface and set the following values in the **Properties** window:

Property	Value
Location	237,31
Size	48,48
SizeMode	StretchImage
Image	RobotAtHome.GIF
AllowMultipleStates	True Select Image property from the StatesEditor dialog box.
SlectedStateValue	DI_RobotAtHome
States	Link State{0} to <i>RobotAtHome_gray.GIF</i> Link State{1} to <i>RobotAtHome.GIF</i>

Continues on next page

**Note**

Add **AllowMultipleStates** option to the PictureBox control. The objective is to have an image that changes when an I/O signal changes.

For more information on how to use **AllowMultipleStates** for PictureBox control, see [Picture object and changing images due to I/O on page 575](#).

- 12 Drag a Button control from the General category; place it on the design surface and set the following values in the Properties window:

Property	Value
Location	486,66
Size	116,105
Text	Start
Font	TpsFont20b
BackColor	LimeGreen
Enabled	Link to DI_RobotAtHome

Perform the following for the **Start** button:

Step	Action
1	Double-click the button Start or click the Smart tag and select <i>Define Actions when clicked</i> . The Events Panel dialog box appears which is used to define the actions for Events.
2	In the Events Panel dialog box, click Add Action ; point to Rapid Data and select Write a Rapid Data . The Action Parameters dialog box appears.
3	In the Action Parameters dialog box, assign Rapid data to the following value and click OK . <ul style="list-style-type: none"> T_ROB1.MainModule.JobProduce to Job.

- 13 Drag a Button control from the General category; place it on the design surface and set the following values in the Properties window:

Property	Value
Location	486,226
Size	116,105
Text	Stop
Font	TpsFont20b
BackColor	LimeGreen
Enabled	Link to DI_PRODUCED

Perform the following for the **Stop** button:

Step	Action
1	Double-click the button Stop or click the Smart tag and select <i>Define Actions when clicked</i> . The Events Panel dialog box appears which is used to define the actions for Events.
2	In the Events Panel dialog box, click Add Action ; point to Rapid Data and select Write a Rapid Data . The Action Parameters dialog box appears.

Continues on next page

15 ScreenMaker tab

15.5.3 Designing the screen

Continued

Step	Action
3	In the Action Parameters dialog box, assign Rapid data to the following value and click OK . <ul style="list-style-type: none"> • T_ROB1.MainModule.JobIdle to JobIdle

- 14 Drag a Button control from the General category; place it on the design surface and set the following values in the Properties window:

Property	Value
Location	274,246
Size	111,47
Text	Bull's Eye
Font	TpsFont14b
Enabled	Link to DI_RobotAtHome
AllowMultipleStates	True Select BackColor property from the StatesEditor dialog box
SelectedStates	DI_RobotAtBull'sEye
States	Link State{0} to <i>Red</i> Link State{1} to <i>Green</i>

Perform the following for the **Bull's Eye** button:

Step	Action
1	Double-click the button Bull's Eye or click the Smart tag and select <i>Define Actions when clicked</i> . The Events Panel dialog box appears which is used to define the actions for Events.
2	In the Events Panel dialog box, click Add Action ; point to Rapid Data and select Write a Rapid Data . The Action Parameters dialog box appears.
3	In the Action Parameters dialog box, assign Rapid data to the following value and click OK . <ul style="list-style-type: none"> • T_ROB1.MainModule.JobBulls to JobBulls

- 15 Drag a Button control from the General category; place it on the design surface and set the following values in the Properties window:

Property	Value
Location	274,324
Size	111,47
Text	Service
Font	TpsFont14b
Enabled	Link to DI_RobotAtHome
AllowMultipleStates	True Select BackColor property from the StatesEditor dialog box
SelectedStates	DI_RobotAtService
States	Link State{0} to <i>Red</i> Link State{1} to <i>Green</i>

Continues on next page

Perform the following for the **Service** button:

Step	Action
1	Double-click the button Service or click the Smart tag and select <i>Define Actions when clicked</i> . The Events Panel dialog box appears which is used to define the actions for Events.
2	In the Events Panel dialog box, click Add Action ; point to Rapid Data and select Write a Rapid Data . The Action Parameters dialog box appears.
3	In the Action Parameters dialog box, assign Rapid data to the following value and click OK . <ul style="list-style-type: none">• T_ROB1.MainModule.JobService to JobService

15 ScreenMaker tab

15.5.4 Building and deploying the project

15.5.4 Building and deploying the project

Procedure

- 1 From the ScreenMaker ribbon, click Build.
For more information on building the project, see [Building a project on page 561](#).
- 2 From the ScreenMaker ribbon, click Deploy.
For more information on deploying the project, see [Deploying to controller on page 561](#).
- 3 In RobotStudio, press **Ctrl+F5** to launch the Virtual Flexpendant and click FlexArc Operator Panel to open the GUI.



Note

Ensure that you start the RAPID execution and switch the controller into Auto mode.

A Technical support

Overview

Contacting ABB

If you have any questions or problems with your RobotStudio installation, please contact your local ABB Robotics Service representative, see <http://www.abb.com/contacts>.

Have the following in mind

- 1 Running the latest version of RobotStudio ensures that it works properly and also includes improvements and new product functionality. ABB recommends that you update to the latest version of RobotStudio whenever a new version is available and before contacting ABB for support.
- 2 Provide a brief description explaining how to reproduce your problem.
- 3 Provide screenshots if applicable. (Use ALT + PRINT SCREEN to get an image of the active window instead of the entire screen.)
- 4 Generate a Full Scan with the **RobotStudio Support Tool** available next to RobotStudio in the Start menu. (Click **Start > Programs > ABB Industrial IT > Robotics IT > RobotStudio > RobotStudio Support Tool**, then click on **Run Full Scan** and then click **Save Report**. Save this report and attach it with your problem description.
- 5 Provide us the following user information:
 - a name
 - b company
 - c contact information
 - d name of the operating system including the language details
 - e subscription ID of the purchased license
 - f Machine ID, see **Help** section of **File** tab

License support

For license-related questions, please contact the team responsible for license support directly at softwarefactory_support@se.abb.com

This page is intentionally left blank

Index

A

ABB library, 226
 action instruction
 about, 32
 Add Controller, 382
 add to path, 485
 Adjust Robtargets, 464
 alerts
 activate, 152
 align frame orientation, 486
 align target orientation, 487
 Application grants, 431
 Application Variables, 568
 create,delete, rename application variables, 568
 attach to object, 488
 Authenticate, 411
 Edit User Accounts, 411
 Login as a Different User, 411
 Log in as Default User, 411
 Log off, 411
 Log off all controllers, 411
 UAS Grant Viewer, 411
 auto configuration, 489
 AutoPath, 248

B

Backup, 392
 create backup, 392
 Back up
 restore backup, 394
 browser
 Layout, 53
 Paths & Targets, 54

C

CAD file
 troubleshoot and optimize, 94
 collision
 detection, 147
 sets, 147
 configuration
 robot axis, 39
 configuration editor, 398
 instance editor, 399
 configuration file, 202
 configuration monitoring
 about, 40
 Configure data binding, 569
 Using Binding menu, 569
 Using Smart tag, 569
 confJ
 about, 40
 ConfL
 about, 40
 Connecting a controller, 560
 Controller grants, 429
 Backup and save, 429
 Calibration, 430
 Delete log, 430
 Edit RAPID code, 429
 Execute program, 429
 Full access, 429
 I/O write access, 429
 Manage UAS settings, 429

 Modify configuration, 429
 Modify controller properties, 430
 Modify current value, 429
 Program debug, 430
 Read access to controller disks, 430
 Safety Controller, 430
 Write access to controller disks, 430
 controller menu, 202
 Controller Shutdown, 440
 controller status window, 61
 access, 62
 controller name, 61
 controller state, 61
 logged on as, 62
 operating mode, 61
 program execution state, 61
 system name, 61
 controller system
 create, 164
 controller world coordinate system, 35
 control panel, 439
 enable device, 439
 manual full speed, 439
 motors on, 439
 operation mode, 439
 release device, 439
 reset emergency stop, 439
 convert frame to workobject, 491
 coordinate systems, 33
 cycle time
 measure, 153

D

data binding
 Controller object data binding, 570
 Data Binding, 569
 Application variable data binding, 571
 data declaration, 30
 deployment package, 183
 detach, 495
 detecting collision, 148
 device browser, 418

E

element
 select, 74
 event
 create, 150
 events, 385
 external axis
 program, 136

F

File transfer, 412
 Controller explorer, 413
 PC explorer, 413
 FlexPendant Viewer, 414
 frame
 converting to workobject, 108
 creating by points, 108
 Frame
 create, 236
 create from three points, 237
 frames, 33
 function, 30

G

- geometry
 - troubleshoot and optimize, 94
- Go Offline, 419
- Grants, about, 163
- Grants, give to groups, 427
- graphics window, 72
- Group, about, 162
- group, add, 426
- group, add user, 425
- group, remove, 427
- group, rename, 426
- Groups, give grants, 427

H

- handle events, 205
 - date and time, 206
 - event category, 206
 - event code, 206
 - event description, 207
 - event log list, 205
 - event title, 206
 - event type, 205
 - manage events, 207
 - retrieve controller events, 207
 - sequential number, 206

I

- I/O
 - set, 151
- I/O system, 386
 - I/O signals, 198
 - input signals, 198
 - output signals, 198
 - simulated signals, 198
 - virtual signals, 198
- import, 92
- import geometry, 234
- import library, 227
- instruction, 30
 - about, 32
- item
 - select, 74

J

- jog
 - mechanism, 109
 - robot, 109
 - several mechanisms, 109
- jog reorient, 269
- jointtarget
 - creating, 110

K

- keyboard shortcuts, 76
 - General commands, 76

L

- Layout browser, 53
- LED, 547
- library
 - troubleshoot and optimize, 94
- Load Parameters, 400
- local coordinate system
 - set, 100
- local origin
 - set, 100

M

- Manage ScreenMaker project
 - Close ScreenMaker, 562
 - ScreenMaker Doctor, 16, 545, 572
- Manage ScreenMaker Project, 549
 - Close project, 561
 - Create project, 549
 - Load project, 550
 - Save project, 550
- Manage Screens, 551
- Managing ScreenMaker Projects
 - Build project, 561
- MediaPool, 29
- Mirror, 514
- Modify project properties, 559
- module, 30
- move instruction
 - about, 32
- Move instruction
 - teach, 258
- MoveJ
 - teach, 258
- MoveL
 - teach, 258
- MultiMove
 - programming workflow, 129

N

- near-miss detection, 149
- network security, 23
- network settings, 159
 - firewall settings, 159
 - local network connection, 159
 - remote network connection, 159
 - service port connection, 159

O

- object
 - select, 74
 - set local origin, 100
 - troubleshoot and optimize, 94
- Offline and Online browser, 55
- Online Monitor, 420
- operator window, 63
 - enabling operator window, 63
 - show virtual operator window, 63
- orientations, 116
 - align target, 118
 - copy and apply, 119
 - target normal to surface, 117
 - unordered, 116
- output window, 60
 - event types, 60

P

- part
 - set local origin, 100
- Password, change for user, 425
- path, 112
 - about, 32
 - compensating, 113
 - creating, 112
 - creating from curve, 112
 - reversing, 112
 - rotating, 113
 - setting axis configuration, 112
 - translating, 113

- Paths & Targets browser, 54
 - Placing an item, 525
 - Frame, 525
 - One Point, 525
 - Three Points, 525
 - Two Frames, 525
 - Two Points, 525
 - positioner.program, 136
 - procedure, 30
 - process time
 - measure, 153
 - program
 - copy, 141
 - programming
 - overview, 107
 - Program Pointer, 468
 - Properties, 416
 - Device Browser, 418
 - Renaming the controller, 416
 - Save System Diagnostics, 418
 - Set controller ID, 416
 - Set date and time, 416
 - View controller and system properties, 417
 - Properties Window
 - Event Help panel, 548
 - Graphical Component Name panel, 548
 - Properties window toolbar, 548
 - Table panel, 548
 - Property editor, 313
- R**
- RAPID**
 - concepts, 30
 - copy program, 141
 - RAPID Data Editor, 457
 - RAPID Editor, 448
 - RAPID instructions, 120
 - RAPID Profiler, 470
 - RAPID task, 460
 - RAPID Watch window, 474
 - reachability
 - test, 127
 - Relation, 402
 - Release Write Access, 410
 - remote subnet, 160
 - repository, 183–184
 - Request Write Access, 409
 - Restore, 394
 - robot
 - programming overview, 107
 - Robot system button, 228
 - adding an existing system, 229
 - adding a template system, 229
 - conveyor setup, 229
 - create system from layout, 228
 - RobotWare, 28
 - license key, 28
 - RobotWare system, 28
 - routine, 30
 - Run mode, 463
 - continuous, 463
 - single, 463
- S**
- safety, 22
 - safety configuration, 407
 - set task frame, 441
- Signal Analyzer, 368
 - signals
 - set, 151
 - simulate
 - alerts, 152
 - create event, 150
 - measure process time, 153
 - set signals, 151
 - TCP trace, 152
 - simulation, 145, 147
 - simulation control, 363
 - Simulation watch, 314
 - Break condition, 315
 - station
 - build workflow, 81
 - pan, 72
 - rotate, 72
 - zoom, 72
 - station world coordiante system, 33
 - Stopwatch, 367
 - switch, 547
 - synchronization, 139
 - station to VC, 139
 - VC to station, 139
 - system
 - create, 164
 - create with positioner, 179
 - RobotWare, 28
 - System Builder, 164, 396
 - about virtual and real systems, 164
 - building new system, 167
 - copying system, 175
 - create boot media, 178
 - create system from backup, 176
 - download a system to controller, 177
 - modify controller system, 171
 - viewing system properties, 166
 - System Configuration, 442
 - controller values, 442
 - stored station values, 443
 - used current station values, 443
 - system parameters, 199
 - editing parameters, 200
 - load parameters, 203
 - save system parameters, 202
- T**
- target, 110
 - about, 32
 - creating, 110
 - modifying, 110
 - modifying with ModPos, 110
 - removing unused, 111
 - renaming, 110
 - teaching, 110
 - Targets on Edge, 245
 - TCP, 33
 - TCP trace
 - activate, 152
 - ToolBox
 - ActionTrigger, 546
 - BarGraph, 546
 - CheckBox, 546
 - ComboBox, 547
 - CommandBar, 547
 - ConditionalTrigger, 547
 - ControllerModeStatus, 547

- DataEditor, 547
- Graph, 547
- GroupBox, 547
- ListBox, 547
- NumEditor, 547
- NumericUpDown, 547
- Panel, 547
- PictureBox, 547
- RapidExecutionStatus, 547
- RunRoutineButton, 547
- TabControl, 547
- Tool Center Point coordinate system, 33
- tooldata, 99
- tools, 99
- TpsLabel, 547
- track
 - program, 136
- Transfer, 402
- trap, 30

U

- UAS Grant Viewer, 428
- UCS, 38
- unpack, 214
- User, about, 162

- User, add, 424
- User, add to group, 425
- User, change password, 425
- User, change user name, 425
- User, enable and disable, 425
- User, remove, 425
- User account, 423
 - User tab, 423
- user coordinate system, 38

V

- VariantButton, 547
- viewpoint, 274
 - create, 274
 - move to viewpoint, 275
 - viewpoint functions, 274
- Virtual FlexPendant, 438
- Virtual FlexPendant operator window, 63

W

- workobject
 - creating, 108
 - modifying, 108
- WorkObject, 38
- workobjects, 108
- world coordinate system, 33

ABB AB, Robotics
Robotics and Motion
S-721 68 VÄSTERÅS, Sweden
Telephone +46 (0) 21 344 400

ABB AS, Robotics
Robotics and Motion
Nordlysvegen 7, N-4340 BRYNE, Norway
Box 265, N-4349 BRYNE, Norway
Telephone: +47 22 87 2000

ABB Engineering (Shanghai) Ltd.
Robotics and Motion
No. 4528 Kangxin Highway
PuDong District
SHANGHAI 201319, China
Telephone: +86 21 6105 6666

ABB Inc.
Robotics and Motion
1250 Brown Road
Auburn Hills, MI 48326
USA
Telephone: +1 248 391 9000

www.abb.com/robotics