

# Irritrol®

*For Professionals Only.™*

## 2013-2014

## PROFESSIONAL IRRIGATION PRODUCTS



**PRO ONLY**

# THE ONLY ALL-PRO CHOICE SINCE 1967



**PRO**ONLY

Only one major irrigation brand is totally dedicated to the professional. That brand is Irritrol. Everything we design and manufacture goes to you. The pros. The ones who make their living installing and selling what we make. Which means we don't sell to big box stores or hardware centers. Since 1967, we've dedicated everything we do to just the pros. You're the ones who built our company. You're the ones who'll keep building our company. **And in our book, loyalty is a very big thing.**

**Irritrol**<sup>®</sup>  
For Professionals Only.™

# TABLE OF CONTENTS

## CONTROLLERS

Controllers "At-A-Glance" .....	2
KwikDial® Series .....	4
Rain Dial® Series .....	6
JR MAX™ Series .....	8
Junior DC™ Series .....	10
Total Control® Series .....	12
PCW Control .....	14
MC-E "Blue" Series .....	18
IBOC® Plus Series .....	20
Sentar II™ .....	22
Rain Master® Eagle™ .....	24
Rain Master® TWICE™ 2-Wire .....	26

## SENSORS & REMOTES

Sensors & Remotes "At-A-Glance" .....	28
RainSensor™ Series .....	30
Climate Logic® Wireless Weather Sensing System .....	32
SR-1 Pump Start Relay .....	35
Flow Sensors .....	36
CRR (Contractor Residential Remote) .....	38
Pro Max™ Remote (Universal Maintenance Remote) .....	40

## VALVES

Valves "At-A-Glance" .....	42
2400/2600 Series "Jar-Top" .....	44
205 Series .....	46
2500 Series .....	48
2700 Series Anti-Siphon (Electric & Manual) .....	50
311A Series Anti-Siphon .....	52
2623DPR Series/300 Series (Valve Adapters) .....	54
200B Series .....	56
700 Series (UltraFlow®) .....	58
100 Series (Century PLUS) .....	60
100-S Series (Century PLUS Scrubber) .....	62
Drip Zone Valve Kits .....	64
OmniReg® (Modular Pressure Regulator) .....	66
Accessories .....	67

## ROTORS

Rotors "At-A-Glance" .....	68
430R Series 1/2" Rotor .....	70
TITAN™ 1/2" & 3/4" Rotor .....	71
550R Series 3/4" Rotor .....	72
Platinum Sport Series 1" Rotor .....	74

## SPRAY HEADS & NOZZLES







Spray Heads "At-A-Glance" .....	76
I-PRO™ Series .....	78
I-PRO™ MPR/Specialty Nozzles Series .....	80
Pro-VAN Nozzles Series .....	82
533 Bubbler .....	84
Accessories .....	85
Super Blue Flex™/Flex Assemblies .....	86

## RESOURCES

Communications Directory .....	89
Formulas/Sprinkler Spacing and Precipitation Rate Formulas .....	90
Conversion Factors/Friction Loss Formulas .....	91
Friction Loss Characteristics .....	92
Water Meter Pressure Loss Chart .....	109
Slope Irrigation Chart .....	110
Wire Sizing .....	111
Irritrol Mobile App .....	112
Trade Warranty .....	113

# CONTROLLERS

The contractor's choice for more than 30 years, Irritrol® controllers are user-friendly and easy to program. Names such as Rain Dial®, Total Control®, MC-E and Rain Master™ are synonymous with dependability and quality. And with our revolutionary PCW Control product, we continue to redefine ease of use in irrigation control.

AT-A-GLANCE						
	KWIKDIAL®	RAINDIAL®-R	JR MAX™	JUNIOR™ DC	TOTAL CONTROL®-R	PCW CONTROL
	pgs 4-5	pgs 6-7	pgs 8-9	pgs 10-11	pgs 12-13	pgs 14-17
STATIONS	4, 6, 9, 12	6, 9, 12	6, 8	4, 6, 8	6, 9, 12, 15, 18 & 24	12, 24, 36, 48
PROGRAMS	3 Independent	3 Independent	3 Independent	3 Independent	4 Independent	N/A
START TIMES	9	9	7	7	16	120
INDOOR LOCATION	●	●	●	●	●	●
OUTDOOR LOCATION	●	●	●	●	●	●
WATER BUDGETING	●	●	●	●	●	●
ELECTRONIC CIRCUIT BREAKER	●	●	●	●	●	●
AUTOMATIC, ET-BASED	Climate Logic® Option	Climate Logic® Option			Climate Logic® Option	
REMOTE READY	●	●			●	●
COMPUTER-BASED (PC) PROGRAMMING						●
UPDATES WITH ONLINE WEATHER						●
CLIMATE LOGIC® COMPATIBLE	●	●			●	
WARRANTY	3 years	5 years	2 years	2 years	5 years	5 years (90 days, software)

# AT-A-GLANCE



	MC-E "Blue"	IBOC® PLUS	SENTAR II™	RAIN MASTER® EAGLE™	RAIN MASTER® TWICE™ 2-WIRE
	pgs 18-19	pgs 20-21	pgs 22-23	pgs 24-25	pgs 26-27
<b>ET-BASED WATER SAVINGS</b>	Climate Logic® Option			●	●
<b>CENTRAL CONTROL</b>				●	●
<b>WEATHER STATION INTERFACE</b>	●			●	●
<b>MAXIMUM STATIONS</b>	48	12	36	36	36
<b>NUMBER OF PROGRAMS</b>	8	3	4	4	4
<b>NUMBER OF START TIMES</b>	48	24	5	5	5
<b>MAXIMUM STATION RUNTIME</b>	10 hrs	23 hrs. 59 mm	9:59 hh:mm	9:59 hh:mm	9:59 hh:mm
<b>INTER-STATION DELAY TIME</b>	●		1-255 Sec	1-255 Sec	1-255 Sec
<b>ODD/EVEN DAY WATERING</b>	●	●		●	Rain Master Eagle
<b>WATER BUDGET (%)</b>	0-255%	●	0-300%	0-300%	0-300%
<b>CYCLE AND SOAK PROGRAMMING</b>			●	●	●
<b>SKIP DAY PROGRAMMING OPTION</b>	●	●	●	●	●
<b>PROGRAMMABLE RAIN DELAY</b>	1-14 Days	●	1-7 Days	1-7 Days	1-7 Days
<b>RAIN/FREEZE SENSOR INPUT</b>	●	●	1	1	1
<b>AUDIBLE MALFUNCTION ALARM</b>	●		●	●	●
<b>STATION HIGH FLOW MONITORING/ALERT</b>	●		●	●	●
<b>MAIN LINE FLOW MONITORING/ALERT</b>	●		●	●	●
<b>STATION NO FLOW ALERT</b>				●	Rain Master Eagle
<b>RAIN SENSOR BY PROGRAM</b>		●	●	●	●
<b>BATTERY REQUIREMENTS</b>	None	Battery Powered	None	None	None
<b>BUILT-IN REMOTE INTERFACE</b>	●		●	●	●
<b>TWICE-2 WIRE COMPATIBLE</b>					Rain Master Eagle
<b>SOLAR POWER OPTION</b>		●			
<b>WARRANTY</b>	5 years	5 years	5 years	5 years	2 years

# KWIKDIAL® SERIES



## 4, 6, 9 AND 12 STATION OUTDOOR/INDOOR

KwikDial®, the ideal residential controller from Irritrol®, offers a unique combination of sophisticated features and simple operation. Excellent scheduling flexibility is provided by its automatic, semi-automatic and manual operations, a wide range of watering intervals, and the ability to make percentage changes to watering duration for seasonal adjustments. Peace of mind is ensured by the controller's electrical surge protection, a self-diagnostic, electronic circuit breaker and built-in memory that maintains time, date and programming information for 24 hours in the absence of AC power. Now, when automatically adjusted by Irritrol's new, optional CLIMATE LOGIC® Weather Sensing System, the KwikDial becomes a smart, climate-based controller. (See CLIMATE LOGIC page)

## KEY FEATURES & BENEFITS

### CLIMATE LOGIC® COMPATIBLE

Automatically adjusts KwikDial watering based on the weather

### THREE INDEPENDENT PROGRAMS

Allows differing watering days, start times, station run times and station assignments

### MULTIPLE WATERING DAY OPTIONS

Provides flexibility to meet water restrictions and diverse plant requirements:

- Days-of-the-week watering
- Odd/even date watering with 31st day skip
- Repeating-day-interval watering (every day, every 2nd day, every 3rd day, etc., up to once every 31 days)
- Excluded-day option, when used with the odd/even day or day-interval

### COMPATIBLE WITH CRR SERIES HAND-HELD REMOTE SYSTEM

Provides convenient remote station start/pause/resume/off capability (R-100-KIT) for supplemental watering or inspection

### SELF-DIAGNOSTIC, ELECTRONIC CIRCUIT BREAKER

Identifies and overrides an electrical "short" in a valve or in valve wiring and continues to water operable stations

### FULL FAMILY OF INDOOR AND OUTDOOR MODELS

Ensures a product to match any landscape

### SENSOR HOOKUP WITH BYPASS SWITCH COMPATIBLE WITH IRRITROL'S RAISENSOR™ SERIES

Saves water by shutting off the system during rain

### PROGRAM STACKING FEATURE

Prevents program overlap

### ELECTRICAL SURGE PROTECTION (ON BOTH INPUT AND OUTPUT LINES)

Resists damage from lightning storms and power surges

## FLEXIBLE WATER DAY AND START TIME OPTIONS



- 1 Any-day-of-the-week watering
- 2 Odd/Even day watering
- 3 Day interval watering from 1-31 days
- 4 Up to 3-starts per day per program

## CLIMATE LOGIC® COMPATIBLE



## SPECIFYING INFORMATION

MODEL	NUMBER OF STATIONS	CONFIGURATION
<b>KD</b> - KWIKDIAL	4 - 4 Station 6 - 6 Station 9 - 9 Station 12 - 12 Station	<b>EXT</b> - Outdoor <b>INT</b> - Indoor

Example: A KwikDial 9 station, outdoor model = **KD9-EXT**

## ADDED FEATURES

- Automatic, semi-automatic (manual program) and manual station(s) operation
- Programmable "Rain Off" up to seven days
- One dial and four push buttons for ease of programming
- Large LCD displays status of programs scheduled to run each day
- Multiple language capabilities (English, French, German, Italian and Spanish)
- Built-in memory maintains real time and programming information for a minimum of 24 hours in the absence of AC power (no battery required)
- "All stations" test program
- Water budgeting feature for each program (0-200% in 10% increments)
- Weather-resistant plastic case with internal transformer (outdoor model) and provision on door for a padlock
- Durable plastic case with plug-in transformer (indoor model)
- Three-year warranty

## OPERATING SPECIFICATIONS

- Station run times: 1-240 minutes (4 hours) in 1-minute increments
- Start times: 3 per program for up to 9 daily starts

## ELECTRICAL SPECIFICATIONS

- Transformer input: 120 V ac, 60HZ (220/240 V ac, 50 Hz)
- Transformer output: 24 V ac, .830 amps
- Maximum output per station: 24 V ac, .4 amp
- Maximum total output: 24 V ac, .8 amp (including master valve)
- Capacity: One station valve plus a master valve (or 24 V ac pump start relay) on at a time
- UL and CUL listed

## MODELS

Model	Description
KD4-EXT	4 -Station Outdoor
KD6-EXT	6 -Station Outdoor
KD9-EXT	9 -Station Outdoor
KD12-EXT	12 -Station Outdoor
KD4-INT	4 -Station Indoor
KD6-INT	6 -Station Indoor
KD9-INT	9 -Station Indoor
KD12-INT	12 -Station Indoor

## DIMENSIONS

- Outdoor: H: 9", W: 6 7/8", D: 4"
- Indoor: H: 8 7/8", W: 6 1/8", D: 3"

## OPTIONAL ACCESSORIES

- RS1000 wireless RainSensor™
- RFS1000 wireless rain/freeze sensor
- RS500 wired RainSensor™
- CRR remote series (R-100-KIT)
- SR-1 pump start relay
- CL-100-Wireless Weather Sensing System

# RAIN DIAL-R<sup>®</sup> SERIES



## 6, 9, AND 12 STATION OUTDOOR/INDOOR

In addition to the numerous upgrades built into this popular, long-standing controller, the optional CLIMATE LOGIC<sup>®</sup> Wireless Weather Sensing System makes the Rain Dial-R a "smart" controller on the cutting edge of water management. When governed by Climate Logic, the Rain Dial-R will automatically water more on warm or hot days and less on cooler days. Applying the right amount of water to maintain a healthy landscape, the Rain Dial-R and weather-based Climate Logic Weather System seriously reduce overwatering and its expense.

## KEY FEATURES & BENEFITS

### CLIMATE LOGIC READY

Automatically reschedules Rain Dial-R watering based on the weather

### REMOTE CONTROL READY

Compatible with CRR (Contractor Residential Remote) remote series

### RAINSENSOR<sup>™</sup> READY

Sensor bypass switch and terminal for sensor hookup

### THREE INDEPENDENT PROGRAMS

Programming flexibility to meet the needs of a wide variety of plant material on the landscape site

### THREE WATER DAY CHOICES

- Any day of the week, skip days or odd/even dates
- Skip days and odd/even dates have day exclusion option

### WATER BUDGETING

For quick changes to the watering durations of all stations on a program at one time or pre-set a change in water budget for each month.

### 365-DAY CALENDAR FOR ODD/EVEN DATE WATERING

Meets the odd/even date watering mandates often used for landscape water reductions

### WATER WELL RECOVERY (DELAY BETWEEN STATIONS)

Option of pump circuit ON or OFF during delay

### MASTER VALVE/PUMP START CIRCUIT ASSIGNABLE PER STATION

Stations requiring a booster pump can be supplied while other stations can run on street water pressure

### TEST ALL STATIONS PROGRAM

Allows a quick test of all stations from lowest to highest number

### CLEAR/ERASE MEMORY BY PROGRAM

Saves time by quickly erasing only the program desired

### PROGRAM STACK OR OVERLAP OPTION

Allows three programs/stations on at once or restricts operations to no overlapping station runs

### SNAP-OUT FACE PANELS

6, 9 and 12-station models all have 12-station terminal boards allowing interchangeable front panels to change station number

### MANUAL STATION ADVANCE

During automatic, semi-automatic and station test cycles, allows quick advancement of operation up through the stations



## CLIMATE LOGIC® COMPATIBLE



## REMOTE CONTROL COMPATIBLE



Irritrol's Contractor Residential Remote (CRR) plugs into the Rain Dial-R face panel and connects to 24-Volt AC terminals.

For 1-person maintenance and trouble shooting, the CRR can operate individual stations on the Rain Dial-R from a range up to 1½ miles.

## SPECIFYING INFORMATION

MODEL	NUMBER OF STATIONS	CONFIGURATION	
RD - RAIN DIAL	600 - 6 Station 900 - 9 Station 1200 - 12 Station	EXT - Outdoor INT - Indoor MOD - Module	R - Rain sensor ready

Example: A Rain Dial 6 station, outdoor model = **RD600-EXT-R**

## ADDED FEATURES

- Automatic, semi-automatic and manual operation
- Weather-resistant plastic, key-lock cabinet with an internal transformer (outdoor models)
- Durable plastic cabinet with an external transformer (indoor models)
- Electrical surge protection (on both input and output lines) resists damage from lightning storms and power surges
- Self-diagnostic circuit breaker
- Wall-mountable
- Five-year warranty

## OPERATING SPECIFICATIONS

- Station run times: 1-59 minutes in 1-minute increments or 1-5.9 hours in .1-hour (6 minute) increments
- Start times: 3 per program per day for 9 starts total
- Watering schedules per program:
  - Any day of the week
  - Skip days from 1 to 31 days between irrigation days
  - Odd or even date watering

## ELECTRICAL SPECIFICATIONS

- Transformer input: 120V ac, 60Hz (220/240V ac, 50Hz available internationally)
- Transformer output: 24V ac, 1.25 amps
- Maximum output per station: 24V ac, .5 amps
- Maximum output to valves: 24V ac, 1.0 amps (including master valve/pump start circuit)
- Battery backup for "armchair" programming and keeping current time and date: 9-volt alkaline (not included)
- UL and CSA listed

## MODELS

Model	Description
RD600-EXT-R	6 -Station, Outdoor
RD900-EXT-R	9 -Station, Outdoor
RD1200-EXT-R	12 -Station, Outdoor
RD600-INT-R	6 -Station, Indoor
RD900-INT-R	9 -Station, Indoor
RD1200-INT-R	12 -Station, Indoor
RD6-MOD-R	Module assembly, 6 -Station
RD9-MOD-R	Module assembly, 9 -Station
RD12-MOD-R	Module assembly, 12 -Station

## DIMENSIONS

- **Outdoor:** H: 7 ¾", W: 10 ¾", D: 4"
- **Indoor:** H: 7 ¾", W: 7", D: 3 ¾"

## OPTIONAL ACCESSORIES

- RS1000 wireless RainSensor™
- RFS1000 wireless rain/freeze sensor
- RS500 wired RainSensor™
- SR-1 pump start relay
- CRR remote series (R-100-KIT)
- R102-5476 (16x20 pin adapter) cable
- CL-100-Wireless Weather Sensing System

# JR MAX™ SERIES



## 6 AND 8 STATION, OUTDOOR/INDOOR

The Irritrol® Junior Max (JR Max™) controllers combine simplicity and affordability with a host of modern irrigation control features ideal for residential landscape applications. Built for today's water use challenges, the JR Max offers a 365-day calendar for optional odd or even date watering as well as any-day-of-the-week and repeating day interval water day capabilities. This irrigation flexibility is further enhanced by three programs, up to seven start times per day and station timing from 1 minute up to 4 hours. Program "C" even has a "looping cycle" for "grow in" periods for sod, seed or misting applications.

## KEY FEATURES & BENEFITS

### THREE INDEPENDENT PROGRAMS WITH START-TIME STACKING

Provide the convenience of three controllers in one

### PROGRAM "C" CAN BE SET TO A LOOPING FUNCTION

Provides continuous moisture for "grow in" (Loop can also be set in seconds)

### SELF-GUIDED PROGRAMMING

Simplifies programming by prompting the user through irrigation scheduling

### MULTIPLE WATERING DAY OPTIONS

Provides flexibility to meet water restriction requirements:

- 365-day calendar for true odd/even watering
- Odd/even date watering with 31st day skip
- 7-day calendar or up to 14 day intervals

### PROGRAM REVIEW FEATURE

Ensures quick programming check and operation review

### RUGGED, LOCKABLE, WEATHER-RESISTANT CABINET ON OUTDOOR MODELS

For installation flexibility

## AVAILABLE IN INDOOR AND LOCKING OUTDOOR MODELS



6-station, Indoor model (JRMAX-6-120) with flip-up cover



8-station, outdoor model (JRMAX-8-120-EXT) with locking door

### SPECIFYING INFORMATION

JRMAX - X - 120 - XXX

MODEL	NUMBER OF STATIONS	CONFIGURATION
JRMAX - JR MAX	6 - 6 Station 8 - 8 Station	EXT - Outdoor

Example: A JR MAX controller, 8 station, 120V input, outdoor model = **JRMAX-8-120-EXT**

### ADDED FEATURES

- Automatic, semi-automatic (to manually start preset programs) and multi-manual start operation
- Sensor port standard
- Built-in rain delay option
- "Armchair" programming allows programming without AC power
- Programmable master valve per program
- Electronic fuse protection
- Real-time battery backup maintains accurate time in the absence of AC power—a 9-volt battery (not included) must be installed for proper operation even under AC power.
- On-board coin cell battery maintains program up to five years
- Automatic safety backup program
- Multiple language capabilities (English, French and Spanish)
- Flip cover protects large LCD display (indoor models)
- Two-year warranty

### OPERATING SPECIFICATIONS

- Station run times: 1 minute to 4 hours in 1-minute increments
- Start times: 3 starts for programs A and B, one start for program C in regular mode, unlimited starts in looping mode
- Watering schedule: calendar, interval, odd/even
- Water budgeting: 0-200% in 10% transformer output

### ELECTRICAL SPECIFICATIONS

- Transformer input: 120 V a c, 60 Hz – plug-in transformer; usETLc listed
- Transformer output: 24 V ac, 500 mA
- Maximum output per station: 24 V ac, .25 amp
- Maximum total output: 24 V ac, .5 amp
- Capacity: one station valve plus a master valve

### MODELS

Model	Description
JRMAX-6-120-EXT	6 -Station, outdoor mount
JRMAX-8-120-EXT	8 -Station, outdoor mount
JRMAX-6-120	6 -Station, indoor mount
JRMAX-8-120	8 -Station, indoor mount

### DIMENSIONS

- **Outdoor:** H: 7 7/8", W: 6 3/4", D: 3 5/8"
- **Indoor:** H: 4 7/16", W: 5 7/16", D: 1 5/8"

### OPTIONAL ACCESSORIES

- RS1000 wireless RainSensor™
- RFS1000 wireless rain/freeze sensor
- RS500 wired RainSensor™

# JUNIOR DC™ SERIES



## 1 AND 4 STATION, OUTDOOR/INDOOR

When AC power is a problem, the JUNIOR DC battery-operated controllers are the solution! Whether for temporary operations like irrigation system wire repairs or permanent applications where AC power to the valves is expensive or impractical, the JUNIOR DC controllers can handle the job. And because valve boxes occasionally flood, these valve-mounted controllers are waterproof! For water savings, JUNIOR DC controllers are compatible with wired rain sensors.

## KEY FEATURES & BENEFITS

### **BATTERY-OPERATED**

Provides automatic irrigation in areas without A.C. power

### **WATERPROOF (IP68)**

To survive the occasional flooded valve box

### **VALVE MOUNT OR WALL MOUNT OPTION**

Mount right on the D.C. solenoid or wall mount up to 900' away

### **1- AND 4-STATION MODELS**

For temporary power to one valve or permanent power to a system without A.C.

### **COMPATIBLE WITH WIRED RAINSENSOR™**

Saves water by preventing irrigation during a downpour

### **USE IRRITROL DCL, DC LATCHING SOLENOID**

**JUNIOR DC™ WALL INSTALLATION**

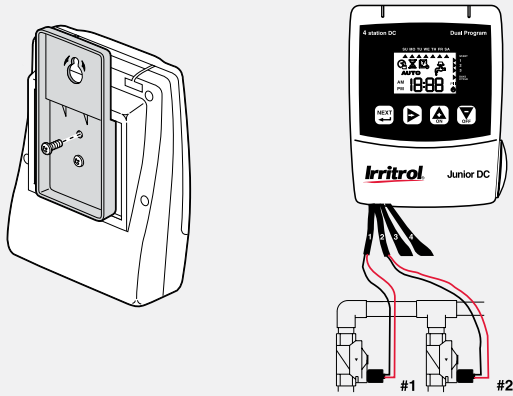

**JUNIOR DC VALVE MOUNTED**

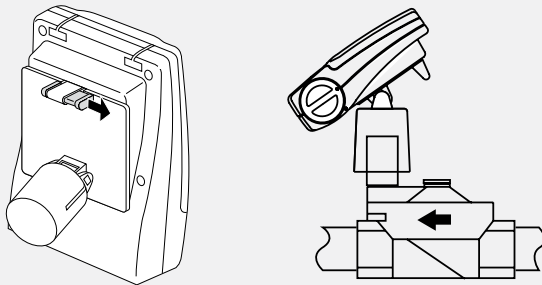

**SPECIFYING INFORMATION**

MODEL	CONNECTION
JRDC - Junior DC	1 - 1 station 4 - 4 station

Example: A 4 station Junior DC controller = **JRDC-4**

**ADDED FEATURES**

- Battery operated
- Waterproof tested (IP68)
- Compatible with wired RainSensor™
- 1-station and 4-station models
- Valve-mounted on the solenoid or wall-mounted
- Two independent programs
- Program stacking (prevents overlapping operations)
- Program erase and total erase functions
- "Off" setting for rainy weather
- Low battery indicator
- 2-year warranty

**OPERATING SPECIFICATIONS**

- 3 start times per program
- Watering Time: 1-155 minutes (in 1-minute increments)
- Water Budgeting (10% to 200%)
- 7-day "select day" watering schedule or day intervals from 1-14 days

**ELECTRICAL SPECIFICATIONS**

- Uses one, 9-volt, Alkaline battery
- Output to solenoid is a DC pulse
- Use with Irritrol "DCL", DC, latching solenoids and Irritrol valves
- cULus listed
- Maximum wire length to DCL: 660' to 960' depending on wire gauge (see below)

Wire Size	Maximum Wire Length
#18	660 feet
#16	800 feet
#14	960 feet

**MODELS**

Model	Description
JRDC-1	1-station
JRDC-4	4-station

**DIMENSIONS**

- **1 station:** H: 1 1/2", W: 1 3/4", D: 3 3/4"
- **4 stations:** H: 1 1/2", W: 1", D: 3"

**OPTIONAL ACCESSORIES**

- RS500 wired RainSensor™

# TOTAL CONTROL®-R SERIES



EPA WaterSense®  
Certified when used with  
Irritrol® Climate Logic®

## 6, 9, 12, 15, 18, 24, 36 & 48-STATION\* OUTDOOR/INDOOR

The Irritrol® Total Control-R family of models is proof that advanced design controllers don't have to be complicated. Developed to meet a wide variety of watering requirements, the easy-to-program Total Control Series is available in models ranging from 6 to 48 stations. Programming flexibility is provided by four independent programs, 16 total start times and a 365-day calendar for odd/even day scheduling. And now, the Total Control-R has a weather-based option with Irritrol's new CLIMATE LOGIC®!

## KEY FEATURES & BENEFITS

### CLIMATE LOGIC® COMPATIBLE

Turn the Total Control into a weather-based controller using an on-site wireless weather sensor.

### NEW "R" MODELS ARE REMOTE-READY

For Irritrol's Contractor Residential Remote (CRR) series

### FOUR INDEPENDENT PROGRAMS OFFER CONCURRENT OPERATION CAPABILITY

For scheduling flexibility

### SEVEN-DAY CALENDAR, ODD/EVEN DAY OR DAY-INTERVAL OPTIONS FROM ONE TO 30 DAYS

Provides the flexibility to meet water restrictions or plant watering requirements

### PROGRAMMABLE MASTER VALVE ON/OFF PER PROGRAM

Provides the flexibility of running some programs with a booster pump and some without

### NON-VOLATILE MEMORY

Holds program during power failures for reliable operation

### FLEXIBLE STATION RUN AND START TIMES

Meet a broad range of watering requirements

### 6-, 9- AND 12-STATION MODELS HAVE 12-STATION TERMINAL BOARDS; 15-, 18- AND 24-STATION MODELS HAVE 24-STATION TERMINAL BOARDS

Allows for station count increase simply by changing face panel module

### SENSOR HOOKUP WITH BYPASS SWITCH COMPATIBLE WITH THE IRRITROL RAINSENSOR™ SERIES

Saves water by shutting off the system during rainfall

### NEW 36 AND 48-STATION MODELS

For irrigating larger landscapes

\*15-, 18-, 24-, 36- and 48-station controllers are available in outdoor models only

### ADDED FEATURES

- User-friendly, 10-position programming dial and large, easy-to-read display
- Excluded-day option, when used with the odd/even date option, allows selection of specific day(s) not to water
- 365-day calendar for odd/even day programming
- Start time stacking within each program
- Programmable "Rain Off" up to seven days
- Automatic, semi-automatic, manual and timed-manual operation
- Self-diagnostic circuit breaker
- Electrical surge protection (on both input and output lines)
- Durable plastic cabinet with an external transformer (indoor models)
- Wall-mountable
- Five-year warranty

### CLIMATE LOGIC® READY!

Make Total Control-R a weather-based controller with automatic water budget adjustments, every day, with the Climate Logic Wireless Weather Sensing System.



Easy connection to the back of timing module allows quick plug-in of the CLIMATE LOGIC® receiver module.

### 36-and 48-STATION MODELS AVAILABLE!



- Commercial-grade, lockable, metal cabinet
- Full size terminal strips
- Electrical surge protection.

### SPECIFYING INFORMATION

MODEL	STATIONS	CONFIGURATION	
TC - TOTAL CONTROL	6 - 6 Station 9 - 9 Station 12 - 12 Station 15 - 15 Station 18 - 18 Station 24 - 24 Station 36 - 36 Station 48 - 48 Station	EX - Outdoor IN - Indoor MOD - Module	R - Remote control ready

Example: A Total Control 12 station, outdoor model = **TC-12EX-R**

### OPERATING SPECIFICATIONS

- Station run times: 1 minute to 10 hours in 1-minute increments
- Start times: 16 total starts assignable to any program
- Water budgeting: 10-200% in 10% increments

### ELECTRICAL SPECIFICATIONS

- Electronic circuit breaker: 1.25 amps minimum holding
- Maximum output per station: 24 V ac, .5 amp
- Maximum output to valves: 24 V ac, 1.25 amps (including master valve)
- Battery backup: 9-volt alkaline battery (not included)
- UL and CSA listed (6-, 9-, 12-, 15-, and 18-station models)
- UL and CUL listed (24, 36, & 48-station models)
- **Outdoor**
  - Transformer input: 120 V ac, 60 Hz (220/240 V ac, 50 Hz)
  - Transformer output: 24 V ac, 1.67 amps
- **Indoor**
  - Transformer input: 120 V ac, 60 Hz (220/240 V ac, 50 Hz)
  - Transformer output: 24 V ac, 1.25 amps

### MODELS

Model	Description
TC-6EX-R	6 -Station Outdoor
TC-9EX-R	9 -Station Outdoor
TC-12EX-R	12 -Station Outdoor
TC-15EX-R	15 -Station Outdoor
TC-18EX-R	18 -Station Outdoor
TC-24EX-R	24 -Station Outdoor
TC-36EX-R	36 -Station Outdoor (metal cabinet)
TC-48EX-R	48 -Station Outdoor (metal cabinet)
TC-6IN-R	6 -Station Indoor
TC-9IN-R	9 -Station Indoor
TC-12IN-R	12 -Station Indoor
TC-6MOD-R	Module assembly, 6 -Station
TC-9MOD-R	Module assembly, 9 -Station
TC-12MOD-R	Module assembly, 12 -Station
TC-15MOD-R	Module assembly, 15 -Station
TC-18MOD-R	Module assembly, 18 -Station
TC-24MOD-R	Module assembly, 24 -Station

### DIMENSIONS

- **Outdoor:** H: 8 1/2", W: 10 1/2", D: 5"
- **Indoor:** H: 7 1/2", W: 9 1/2", D: 4 1/4"
- **Metal:** (36 & 48-station) H: 15 3/4", W: 10 3/4", D: 5 3/4"

### OPTIONAL ACCESSORIES

- RS1000 wireless RainSensor™
- RFS1000 wireless rain/freeze sensor
- RS500 wired RainSensor™
- SR-1 pump start relay
- CRR remote series (R-100-KIT)
- CL-100-Wireless Weather Sensing System

# PCW CONTROL SERIES

COMPUTER-CONTROLLED



## 12 STATION OUTDOOR/INDOOR (expandable to 48-station)

The first of its kind, Irritrol's computer-controlled residential controller increases the professional installer's sales, installation and service productivity while providing the highest level of end-user convenience.

## KEY FEATURES & BENEFITS

### PC-COMPATIBLE SCHEDULING SOFTWARE

User-friendly software that is precise, flexible, and intuitive with its computer interface

### 2-WAY HANDHELD REMOTE WITH DESKTOP STAND

Provides the convenience of wirelessly programming the controller in the garage from the desk in the user's home office or den.

### SCHEDULING ADVISOR™

Saves water automatically by adjusting the irrigation schedule when set to receive the online weather data

### INTERNET COMPATIBILITY

Allows the owner to send schedules over the Internet. The installer or Irritrol Tech Support can alter the program and return it to the client

### 12-STATION CONTROLLER WITH 2-WAY RADIO MODULE

Acknowledges the receipt of a new program, stores it in memory and automatically runs it according to schedule. Controller installation and field wire hookup are the same as a conventional controller

### SELECTABLE PERSONAL ID NUMBER (PIN)

Unique, selectable number for each system's security prevents overlapping instructions from another PCW Control system and reduces the chance of unauthorized program entry

### SYSTEM EXPANDABILITY UP TO 48 STATIONS

To meet the need for larger systems, 12-station indoor or outdoor "add-on" controllers within range of the 2-way radio modules can be added. The system sees station #1 on the second controller as zone #13

### LANDSCAPE LIGHTING CONTROL

Allows up to 3 zones to be designated to run relays for control of landscape lighting. (Controller does not supply main power to the lighting.) SR-1 Pump Start Relay is recommended

### CONTRACTOR SETTINGS DEFAULT

With a click of the mouse, the owner can reactivate the installer's original program



## AVAILABLE IN BOTH INDOOR AND OUTDOOR MODELS



Indoor model



Outdoor model

## EASY SYSTEM EXPANSION UP TO 48 STATIONS



Up to four controllers can be spaced throughout the property

## CONTROL LANDSCAPE LIGHTING, TOO!

### WIRING DIAGRAM FOR LANDSCAPE LIGHTING ZONE

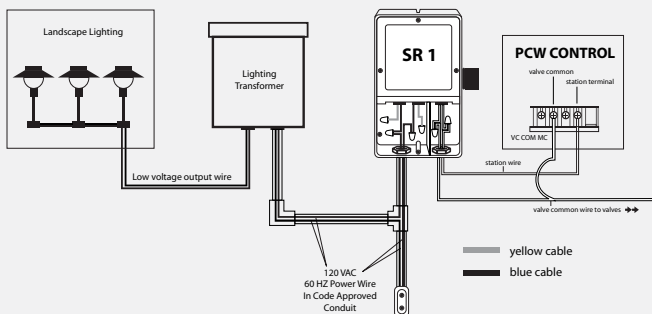

## OPERATING SPECIFICATIONS

- Station run time: up to 24 hours (in hour and minute increments)
- Programs: 10 per zone (120 total)
- Watering day schedules selectable per zone: Any days-of-the-week watering, interval watering (selectable in 1-day increments) from daily to once every 30 days and Odd or Even date watering
- Day exclusion option for setting "non-water" days
- Hour exclusion option for daily non-watering hours
- Optional RainSensor™ for multi-controller systems: Connect sensor to controller #1
- RainSensor™ assignable per station
- Optional pump start relay for multiple controller systems: connect relay to controller #1 (for pump control)
- PIN number range: selectable from 0001 to 9999
- Range of two-way remote: 1,000' line-of-sight, less when obstructed or experiencing interference
- Customized semi-automatic programs
- For contractors: stores multiple customer's schedules

## ELECTRICAL SPECIFICATIONS

- Transformer input: 120 V ac, 60HZ
- Transformer output: 24 V ac (30VA)
- Maximum output per station: 24 V ac, .4 amp
- Maximum total output: 24 V ac, 1 amp (including master valve)

## MODELS

Model	Description
PCW-12-INT-PAK	12-Stn. indoor controller, remote, disk
PCW-12-ADD-INT	12-Stn. add-on controller (indoor)
PCW-12-EXT-PAK	12-Stn. outdoor controller, remote, disk
PCW-12-ADD-EXT	12-Stn. add-on controller (outdoor)
PCW-R	Remote, stand, USB cord and disk

## DIMENSIONS

- Outdoor: H: 13", W: 7", D: 4 1/4"
- Indoor: H: 12 1/8", W: 6 1/8", D: 3"

## SYSTEM REQUIREMENTS

- Windows-compatible PC
- Windows XP Home Edition, XP Professional, Vista or Windows 7 (must have Microsoft .NET Frameworks 3.5 or later)
- Available USB 1.0 (or greater) port
- 900 MHz CPU
- 64 MB RAM and CD-ROM drive
- 20MB free hard disk space
- 1024 x 768 64k color display/monitor (800 x 600 minimum)
- Keyboard and pointing device (mouse)
- Internet connectivity (high speed)

# PCW CONTROL SERIES

COMPUTER-CONTROLLED

EXPERIENCE THE SIMPLICITY OF PCW CONTROL.

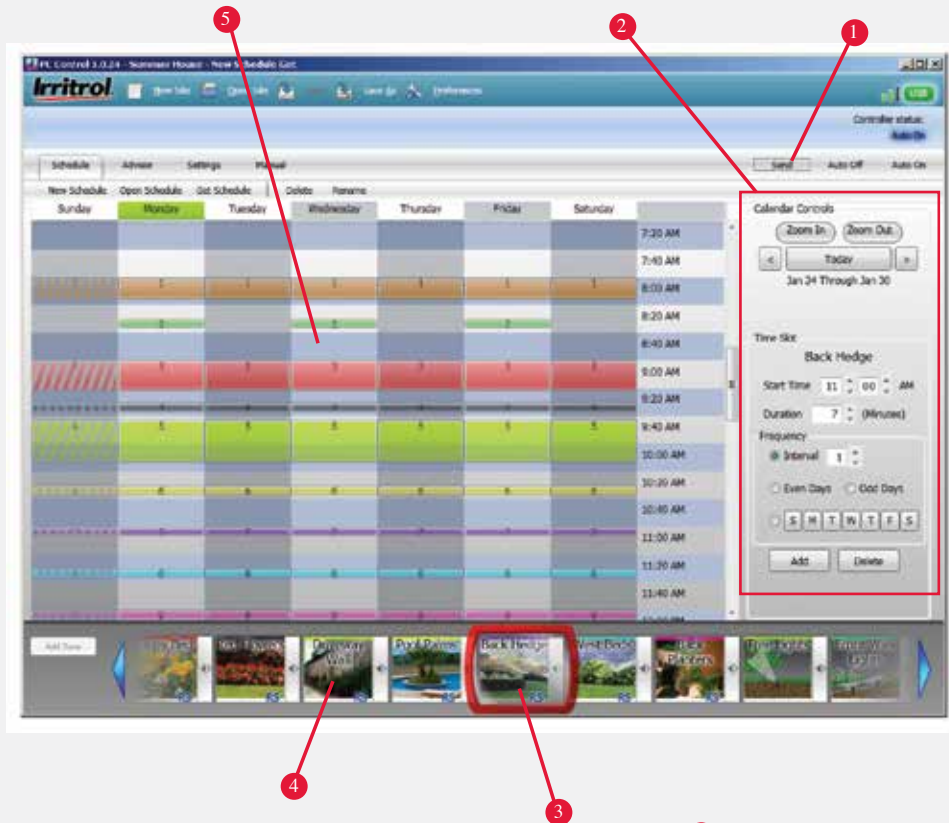

- 1 Send changes to the controller
- 2 "Back Hedge" watering schedule:
  - Start: 11:00 am
  - Run: 7 minutes
  - Day interval "1" (every day)
  - Odd or even water day option
  - Week day watering option
- 3 Current zone selection "Back hedge"
- 4 Zone buttons with digital photos of each zone
- 5 Scheduling calendar:
  - Shows each zone's:
    - Water days
    - Start time
    - Watering duration
  - Drag and drop zones on the calendar with your cursor

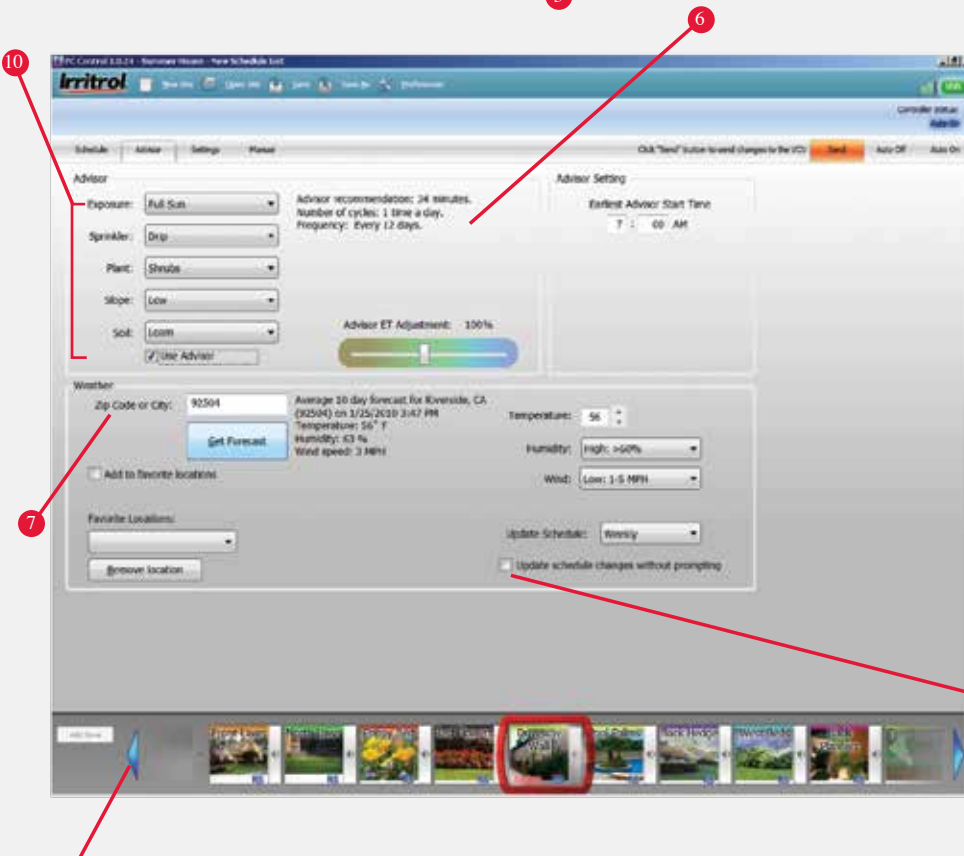

- 6 Provides a recommended watering program each time it receives a weather update
- 7 Enter zip code and send for online weather data
- 8 Move zone buttons for selection
- 9 Automatically update schedule using weather information just received
- 10 Enter site-specific information for each zone

## EASY MAINTENANCE USING HAND-HELD REMOTE



Easy system maintenance or troubleshooting using the convenient hand-held remote. Make on-site schedule changes with your laptop and remote without garage access.

## CUSTOMIZE YOUR SEMI-AUTOMATIC PROGRAMS



## OPTIONAL ACCESSORIES

- SR-1 pump start relay
- RS1000 wireless RainSensor™
- RFS1000 wireless rain/freeze sensor
- RS500 wired RainSensor™

## LATEST SOFTWARE UPDATE

- Software version: On HELP page, click on UPDATES for latest version of software
- Send individual schedules over the Internet
- Diagnostic circuit breaker alerts user to short circuits right on zone photos
- Available as a FREE online upgrade

## SPECIFYING INFORMATION

PCW-12-XXX-XXX

MODEL	STATIONS	CONFIGURATION	OPTIONS
PCW - PCW Control Controller	12 - 12 Station	EXT - Outdoor INT - Indoor	ADD - Add-on controller PAK - Includes remote and disk

Example: A PCW Control 12 station, outdoor model = **PCW-12-EXT-PAK**



PCW-12-INT-PAK  
(includes transformer)

# MC-E (Blue) SERIES



## 4, 6, 8, 12, 18, 24, 30, 36, 42 AND 48 STATION, OUTDOOR/INDOOR

We've taken the industry standard for commercial irrigation control and made it better. The Irritrol® MC-E, in its rugged, lockable, vandal-proof steel cabinet, now boasts a modernized feature set that includes; the scheduling versatility of 8 independent programs, state-of-the-art flow monitoring, program looping, and new blue face panels. And now, the MC-E blue model is compatible with Irritrol's new CLIMATE LOGIC® Wireless Weather Sensing System to automatically adjust the controller's program based on each day's weather. We've also added a 48-station model to the family. From small to large landscapes, the new MC-E has got what it takes to meet the growing demands of today's commercial irrigation applications.

## KEY FEATURES & BENEFITS

### CLIMATE LOGIC® COMPATIBLE

On-site wireless weather sensing option

### FLOW MONITORING WITH DIAGNOSTICS AND 3 TYPES OF ALARMS (requires station #1 for a N/O master valve circuit)

Protects the system and saves water by detecting, reporting and handling high flow and unscheduled flow events

### MODELS WITH STATION COUNTS FROM 4 UP TO 48

Provides irrigation control for any size project

### COMMERCIAL-GRADE, HEAVY-DUTY, LOCKABLE, WEATHER RESISTANT CABINETS AND PEDESTALS

For long service life in demanding commercial and "heavy turf" applications

### BACKWARD COMPATIBLE FACE PANEL TO EXISTING MC PLUS-B CABINETS ON SITE

Allows field upgrades to the new MC-E while leaving cabinet/pedestal in place

### ADDED FEATURES

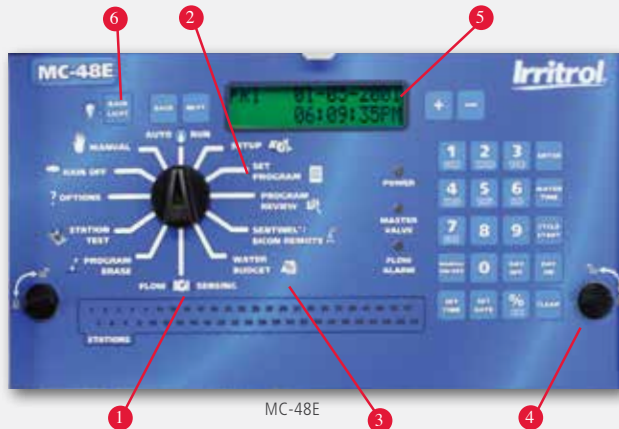

- 1 Flow monitoring and diagnostics
- 2 Eight independent programs
- 3 Global water budget
- 4 Quick-disconnect face panel
- 5 32-character, dot matrix LCD display
- 6 LCD backlight

### CLIMATE LOGIC® COMPATIBLE



Optional CLIMATE LOGIC one month view.

### EASY UPGRADE TO MC-E (blue)



Includes a lower access panel with each MC-E-PAN

### SPECIFYING INFORMATION

MODEL	NUMBER OF STATIONS
MC - MC Series	4 - 4 Station
	6 - 6 Station
	8 - 8 Station
	12 - 12 Station
	18 - 18 Station
	24 - 24 Station
	30 - 30 Station
	36 - 36 Station
	42 - 42 Station
48 - 48 Station	
Example: A 24 station MC-E controller = <b>MC-24E</b>	

### ADDED FEATURES

- Backlit, 2-line, 32 character, dot matrix LCD display
- Terminals for flow sensor, stop sensor and start sensor
- Password protection option for programming schedules
- Optional remote alarm to warn of an undesirable flow event
- "Super Cap" to maintain time/date up to 48 hours (no battery required)
- Looping option per program (Start Time, Stop Time & Delay between loops)
  - Pump/MV option of ON or OFF during delay
- Flow sensing based on Irritrol® or Data Industrial PVC-TEE mounted flow sensor models & sizes
- Quick disconnect face panel
- Five-year warranty

### OPERATING SPECIFICATIONS

- Watering day cycles per program:
  - Any days of the week
  - Odd or Even date watering
  - Day intervals from 1- 60 days
- Station run times:
  - 0-59 seconds in 1-second increments
  - 1 minute to 24 hours in 1-minute increments
- Global water budget:
  - 0% to 255% in 1% increments

### ELECTRICAL SPECIFICATIONS

- Transformer input: 120V ac, 60 Hz
- Transformer output: 24V ac, 2.08 amps (50 VA)
- Maximum output per station: 24V ac, 1.24 amps
- Maximum output to valves: 24V ac, 1.68 amps (including master valve)

### MODELS

Model	Description
MC-4E	4 -Station, wall mount, fits P-2B Pedestal
MC-6E	6 -Station, wall mount, fits P-2B Pedestal
MC-8E	8 -Station, wall mount, fits P-2B Pedestal
MC-12E	12 -Station, wall mount, fits P-2B Pedestal
MC-18E	18 -Station, wall mount, fits P-6B Pedestal
MC-24E	24 -Station, wall mount, fits P-6B Pedestal
MC-30E	30 -Station, wall mount, fits P-6B Pedestal
MC-36E	36 -Station, wall mount, fits P-6B Pedestal
MC-42E	42 -Station, wall mount, fits P-6B Pedestal
MC-48E	48 -Station, wall mount, fits P-6B Pedestal

### DIMENSIONS

- **4-12 Station:** H: 9 3/4", W: 10 1/2", D: 4 1/4"
- **18-48 Station:** H: 12", W: 14 1/4", D: 4 3/4"

### OPTIONAL ACCESSORIES

- CL-100-Wireless Weather Sensing System
- RS1000 wireless RainSensor™
- RFS1000 wireless rain/freeze sensor
- RS500 wired RainSensor™
- Pedestal mounts (P-2B: 4- to 12-station models; P-6B: 18- to 48-station models)
- SR-1 pump start relay
- CRR remote series (R-100-KIT)
- PVC-TEE flow sensors

# IBOC<sup>®</sup> PLUS SERIES



## 4, 8 AND 12 STATION, OUTDOOR

Designed to control commercial irrigation systems with no A.C. power, the Irritrol<sup>®</sup> IBOC<sup>®</sup> Plus controller operates with a battery or it's optional SPC-2 solar power converter. For dependable performance in commercial applications, the IBOC Plus features a steel cabinet and key/lock door as well as an optional steel locking pedestal for free-standing installations.

## KEY FEATURES & BENEFITS

### BATTERY, 6V DC POWER OR OPTIONAL SOLAR POWER

Provides operation in areas with no AC power

### COMMERCIAL-GRADE, LOCKABLE STEEL CABINETS AND PEDESTALS

For vandal resistance and longer service life

### THREE INDEPENDENT PROGRAMS

Offer concurrent operation capability and scheduling flexibility

### ODD/EVEN DAY CALENDAR WITH DAY EXCLUSION; SEVEN-DAY CALENDAR; OR ONE TO 62 SKIP DAYS

To match water restrictions and varied plant water requirements

### NON-VOLATILE MEMORY

Retains all program data for reliable operation

### PROGRAM CYCLE LOOPING

Provides continuous program repeat operation within a selectable watering window for "grow in" periods

### SOLAR OPTION

#### Solar power converter can be mounted up to 80 feet from IBOC Plus (SPC-2 option, sold separately)

Simple mounting on top of any IBOC Plus controller model or mounted up to 80 feet from the controller

**Maintenance-free gel cell battery:** (3-year life) inside solar converter

**Solar load ratio:** 6-to-1 (provides full power to IBOC Plus with only two hours of direct sunlight per day)

**Output:** 25-27 V dc/50mA

**Solar amp/hrs. per day:** 600mA, typical

**Load amp/hrs. per day:** 100mA, typical

**Operation temperature:** -22°F to +140°F (-30°C to +60°C)

**Storage temperature:** -40°F to +185°F (-40°C to +85°C)

**SOLAR POWER CONVERTER REMOTE MOUNTING WIRE SIZING**

Wire size (Awg)	16	14	12
Distance (ft.)	30	50	80

**CONTROLLERS TO VALVES**

Wire size (Awg)	20	18	16	14	12
Distance (ft.)	400	600	1000	1600	2400

**OPTIONAL SOLAR POWER CONVERTER (SPC-2)**

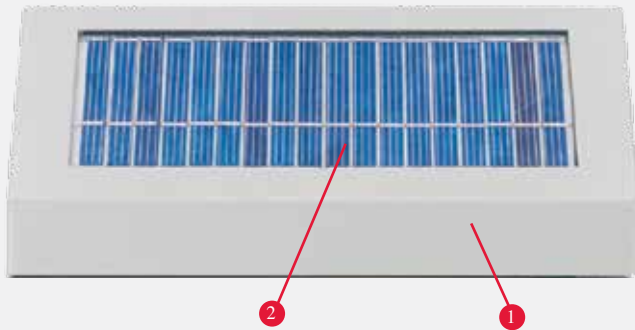

- 1 Vandal-resistant, metal housing
- 2 Internal maintenance-free gel-cell battery

**SPECIFYING INFORMATION**

IBOC - XXPLUS

MODEL	NUMBER OF STATIONS
IBOC - IBOC PLUS	4 - 4 Station Plus
	8 - 8 Station Plus
	12 - 12 Station Plus

Example: An IBOC 12 station = **IBOC-12PLUS**

**PEDESTAL OPTIONS**



**PEDESTAL – P-2B**  
 H: 27 5/8", W: 10 3/4", D: 3 1/4", WT: 11 lbs

**PEDESTAL – P-6B**  
 H: 35", W: 14 1/4", D: 4 1/16", WT: 21 lbs

**ADDED FEATURES**

- Programmable "Rain Delay" postpones automatic operation for up to 30 days
- Program review and erase
- Large, easy-to-read LCD displays English or Spanish
- One- to 10-minute programmable test cycle
- Fully programmable manual cycle acts like a fourth temporary program
- Selectable, programmable master valve
- 365-day calendar with automatic leap year adjustment
- Start-time stacking within each program
- Station stacking for up to three stations plus master valve at one time
- Enhanced lightning protection
- Electronic circuit breaker detection for open and shorted conditions
- Battery capacity displayed in remaining percentage
- Optional RainSensor™ input selectable by program
- Five-year warranty

**OPERATING SPECIFICATIONS**

- Station run times: 1-minute to 23 hours, 59 minutes
- Start times: 8 per program for up to 24 daily starts
- Watering schedule: 7-day calendar, odd/even day with day exclusion or 1-62 skip days
- Water budgeting: 10-200% in 10% increments

**ELECTRICAL SPECIFICATIONS**

- Powered by one 6-volt alkaline battery (not included) or one SPC-2 (solar power converter) sold separately
- Output: 24 V DC latching
- Master valve output 24 V DC latching
- Rain sensor input selectable per program
- Irritrol®, Hardie® and Richdel® valves must be converted from AC with 24 V DC latching solenoids (DCL)
- Maximum operating pressure: 120 psi

**MODELS**

Model	Description
IBOC-4PLUS	4 -Station, fits P-2B Pedestal
IBOC-8PLUS	8 -Station, fits P-2B Pedestal
IBOC-12PLUS	12 -Station, fits P-2B Pedestal

**DIMENSIONS**

- **IBOC Plus:** H: 9 1/4", W: 10 3/4", D: 5 1/4"
- **SPC-2:** H: 4 9/16", W: 10 3/4", D: 3 3/8"

**OPTIONAL ACCESSORIES**

- RS500 wired RainSensor™
- P-2B standard pedestal
- SPC-2 Solar power converter (includes batteries)
- DCL DC latching solenoid

# SENTAR II™



## 6, 12, 18, 24, 30 AND 36 STATION, OUTDOOR/INDOOR

The Sentar II has long been noted as the “workhorse” of irrigation controllers. It offers advanced control features for a fraction of the cost of similar models. Designed with the irrigation manager in mind, the Sentar II protects landscapes by offering; rain sensing, flow sensing, and cycle and soak scheduling on any of 4 fully independent programs.

## KEY FEATURES & BENEFITS

### FOUR INDEPENDENT PROGRAMS

Five start times for a total of 20 possible start times per day

### COMMERCIAL-GRADE, LOCKABLE STEEL & STAINLESS STEEL CABINETS AND PEDESTALS

For vandal resistance and longer service life

### CYCLE AND SOAK

To eliminate runoff and conserve water

### SEVEN DAY WEEK OR SKIP-BY-DAY SCHEDULING

To match water restrictions and varied plant water requirements

### NON-VOLATILE MEMORY

Retains all program data indefinitely during outages or shutdowns

### PROGRAMMABLE OVERLAP PROTECTION

Allows programs to run one after the other (stack mode) or at the same time (no stack mode)

### BUILT-IN REMOTE JACK

For use with Irritrol Pro Max™ remotes and optional permanent mount receiver



## ADDED FEATURES

- Flow sensing allows for total flow control and break detection (requires flow sensor)
- Watering time(s) for each station can be set from 1 minute to 9 hrs 59 mins in 1 minute increments
- Quick Stations allow for rapid programming of a block of stations with the same watering time
- Water days for each program may be based on seven day week or a skip-by-day routine allowing a program to skip from 1 to 30 days between watering
- Programmable rain shut down allows the selection of the number of days (1 to 7) the controller will remain in rain shut down before restoring automatic watering
- A "real time" clock holds the actual time during power outages without batteries
- The Review feature brings all the information for a given program(s) to the displays with simple push of the Review Button
- Multiple displays provide a truly simple way of programming and information recall
- Manually activated program cycle to run a program independent of its programmed start time and water days
- Automatic field wire fault detection enables the controller to sense a short circuit in the field wire and instantly turn off that station, report the fault and move to the next programmed station. No fuses or reset button to be concerned with
- Manual Rain Switch (auto-off) turns off all stations without disturbing the program(s).
- Heavy-duty 18-gauge steel enclosure with powder coated finish. Also available in Stainless Steel
- Extra heavy-duty lightning and surge protected models available for areas where lightning is a concern
- Water budgeting by increasing or decreasing station run times in 1% increments from 0% to 300% by program
- Limited five-year warranty

## ENCLOSURES

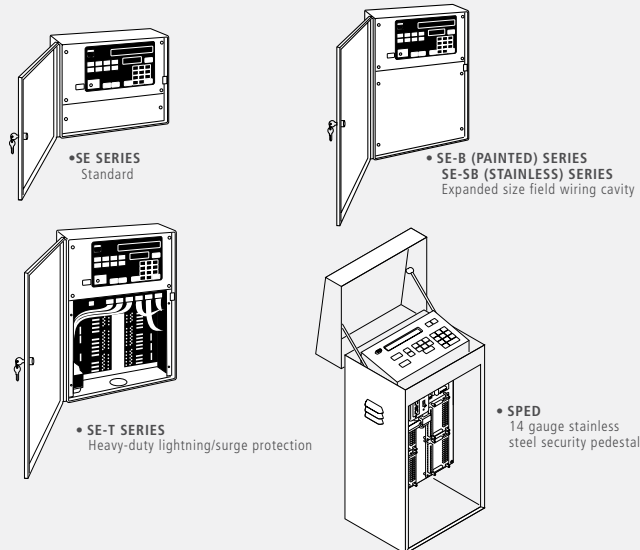

## OPERATING SPECIFICATIONS

- Programmable master valve and pump allows the master valve or pump to be assigned to any program
- Programmable time delay between stations (from 1 to 256 seconds) permits slow-closing valves to fully close
- Programmable security code allows entry of a 1-4 digit number as a security code to prevent access by unauthorized personnel
- Programmable rain sensor can be assigned on a per program basis
- Programmable alarm to enable or disable an audible alert in the event of a field wire fault

## ELECTRICAL SPECIFICATIONS

- Input power required: 105-130V ac, 50/60 Hz, 0.5 amp maximum, 0.1 amp idle
- Output power: 24V ac 1.5 amps maximum total output (36VA) 1 amp per station or master valve
- UL, CUL and FCC Approved

## DIMENSIONS

- **SE Series:** 10" x 13" x 4 1/2"
- **SE-B & SB Series:** 17 1/2" x 13" x 4 1/2"
- **RMPED-1:** 16" x 34" x 16"

## OPTIONAL ACCESSORIES

- PMRKIT: Permanent mount receiver kit for use with Pro Max™ remote
- RMPED-1: Outdoor pedestal

## SPECIFYING INFORMATION

MODEL	# OF STATIONS	OPTIONAL ENCLOSURE TYPE	OPTIONAL SURGE PROTECTION
RME	6 12 18 24 30 36	B=Large painted wall mount SB=Large stainless wall mount SPED=Stainless steel large enclosure pedestal	T=Surge protection

Example: A 36-station Sentar II with a large stainless wall mount option and surge protection = **RME36SE-SB-T**

# RAIN MASTER® EAGLE™



## 6, 12, 18, 24, 30 and 36 STATION, OUTDOOR/INDOOR

The Rain Master Eagle™ combines classic controller programming with cutting edge features, including an optional weather station. Optimized for simplicity, the Eagle is ideal for use by ground maintenance personnel and landscape managers that require a fully automated, “Smart” ET weather-based irrigation controller.

## KEY FEATURES & BENEFITS

### FOUR INDEPENDENT PROGRAMS

With five selectable start times for a total of 20 possible irrigation cycles per day

### WATER DAYS FOR EACH PROGRAM

Can be based on a seven-day cycle, a skip-by-day cycle or odd/even water days

### PROGRAMMABLE MASTER VALVE

To utilize and control a master valve on a per program basis

### CONFIGURABLE MASTER VALVE TYPE

To select either a normally open master valve or a normally closed master valve

### EVAPOTRANSPIRATION (ET) BASED SCHEDULING

Maximizes water saving and irrigation efficiency

### FLOW SENSING AND CONTROL

Monitors system flow and shuts off master valve when high flow occurs

## ADDED FEATURES

### Water Saving Features

- Evapotranspiration (ET) based scheduling.
- Flow sensing and control.
- Percentage adjustment on a per program basis (1%-300%, in 1% increments) to allow an increase or decrease of all station runtimes within that program.
- Programmable rain shut off in order to delay the start of irrigation after a rain storm.
- Manual rain switch (automatic watering – no watering).
- Connectivity for any one of the following; rain, moisture or freeze sensor device.
- Selectable cycle-and-soak or conventional start times on a per-program basis.

### Diagnostic and Fault Detection

- Automatic field wire fault detection enables the controller to sense a short in the field wire and instantly turn off that station.
- Non-volatile memory to retain the program(s) and controller information during power outages or seasonal shut downs.
- Intelligent resumption of program execution after power outages to ensure that program starts are not lost.

### Convenience Features

- Keyboard layout is easy to understand and use; provides ease of use during programming and review.
- During program execution the controller displays the executing program number, the flow in GPM, and the station runtime countdown in hours, minutes and seconds.
- Programmable Controller Security Access code to prevent unauthorized use or modifications to the controller's program.

### Flow Capabilities

- Automatic detection of main line water breaks.
- Automatic detection of unscheduled or no-flow water conditions.
- Automatic high-flow station alarm.
- Controller utilizes automatic LEARN mode for setting individual station flow limits.
- Intelligent flow-limit processing for concurrent station operation.
- Water usage meter indicates total water used by the controller.

## EVAPOTRANSPIRATION (ET) FEATURES OF THE IRRITROL® RAIN MASTER® EAGLE™

- The ability to input and store Historical ET data on a monthly basis (12 months).
- The ability to use any one of four different ET sources as the basis for its ET calculations:
  1. Historical ET data
  2. Manually-entered ET data
  3. Rain Master ET measurement device or equivalent
  4. Downloaded ET data from the Internet (requires optional Rain Master® iCentral™ hardware)
- The ability to automatically re-compute station runtime, utilizing the current ET information.
- Ability to display the current adjusted runtime as a percent of the base runtime for all ET-enabled programs.

## OPERATING SPECIFICATIONS

- Four independently controllable irrigation programs with five selectable start times for a total of 20 possible irrigation cycles per day
- Water days for each program can be based on a seven-day cycle, a skip-by-day cycle or odd/even water days
- Programmable master valve to utilize and control a master valve on a per program basis.
- Configurable master valve type to select either a normally open master valve or a normally closed master valve
- Programmable pump independent of the master valve on a per program basis
- Programmable stacking or non-stacking operation of the programs

## ELECTRICAL SPECIFICATIONS

- Input power required: 105-130 V ac, 50/60 Hz, 5 amp maximum, 1 amp idle
- Output power required: 24 V ac 1.5 amps maximum total output or (36 VA) 1 amp per station or master valve
- UL, CUL, and FCC approved

## DIMENSIONS

- **Station EG model:**  
H: 10", W: 13", D: 4½"
- **Station EG-B & SB model:**  
H: 17½", W: 13", D: 4½"
- **Station SPED model:**  
H: 34", W: 16", D: 16"

## OPTIONAL ACCESSORIES

- RM-WETHR-ETRS: Weather station for direct ET measurements
- Flow sensor (Brass & Plastic)
- Built-in remote control capability with Pro Max™ Remote
- Heavy-duty lightning protection (T-optional)

## SPECIFYING INFORMATION

MODEL	# OF STATIONS	OPTIONAL ENCLOSURE TYPE	OPTIONAL SURGE PROTECTION
RME	6 12 18 24 30 36	W=Small painted wall mount B=Large painted wall mount SB=Large stainless wall mount SPED=Stainless steel large enclosure pedestal	T=Surge protection
Example: A 24-station Rain Master® Eagle™ in a large stainless wall mount enclosure and surge protection = <b>RME36SE-SB-T</b>			

# RAIN MASTER® TWICE™ 2-WIRE



## UP TO 36 STATIONS, OUTDOOR/INDOOR

Unlike other two-wire systems, the Irritrol® Rain Master Twice 2-wire protocol provides a two-way communication link between the controller, decoders and valves. This provides the means for testing and diagnostic capabilities within the 2-wire system. The simplicity of the 2-wire field installation, coupled with the enhanced capability of the Rain Master 'E' series controllers, sets a new precedent for 2-wire control within the irrigation industry.

## KEY FEATURES & BENEFITS

### EVAPOTRANSPIRATION (ET) BASED SCHEDULING

Maximizes water saving and irrigation efficiency

### FLOW SENSING AND CONTROL

Monitors system flow and responds to upper, lower, unscheduled and no flow conditions

### 2-WIRE INTERFACE MODULE

Provides 2-wire capability for any Irritrol Rain Master Eagle controller

### DECODER TWO-WAY COMMUNICATION

Provides troubleshooting diagnostics to retain system integrity

### PROGRAMMABLE DECODERS

Provides flexibility in programming decoder identification

### TWICE LOOP CONFIGURATION

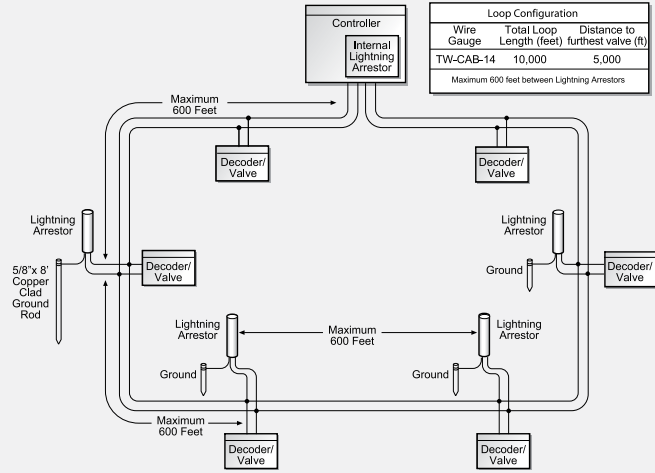

### TWICE STRAIGHT LINE CONFIGURATION

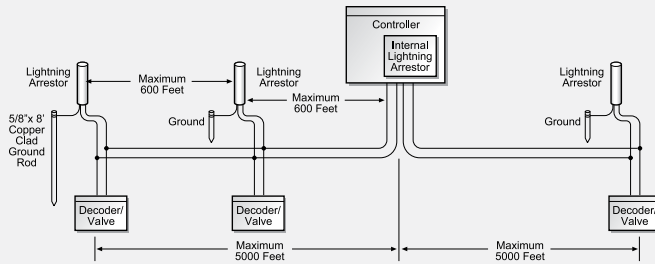

Straight Line Configuration	
Wire Gauge	Total Wire Length (feet)
TW-CAB-14	5,000
Maximum 600 feet between Lightning Arrestors	

### TWICE WIRE CONNECTION DETAIL

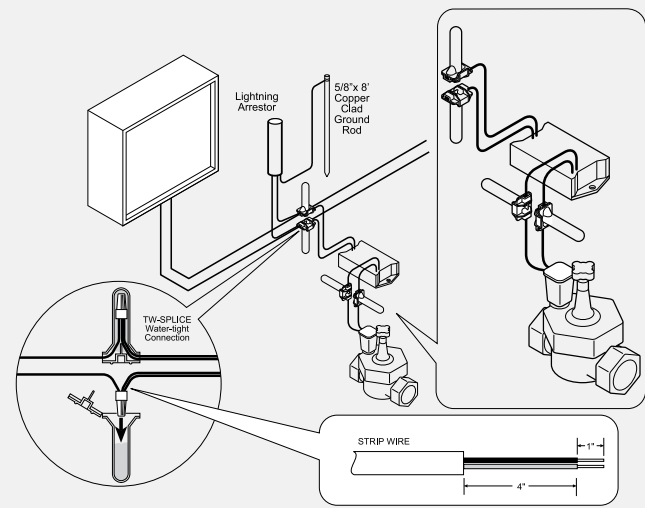

### MODULES

- Easy-to-read LED status indication for every command
- LED also displays valve activation and diagnostic reporting
- Troubleshooting capabilities:
  - LED decoder "active" indication
  - LED valve power "on" indication
  - Two-way communication verification

### DECODERS

- Each decoder has a unique address (programmable at the interface module)
- Decoders will automatically shut off if communication is lost
- Wire fault detection automatically shuts down any valve
- Valves can be operated up to 100' radius of the decoder

### ELECTRICAL SPECIFICATIONS

- Input power: 105-130V ac, 50/60 Hz, 0.5 amp maximum, 1 amp idle
- Output power: 24V ac, 1.5 amps maximum total output or (36 VA) 1.0 amp per station or master valve
- UL, CUL, and FCC approved

### SPECIFYING INFORMATION

Model	Controller Description
TW-EG36	Rain Master Eagle, up to 36 decoders, rolled steel wall mount
TW-EG36-SB	Rain Master Eagle, up to 36 decoders, stainless steel wall mount
TW-EG36-SPED	Rain Master Eagle, up to 36 decoders, 14 gauge stainless steel security pedestal

### DIMENSIONS





- **TW model:** H: 10" W: 13" D: 4.5"
- **TW & SB model:** H: 17.5" W: 13" D: 4.5"
- **TW-SPED model:** H: 34" W: 16" D: 16"

### OPTIONAL 2-WIRE DECODERS AND ACCESSORIES

Model	Description
• TW-D-1	Single valve AC decoder
• TW-D-2	Dual valve AC decoder
• TW-D-4	Quad valve AC decoder
• TW-LA-1	Lightning arrester used every 600 feet
• TW-SPLICE	14-gauge water-tight connectors
• TW-CAB-14	14-gauge (red/black) Polycoated (blue) wire

# SENSORS & REMOTES

For over a decade, Irritrol has led the industry with its wireless sensor and remote technology. Irritrol sensors and remotes are designed to save time on installation, save water through automatic controller adjustments and ultimately save money.

AT-A-GLANCE				
	RS500	RS1000	RFS1000	CLIMATE LOGIC®
	pgs 30-31	pgs 30-31	pgs 30-31	pgs 32-34
TRANSMISSION RANGE (LINE-OF-SIGHT)		Up to 500'	Up to 500'	1000'
RAINFALL ADJUSTMENT (1/8" - 3/4")	●	●	●	●
25' CONTROL WIRE	●	Wireless	Wireless	Wireless
AUTOMATIC RESETTING BYPASS		●	●	
POWER FAILURE PROTECTION		●	●	●
DIGITAL FREEZE SENSOR			●	●
REPLACEABLE BATTERY		●	●	●
SIGNAL STRENGTH INDICATOR		●	●	●
WATER BUDGETING				●
2-YEAR'S WATER BUDGET HISTORY				●
VERSATILE MOUNTING OPTIONS	●	●	●	●
SOLAR SENSOR				●
ADJUSTABLE DRY-OUT RATE FOR RESET DELAY	●	●	●	●
WEATHER-FOLLOWING BY SITE LOCATION				●
WORKS WITH ALL 24 V CONTROLLERS	●	●	●	
COMMUNICATES WITH MULTIPLE RECEIVERS		●	●	●
OPTIONAL REMOTE CONTROL				●
WARRANTY	5 years	3 years	3 years	5 years

<b>AT-A-GLANCE</b>		
	<b>CRR</b>	<b>PRO-MAX™</b>
	pgs 38-39	pgs 40-41
<b>TRANSMISSION RANGE (LINE-OF-SIGHT)</b>	Up to 1000'	Up to 1.5 Miles
<b>COMBINATION RECEIVER/ TRANSMITTER/CONNECTOR</b>	●	
<b># OF PROGRAMMABLE ADDRESSES/PINS</b>	Up to 9999	Up to 999
<b>MAXIMUM STATIONS TO CONTROL</b>	48	48
<b>QUICK CONNECT SYSTEM</b>	●	●
<b>INDEPENDENT CONTROL OF MASTER VALVE OR PUMP</b>		●
<b>SETTABLE STATION LIMIT ON TRANSMITTER</b>	●	●
<b>TURN TRANSMITTER ON OR OFF</b>	●	●
<b>TURN STATION ON OR OFF</b>	●	●
<b>MANUAL STATION ADVANCE</b>	●	●
<b>PAUSE OR UN-PAUSE CURRENT STATION</b>	●	●
<b>2-MINUTE TEST RUN</b>	●	
<b>TURN ON SPECIFIC PROGRAM</b>	●	
<b>COMPATIBLE WITH ALL 24V CONTROLLERS</b>		●
<b>PM-UADAPT, UNIVERSAL CABLES INCLUDED</b>		●
<b>CONNECTOR HARNESSSES AVAILABLE FOR PERMANENT MOUNT</b>		●
<b>INDIVIDUAL RECEIVERS AVAILABLE FOR PERMANENT MOUNT</b>	●	
<b>CARRYING CASE INCLUDED</b>		●
<b>BATTERY REQUIREMENT FOR TRANSMITTER</b>	1 each, 9-volt	1 each, CR-P2 pack
<b>WARRANTY</b>	5 years	3 years

# RAINSENSOR™ SERIES

RAIN AND FREEZE SENSORS



## WIRED AND WIRELESS SENSORS

Taking water management to the next level, the proven Irritrol® RainSensor™ Series makes watering in the rain a mistake of the past. The reliable wireless and wired rain sensors conserve water by preventing irrigation during or after sufficient rainfall, while the wireless rain/freeze sensor also helps reduce vegetation damage and icing conditions when the temperature drops below a predetermined set point. With its compact design and host of convenient features, the RainSensor Series is the perfect complement to any standard controller.

## KEY FEATURES & BENEFITS

### WIRELESS MODELS

Require less labor for the installer

### CONSTANT COMMUNICATION BETWEEN TRANSMITTER AND RECEIVER

Assures that even after a controller power outage, the controller is continually updated with the sensor's "wet" or "dry" status

### VERSATILE MOUNTING OPTIONS

Requires no special tools – Quick-Clip™ gutter bracket and ½" conduit adapter included

### SIGNAL STRENGTH INDICATOR

Ensures correct installation, communication link and signal integrity (wireless models)

### SMART BYPASS™ FOR EASY SYSTEM OVERRIDE

Allows for temporary deactivation while automatically resetting on next activation (wireless models)

### FULLY ADJUSTABLE SHUTOFF POINTS

From 1/8" to 3/4" of accumulated rainfall

### DRY-OUT RATE ADJUSTMENT FOR RESET DELAY

Allows for setting the ideal dryout time

### PATENTED WIRELESS TECHNOLOGY

Unsurpassed by the competition



## PATENTED WIRELESS TECHNOLOGY

Press once to temporarily deactivate rain sensor; automatically resets on next activation

Illuminates "RED" when the rain sensor is activated

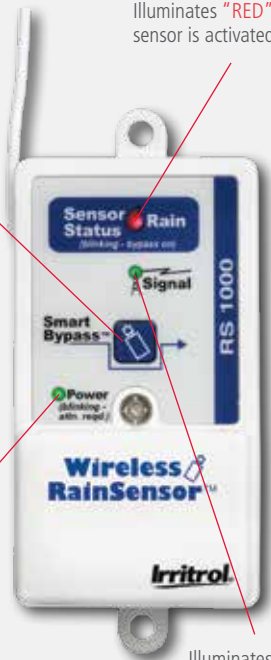

Blinking light alerts user when attention is required, e.g., need batteries replaced, no communication

Illuminates "GREEN" to ensure a good signal

## VERSATILE MOUNTING OPTIONS: (ALL IN ONE SKU)



Gutter mount



Surface mount



Pole mount

## SPECIFYING INFORMATION

MODEL	CONNECTION
RS - Rain Sensor	500 - Wired
RFS - Rain/Freeze Sensor (wireless only)	1000 - Wireless

Example: A wireless rain/freeze sensor = **RFS1000**

## ADDED FEATURES

### RS1000/RFS1000

- Compatible with nearly all controllers
- Visual sensor status and alert indicators verify consistent operation
- Slide/snap-on cover provides additional protection to weather-proof receiver from the elements
- Power failure memory protection
- Three-year warranty

### RFS1000

- Rain and freeze sensors fully integrated into one unit
- Highly accurate 41°F digital activation point

### RS500

- Compatible with virtually all controllers
- 25-foot cable (UV-resistant, white jacket included) provides installation flexibility
- Easy, tool-free conversion to normally open operation
- Five-year warranty

## OPERATING SPECIFICATIONS

- Sensor type: industry-standard hygroscopic discs
- Rain sensitivity; adjustable nominal 1/8" to 3/4"
- Operating temperature: -20°F to 120°F
- Housing material: UV-resistant engineered polymer
- Wireless only features:
  - Transmission range: up to 500' line-of-sight
  - Battery: Two CR2032 3V cells, 5-year life (typical)
  - Frequency: 418MHz

## ELECTRICAL SPECIFICATIONS

- Receiver power: 22-28 V ac/V dc, 100mA (to be used with Class 2, UL-approved (transformer))
- Load rating: normally open or normally closed — 3A @ 24 V ac
- UL Listed, FCC, CE, IC

## MODELS

Model	Description
RS1000	Wireless RainSensor™
RFS1000	Wireless rain/freeze sensor
RS500	Wired RainSensor™

## DIMENSIONS

- **Transmitter:** H: 1 1/2", W: 1 3/4", D: 3 3/4"
- **Receiver:** H: 1 1/2", W: 1", D: 3"

## OPTIONAL ACCESSORIES

- RS1000-RX rain receiver for multiple controllers
- RFS1000-RX rain/freeze receiver for multiple controllers
- RSCAP cap/disc/spindle assembly
- RSBATT-TX battery pack (includes 2 batteries)



## WIRELESS WEATHER SENSING SYSTEM

For simple, water-saving, weather-following, automatic irrigation control, Irritrol® introduces the Climate Logic® Weather Sensing System. Consisting of three components—a wireless transmitting weather sensor for installation outdoors, a receiver module to attach to the Irritrol controller, and an SD card with the 10-year, local historical weather information—the system monitors weather data, transmits it to the module, then alters the controller’s program to “follow the weather”. As for compatibility, the Climate Logic Weather Sensing System works with the Rain Dial®-R, Total Control®-R, KwikDial® and the new MC-E controllers (blue model).

## KEY FEATURES & BENEFITS

### BUILT-IN RADIOS

For easy, wireless installation with less labor than wired systems

### TEMPERATURE SENSOR FOR MONITORING AIR TEMPERATURE

Shuts system off in cold weather

### RAINSENSOR™

Adjustable for amount of precipitation to shut off system

### SOLAR SENSOR

Monitors the amount of the landscape site’s sun exposure

### RECEIVER MODULE

- Connects to the controller with a single plug-in cord. No bundle of wires to individually attach
- Converts historical and today’s data from the weather sensor to percent of the hottest month’s watering time to apply
- Appropriately alters the controller’s water budget

### WEATHER SD CARD

Contains the 10-year, historical weather information for North America with location access by zip code or latitude/longitude

**COMPATIBLE WITH IRRITROL® RAIN DIAL®-R, IRRITROL TOTAL CONTROL®-R, KWIKDIAL® AND MC-E "BLUE" CONTROLLERS AND MORE**



**CLIMATE LOGIC® KIT**



**SPECIFYING INFORMATION**

CL - XXX - WIRELESS

MODEL	CONNECTION
CL - Climate Logic	100 - Receiver and transmitter kit

Example: a wireless system with sensor & module = **CL-100-Wireless**

\* One CL-W1 weather sensor/transmitter can communicate with several CL-M1 receiver modules and their controllers.

**OPERATING SPECIFICATIONS**

- 1,000' line-of-sight signal range
- Compatible with the following Irritrol controllers:
  - Rain Dial-R Series and earlier Rain Dial (Blue)
  - Total Control-R Series
  - KwikDial Series (with adapter cable CMR-ADP)
  - New MC-E Controllers ("blue" model) with CMR-ADP adapter
- One weather sensor can communicate with multiple receiver modules

**MODELS**

Model	Description
CL-100-Wireless	Wireless weather sensor and module
CL-W1	Wireless weather sensor
CL-M1	Wireless receiver module
CL-R1	Remote control (transmitter only)
CL-MR	Mini-receiver (receiver only)
R-100-KIT	Mini remote kit (transmitter & receiver)

**OPTIONAL ACCESSORIES**

- Cable adapter CMR-ADP

**R-100-KIT: REMOTE CONTROL INCLUDES**



With the optional CLIMATE LOGIC® wireless, weather sensing system, the following controllers meet or exceed the performance criteria for the EPA Watersense® label:

- Rain Dial®-R
- Total Control®-R
- KwikDial®
- MC-E "Blue"



Certified by  
ICC-ES

# CLIMATE LOGIC®

## WEATHER-BASED CONTROL SYSTEM



### SD CARD WITH LOCAL WEATHER HISTORY



For the local, 10-year average historical weather information, insert the LOCATION card into the CLIMATE LOGIC module.

### ACCURATE, PIN POINT LOCATION



Instead of guessing at your regional climate type or picking one out from a manual, pin down the site's location by US zip code or by latitude/longitude. Press "SAVE" to upload the area's historical weather information from the SD card.

### KEY FEATURES FOR CLIMATE LOGIC®



CLIMATE LOGIC builds a bar chart showing each day's automatic water budget setting with displayable history of up to two years.



Sensors come pre-matched with their receiver modules. However, for large projects, several modules can be set to listen to one sensor.



On most of the compatible controllers, the installer can select the programs that will "follow the weather" (A only, A&B or A&B&C).



Cold temperature system shutoff and "dry out" period after a rain event are selectable.



The time for the automatic, daily adjustment to the weather is user selectable.

**LISTED BY THE IRRIGATION ASSOCIATION AS A CLIMATOLOGICALLY-BASED, SMART CONTROL SYSTEM WHEN COMBINED WITH ANY COMPATIBLE IRRITROL® CONTROLLER**

# SR-1 PUMP START RELAY



With a lockable, vandal- and weather-resistant case, the Irritrol® SR-1 can be mounted indoors or outdoors to provide reliable switching control for pumps or other electrical devices from the controller.

## KEY FEATURES & BENEFITS

### ELECTRICAL RELAYS FOR BOTH LOW VOLTAGE (24V AC) CONTROL SWITCHING AND HIGH VOLTAGE (120V AC OR 240V AC) MAIN POWER CONTACTS

- Allows remote pump switching using 24V ac output from an irrigation controller's master valve/pump start circuit
- Opens and closes main power contacts for pumps (1HP at 120V ac 1 Phase or 2HP at 250V ac 1 Phase)
- Note: 2HP at 120V ac will exceed maximum amp rating.

### HIGHLY EFFICIENT 0.1 AMP OPERATING REQUIREMENT

Draws less holding power than most solenoid valves

### CAN ALSO BE USED WITH THE IRRITROL PC CONTROL SYSTEM FOR SWITCHING CONTROL OF LOW VOLTAGE LANDSCAPE LIGHTING

Saves the expense of an extra timer and puts irrigation and landscape lighting control in one location on the owner's computer

## ADDED FEATURES

- Enclosed, weather-resistant case  
- Allows the flexibility of indoor or outdoor mounting
- Five-year warranty

## ELECTRICAL RATINGS

- Contacts: Up to 1 HP at 120V ac, 1 Phase  
Up to 2 HP at 250V ac, 1 Phase (20A at 250V ac)
- Coil: 24V ac, 3VA (19V ac Min, 30V ac Max)
- Coil Draw: 0.1Amp

## DIMENSIONS

- H: 9 1/2", W: 6 1/4", D: 3 3/4"

## WIRING DIAGRAMS

### SR-1 AS A LANDSCAPE LIGHTING RELAY

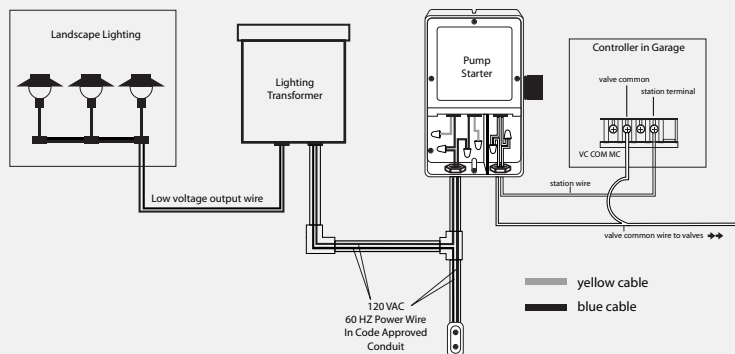

### SR-1 AS A PUMP START RELAY

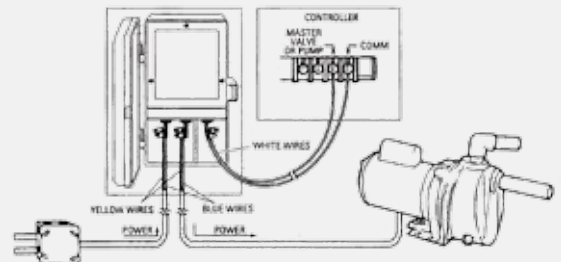

# FLOW SENSORS



BRASS FLOW SENSOR

PLASTIC FLOW SENSOR

IMPELLER FLOW SENSOR ADAPTER

Flow Sensors can be used in conjunction with any Sentar II™ or Rain Master Eagle™ controllers to automatically detect line breaks as well as measure flow limits at point of connection (POC) and individual stations. Should a break or leak occur, the controller will shut down the master valve to prevent significant landscape damage.

## KEY FEATURES & BENEFITS

### BRASS FLOW SENSOR ADAPTER

Sizes 1" thru 2.5". Flow ranges from 2 GPM to 160 GPM, NFPT connections, rated up to 400 psi

### PLASTIC FLOW SENSOR ADAPTER

Sizes 1.5" thru 4". Flow ranges from 5 GPM to 500 GPM, Schedule 80 PVC "slip" glue connections, rated up to 100 psi

### IMPELLER FLOW SENSOR ADAPTER

For all pipe materials and sizes up to 40" in diameter. Mounts in a 2" NPT threaded outlet (NFPT) or pipe saddle (not included). Must be field-calibrated onsite. Flow may be set from 2 GPM to 500 GPM. Call factory for specific settings. 400 psi maximum operating pressure

## FLOW SENSORS SELECTION CHART

FLOW SENSOR MODEL	PIPE CONNECTION SIZE	SUGGESTED OPERATING RANGE	MAXIMUM WATER PRESSURE	K VALUE	OFFSET VALUE	BODY MATERIAL	CONNECTION TYPE
FS-B100	1"	2-40 GPM	400 psi	109	27	Brass	NPT female
FS-B125	1 ¼"	3-60 GPM	400 psi	209	32	Brass	NPT female
FS-B150	1 ½"	4-80 GPM	400 psi	291	24	Brass	NPT female
FS-B200	2"	10-100 GPM	200 psi	750	0	Brass	NTP female with copper male adapter
FS-B250	2 ½"	16-160 GPM	200 psi	1021	370	Brass	NTP female
FS-150	1 ½"	5-100 GPM	100 psi @ 68F	457	0	PVC	Slip
FS-200	2"	10-200 GPM	100 psi @ 68F	776	104	PVC	Slip
FS-300	3"	20-300 GPM	100 psi @ 68F	2268	483	PVC	Slip
FS-400	4"	40-500 GPM	100 psi @ 68F	3752	834	PVC	Slip
FS-INSERT-B	3 to 40 inches	Varies, call factory	400 psi	Varies, call factory		Requires pipe saddle with 2" female NPT	

## WHY USE A FLOW SENSOR?



A \$500 flow sensor could have prevented \$250,000 damage



Irritrol® introduces the Contractor Residential Remote (CRR) with programmable handheld transmitter. The remote provides the installer, or maintenance personnel, the convenience and cost savings of one-person remote access. Use for system checks, troubleshooting, and supplemental watering as needed. An easily accessible mini-USB port on the handheld transmitter allows a computer connection for future upgrades or new product applications so there is no need to purchase a new remote as new features or controllers are added.

## KEY FEATURES & BENEFITS

### LABOR SAVINGS

Makes system testing and maintenance a one person job

### COST SAVINGS

Programmable upgrades to the handheld without buying a new remote

### EXTRA SALES OPPORTUNITY

Remote kit for contractors to offer to the end user

### "9999" SELECTABLE PIN CODES

Individual PIN addresses reduce "cross talk" and unauthorized activity

### COMPATIBLE WITH FOUR SERIES OF IRRITROL CONTROLLERS

The mini-receiver connects to the standard remote ports on 35 models

### PROGRAMMABLE FOR FUTURE UPGRADES OVER THE INTERNET

Computer connectable handheld allows downloadable features/updates

### WORKS WITH THE IRRITROL CLIMATE LOGIC® WEATHER SENSING SYSTEM

Allows remote access through CLIMATE LOGIC

### RANGE UP TO 1,000' (LINE-OF-SIGHT)

Adequate for large residential and small to medium commercial irrigation systems



### THE R-100-KIT INCLUDES:



### FUTURE UPGRADES ONLINE



When Irritrol comes up with new features or a future remote function, you can receive it via email and download the application.

### OPERATING SPECIFICATIONS

- Up to 1,000' range LOS (line-of-sight)
- 9-volt battery powers the handheld
- Controller powers the remote receiver
- Address code "0000 through 9999
- Provides individual station (zone) ON and OFF command
- Set maximum station count to match controller
- "Start Program A, B, or C" capability on some controllers

### COMPATIBLE WITH CONTROLLERS:

- **Irritrol brand**
  - Kwik Dial®
  - Rain Dial®-R
  - Total Control®-R
  - MC-E Blue
- **Toro brand**
  - Custom Command®
  - TMC-212
  - TMC-424-E

### MODELS

Model	Description
R-100-KIT	Transmitter, receiver and cable adapter
CL-R1	Remote transmitter only
CL-MR	Receiver only
CMR-ADP	Cable adapter only

### DIMENSIONS

- **Transmitter:** H: 7", W: 2¾", D: 1¼"
- **Receiver:** H: 5½", W: 2¾", D: 1"

### SPECIFYING INFORMATION

**R-100 - KIT**

MODEL	DESCRIPTION
<b>R-100</b> - Maintenance Remote	<b>KIT</b> - Complete kit

**CL - XX**

MODEL	DESCRIPTION
<b>CL</b> - Climate Logic®	<b>R1</b> - Transmitter <b>MR</b> - Receiver

# PRO MAX™ UNIVERSAL MAINTENANCE REMOTE



## REMOTE CONTROL

The Pro Max Remote Control System eliminates lost time and energy roaming between the field and the controller. It makes light work of system inspections and service work, providing field personnel with complete control over any compatible irrigation controller. At nearly a mile away, the operator can activate a single or multiple stations with the push of a button, permitting immediate observation of system operation and performance. The controller access code feature permits independent control of up to 999 controllers with permanent mount receivers.

## KEY FEATURES & BENEFITS

**COMPLETE REMOTE CONTROL KIT IN A CARRYING CASE**  
Includes transmitter, receiver, connector & cable assembly and a user's guide in one convenient, portable case

**OPERATES WITH SEVERAL SERIES OF IRRITROL & OTHER MANUFACTURERS' 24V AC CONTROLLERS (PROMAX-UA VERSION ONLY)**

Allows maintenance control for a wide variety of controllers

**UP TO 1 MILE RANGE (LINE-OF-SIGHT)**  
Provides operating range for larger projects

**ADDRESSES UP TO 999 INDIVIDUAL CONTROLLERS**  
Allows transmission of commands to specific controllers even though others are within range in permanent mount applications

**REMOTELY CONTROLS UP TO 200 STATIONS**  
Permanent mount or portable models available

**QUICK CONNECTION/DISCONNECTION SYSTEM**  
Allows receiver to be easily moved from one controller to another

**ADDED FEATURES**

- Independent control of master valve and/or pump
- Single or multi-station on capability for testing system hydraulics
- Timed station operation selectable from 1 to 60 minutes
- Turn a program on or off (when used with Sentar II or Rain Master Eagle controllers)
- Small, compact receiver for permanent internal mount
- Detects (provides an audible alert) and protects against field wiring short circuits
- Receiver has built-in safety default to automatically turn station off after 60 minutes
- Audible transmitter and receiver tones verify proper Pro Max operation at all times
- Audible alarm warns of low power condition
- No fuses required
- Limited two-year warranty
- Utilizes three mechanisms to ensure reliable, interference-free communications:
  - A. Digital filters
  - B. Factory set remote access codes
  - C. Frequency Modulation

**PROMAX-UA**



PROMAX-UA

**Includes:**

- Transmitter
- Receiver
- Connector cables for any 24V controller up to 32 stations\*
- Carrying case
- Antennas

\* Not included in standard Pro Max

**OPERATING SPECIFICATIONS**

**PRO MAX Receiver**

- Operating frequency: 154.600 MHz
- Sensitivity: 0.4 microvolt typical
- Operating temperature range: 32 to 140 degrees F°
- Storage temperature range: -4 to 158 degrees F°
- Humidity range: 0 to 90% non-condensing

**PRO MAX Transmitter**

- Operating frequency: 154.600 MHz
- Modulation type: frequency modulation
- Frequency stability: 005%
- Operating temperature range: 32 to 148 degrees F°
- Storage temperature range: -4 to 158 degrees F°
- Humidity range: 0 to 90% non-condensing

**ELECTRICAL SPECIFICATIONS**

**PRO MAX Receiver**

- Power source: 22–32 V ac 50/60 Hz

**PRO MAX Transmitter**

- Battery: CR-P2 lithium 6V (user replaceable)
- Battery life expectancy: 1 season (typical)

**MODELS**

<u>Model</u>	<u>Description</u>
PROMAX	Complete remote kit for Sentar II & Rain Master Eagle controllers
PROMAX-UA	Complete remote kit for any manufacturer's 24V AC controller





**DIMENSIONS**

- **PRO MAX Receiver**  
L: 6 ¼", W: 3 ¼", H: 1 1/16" (less antenna)
- **PRO MAX Transmitter**  
L: 3", W: 1 3/8", H: 5 ½" (less antenna)

**OPTIONAL ACCESSORIES AND ADD-ONS**

<u>Model</u>	<u>Description</u>
PMR-KIT	Permanent mount receiver (preset with user-defined controller access code)
PM-XMTR	Hand-held transmitter
PM-RCVR	Stand alone receiver
PM-UADAPT	Universal adaptor and cables



<b>AT-A-GLANCE COMMERCIAL VALVES</b>					
		<b>200B SERIES</b>	<b>700 SERIES</b>	<b>100 SERIES</b>	<b>100-S SERIES</b>
		pgs 56-57	pgs 58-59	pgs 60-61	pgs 62-63
<b>OPERATION</b>	MANUAL				
	ELECTRIC	●	●	●	●
<b>SIZE</b>	3/4"		●		
	1"	●	●	●	
	1 1/2"	●	●	●	
	2"	●	●	●	●
	3"			●	●
<b>CONFIGURATION</b>	ANGLE	●		●	●
	GLOBE	●	●	●	●
	H-BODY				
<b>INLET/OUTLET</b>	THREADED	●	●	●	●
<b>MANUAL FLOW CONTROL</b>	STANDARD	●	except 3/4"	●	●
	OPTIONAL				
<b>CONSTRUCTION</b>	PVC	●			
	GLASS-FILLED NYLON		●	●	●
<b>PRESSURE REGULATING (OMNIREG®)</b>		●	●	●	●
<b>INTERNAL BLEED</b>		●	●	●	●
<b>EXTERNAL BLEED (FLUSH)</b>		●		●	●
<b>ANTI-CONTAMINATION</b>				102 only	
<b>CONTINUOUS SCRUBBING FEATURE</b>					●
<b>WARRANTY</b>		5 years	5 years	5 years	5 years

# 2400 | 2600 SERIES

ELECTRIC GLOBE/ANGLE



## 1" PLASTIC MODELS

The Irritrol® 2400 Series globe and 2600 Series angle valves are popular with users because of the convenience of their threaded bonnets, the reliability of their double-beaded diaphragm and the durability of their heavy-duty, corrosion and UV-resistant PVC construction. Fast and easy to install and service, these 1-inch residential plastic valves offer an encapsulated solenoid, internal/external bleed, an optional flow control feature, and are available in multiple configurations.

## KEY FEATURES & BENEFITS

### THREADED BONNET DESIGN

Allows easy servicing without removal from the system

### RUGGED, DOUBLE-BEADED SANTOPRENE® DIAPHRAGM

Ensures a leak-proof seal

### INTERNAL AND EXTERNAL BLEED (FLUSH MODE)

Allows for manual operation

### FULL STAINLESS-STEEL METERING SYSTEM

Allows for consistent valve operation

### HEAVY-DUTY, CORROSION AND UV-RESISTANT PVC, GLASS-FILLED POLYPROPYLENE AND STAINLESS STEEL CONSTRUCTION

Durable, long-term performance

### AVAILABLE IN MULTIPLE CONFIGURATIONS—FEMALE NPT, SLIP, MALE X MALE AND MALE X BARB

Will handle all regional installation variances (2600 available with NPT threads only)

## VALVE SERVICING MADE EASY



## FRICTION LOSS DATA

MODEL	SIZE	Flow Rate - GPM						
		.25	2	5	10	15	20	30
2400 Series	1"	5.00	4.60	3.50	4.00	2.97	3.26	6.20
2600 Series	1"	5.00	4.60	3.34	2.15	1.78	1.90	3.85

1) Pressure loss data are derived from valves independently tested by CIT, Fresno, CA.  
 2) See friction loss charts on pages 98 through 115 for details.

## SPECIFYING INFORMATION

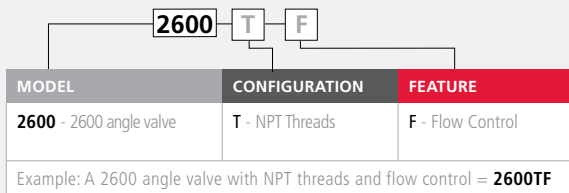
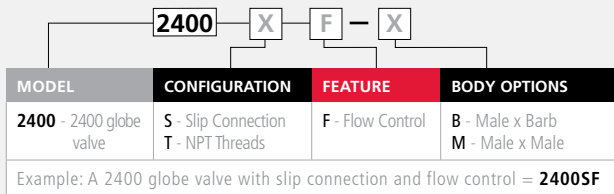

## ADDED FEATURES

- Buna-N valve seat seal
- Floating bleed tube allows thermal expansion without affecting performance
- Encapsulated injection-molded solenoid with a captive hex plunger
- Five-year warranty

## OPERATING SPECIFICATIONS

- Flow range: .25-30 GPM
- Pressure range: 10-150 psi

## ELECTRICAL SPECIFICATIONS

- Solenoid: 24 V ac
- Inrush volt-amp: 24 V ac-9.6 VA
- Inrush current: .4 amp
- Holding volt-amp: 24 V ac-4.8 VA
- Holding current: .2 amp

## MODELS

Model	Description
2400S	1" globe slip connection valve
2400SF	1" globe slip connection with flow control
2400T	1" globe NPT threaded connection
2400TF	1" globe NPT threaded connection with flow control
2400T-B	1" globe male x barb connection
2400TF-B	1" globe male x barb connection with flow control
2400T-M	1" globe male x male connection
2400TF-M	1" globe male x male connection with flow control
2600T	1" angle NPT threaded connection
2600TF	1" angle NPT threaded connection with flow control

## DIMENSIONS

- **2400:** H: 5 1/8", W: 3", L: 4"
- **2600:** H: 6 1/2", W: 3", L: 3 3/4"

## OPTIONAL ACCESSORIES\*

- Recycled-water solenoid kit (RW60-KIT); purple solenoid with purple warning tag
  - DC latching solenoid (DCL)
- Note: Maximum pressure for a valve that utilizes latching solenoid is 120 psi.*
- Threaded bonnet wrench (2400-45)



\* Optional accessories are field-installable.  
 Must specify separately if required.



## 1" PLASTIC MODELS

The Irritrol® 205 Series 1-inch plastic valve is the irrigation industry's time-tested leader for dependable operation in potable and dirty water applications. With a proven track record of success in a wide range of environments, these debris-tolerant valves are available with flow control as an optional feature. Constructed of heavy-duty, corrosion- and UV-resistant PVC, the 205 Series features a high-flow, low-friction-loss-design that has a pressure range of 10-150 psi and flow range of .25-30 GPM. A manual bleed and a rugged, nylon-reinforced Buna-N diaphragm add to this valve's wide popularity.

---

## KEY FEATURES & BENEFITS

### HEAVY-DUTY, CORROSION- AND UV-RESISTANT PVC CONSTRUCTION

Proven durability

### HIGH-FLOW, LOW FRICTION LOSS DESIGN

More efficient system design and low-flow capability

### RUGGED, NYLON-REINFORCED BUNA-N DIAPHRAGM

Ensures a leak-proof seal

### AVAILABLE IN FEMALE NPT OR SLIP CONFIGURATIONS (NO MALE PIPE ADAPTER REQUIRED)

Will handle all regional installation variances

### OPTIONAL FLOW CONTROL

Allows precise adjustment and manual shutoff



## OVER 40 YEARS OF DEPENDABILITY



A flat fiber washer diaphragm allows the 205 to work in a wide flow range as well as easily handle debris

## FRICTION LOSS DATA

MODEL	SIZE	Flow Rate - GPM						
		.25	2	5	10	15	20	30
205 Series	1"	5.40	3.82	3.00	2.20	1.90	3.10	5.10

1) Pressure loss data are derived from valves independently tested by CIT, Fresno, CA.  
 2) See friction loss charts on pages 98 through 115 for details.

## SPECIFYING INFORMATION

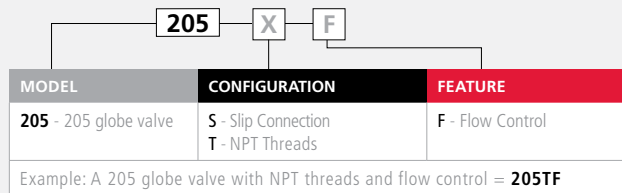

## ADDED FEATURES

- Buna-N valve seat seal
- Manual external bleed
- Debris-tolerant design
- Encapsulated injection-molded solenoid with a captive hex plunger
- Removable, tamper-resistant flow control handle
- Easily serviced without removal from the system
- Five-year warranty

## OPERATING SPECIFICATIONS

- Flow range: 0.25-30 GPM
- Pressure range: 10-150 psi

## ELECTRICAL SPECIFICATIONS

- Solenoid: 24 V ac
- Inrush volt-amp: 24 V ac-9.6 VA
- Inrush current: .4 amp
- Holding volt-amp: 24 V ac-4.8 VA
- Holding current: .2 amp

## MODELS

Model	Description
205S	1" slip connection
205SF	1" slip connection with flow control
205T	1" NPT threaded connection
205TF	1" NPT threaded connection with flow control

## DIMENSIONS

- H: 5 1/8", W: 2 3/4", L: 5"

## OPTIONAL ACCESSORIES\*

- Recycled-water solenoid kit (RW60-KIT); purple solenoid with purple warning tag
- DC latching solenoid (DCL)  
*Note: Maximum pressure for a valve that utilizes latching solenoid is 120 psi.*

\* Optional accessories are field-installable. Must specify separately if required.



## 3/4" AND 1" PLASTIC MODELS

The Irritrol® 2500 Series is a classic example of making a great valve even better. Irritrol has taken its proven 205 Series of valves to the next level by adding a full menu of features including a patented "floating metering system" for consistent performance in dirty water applications and a rugged, double-beaded diaphragm for long-term performance with no leakage. The 2500's manual internal bleed enables the valve to be opened without filling the valve box with water. And servicing is made easy and efficient with captured screws.

## KEY FEATURES & BENEFITS

### **PATENTED "FLOATING METERING SYSTEM"**

Allows this valve to easily handle dirty water

### **HIGH-FLOW, LOW FRICTION LOSS DESIGN COMBINED WITH LOW-FLOW CAPABILITY**

Can handle a wide range of applications

### **RUGGED, DOUBLE-BEADED SANTOPRENE® DIAPHRAGM**

Ensures a leak-proof seal

### **INTERNAL AND EXTERNAL BLEED (FLUSH MODE)**

Allows for manual operation

### **FULL STAINLESS-STEEL METERING SYSTEM**

Allows for consistent valve operation

### **HEAVY-DUTY, CORROSION AND UV-RESISTANT PVC AND STAINLESS STEEL CONSTRUCTION**

Proven durability

### **AVAILABLE IN FEMALE NPT OR SLIP CONFIGURATIONS (NO MALE PIPE ADAPTER REQUIRED)**

Will handle all regional installation variances

### **SELF-ALIGNING BONNET**

Permits fast and easy servicing without removal from the system

## IDEAL FOR DIRTY WATER APPLICATIONS



Debris-tolerant, patented "floating metering system" makes this valve ideal for wells and dirty water applications

## FRICTION LOSS DATA

Flow Rate - GPM

MODEL	SIZE	.25	2	5	10	15	20	30
2500 Series	1"	5.40	3.82	3.00	2.20	1.90	3.10	5.10
2507 Series	3/4"	2.75	3.40	3.85	4.00	2.40	3.98	6.19

1) Pressure loss data are derived from valves independently tested by CIT, Fresno, CA.  
2) See friction loss charts on pages 98 through 115 for details.

## SPECIFYING INFORMATION

2500 — X — F

MODEL	CONFIGURATION	FEATURE
2500 - 2500 globe valve	S - Slip Connection T - NPT Threads	F - Flow Control

Example: A 2500 globe valve with NPT threads and flow control = **2500TF**

2507 — T — F

MODEL	CONFIGURATION	FEATURE
2507 - 2507 globe valve	T - NPT Threads	F - Flow Control

Example: A 3/4" 2507 globe valve with NPT threads and flow control = **2507TF**

## ADDED FEATURES

- Buna-N valve seat seal
- Debris-tolerant design
- Optional flow control allows precise adjustment and manual shutoff
- Encapsulated injection-molded solenoid with a captive hex plunger
- Removable, tamper-resistant flow control handle
- Easily serviced without removal from the system
- Five-year warranty

## OPERATING SPECIFICATIONS

- Flow range: 0.25-30 GPM
- Pressure range: 10-150 psi

## ELECTRICAL SPECIFICATIONS

- Solenoid: 24 V ac
- Inrush volt-amp: 24 V ac-9.6 VA
- Inrush current: .4 amp
- Holding volt-amp: 24 V ac-4.8 VA
- Holding current: .2 amp

## MODELS

Model	Description
2500S	1" slip connection
2500SF	1" slip connection with flow control
2500T	1" NPT threaded connection
2500TF	1" NPT threaded connection with flow control
2507TF	3/4" NPT threaded connection with flow control

## DIMENSIONS

- **2500:** H: 5 1/8", W: 2 3/4", L: 5"
- **2507:** H: 5 1/8", W: 2 3/4", L: 5"

## OPTIONAL ACCESSORIES \*

- Recycled-water solenoid kit (RW60-KIT); purple solenoid with purple warning tag
- DC latching solenoid (DCL)  
*Note: Maximum pressure for a valve that utilizes latching solenoid is 120 psi.*

\* Optional accessories are field-installable.  
Must specify separately if required.

# 2700 SERIES

## ELECTRIC AND MANUAL ANTI-SIPHONS



### 3/4" AND 1" PLASTIC MODELS

The Irritrol® anti-siphon 2700 Series valves offer optimum performance, reliability and ease-of-use for a wide variety of residential applications. Featuring anti-siphon capability, this family of plastic valves also features flow control for precise flow adjustment, manual shutoff and a built-in atmospheric vacuum breaker to eliminate back siphonage. Available in electric and manual models, these valves also feature a flow range from .25 to 30 GPM and a pressure range from 10 to 150 psi.

## KEY FEATURES & BENEFITS

### **RUGGED, DOUBLE-BEADED SANTOPRENE® DIAPHRAGM**

Ensures a leak-proof seal

### **INTERNAL AND EXTERNAL BLEED (FLUSH MODE)**

Allows for manual operation

### **FULL STAINLESS-STEEL METERING SYSTEM (DPR MODELS)**

Consistent valve operation

### **PATENTED "FLOATING METERING SYSTEM" (APR MODELS)**

Consistent valve operation

### **HEAVY-DUTY, CORROSION- AND UV-RESISTANT PVC, GLASS-FILLED POLYPROPYLENE (DPR MODELS ONLY) AND STAINLESS STEEL CONSTRUCTION**

Durable, long-term performance

### **SELF-ALIGNING BONNET WITH CAPTURED HEX/PHILLIPS SCREWS**

Permits fast and easy servicing without removal from the system (APR models)

### **THREADED BONNET DESIGN**

Allows easy servicing without removal from the system (DPR models)

### **PATENTED, TAMPER-RESISTANT FLOW-CONTROL MECHANISM**

Allows for precise water flow (DPR models)

## DOUBLE-BEADED DIAPHRAGM



A double-beaded Santoprene® diaphragm gives you the security that your valve will continue to operate without leaks, time after time

## FRICTION LOSS DATA

MODEL	SIZE	Flow Rate - GPM				
		5	10	15	20	25
2706PR	¾"	1	3	5		
2709PR	1"	1	1	2	4	6

MODEL	SIZE	Flow Rate - GPM						
		.25	2	5	10	15	20	30
2711APR & DPR	¾"	5.0	5.8	4.14	4.11	4.72	7.60	
2713APR & DPR	1"	5.0	5.5	2.03	3.10	2.22	3.72	8.01

1) Pressure loss data are derived from valves independently tested by CIT, Fresno, CA.  
2) See friction loss charts on pages 98 through 115 for details.

## SPECIFYING INFORMATION

270 X PR

MODEL	SIZE	TYPE
270 - 2700 manual valve	6 - ¾" size 9 - 1" size	PR - anti-siphon

Example: A 2700 manual ¾", anti-siphon valve = **2706PR**

271 X X PR

MODEL	SIZE	OPTION	TYPE
271 - 2700 electric valve	1 - ¾" size 3 - 1" size	A - stainless screws D - threaded bonnet	PR - anti-siphon

Example: A 2700 electric 1" anti-siphon valve with stainless screws = **2713APR**

Note: Anti-siphon valve to be mounted above ground at least 6" above highest sprinkler head (consult local codes).

## ADDED FEATURES

- Buna-N valve seat seal
- Flow control for precise adjustment and manual shutoff
- Gravity-type anti-siphon poppet
- Encapsulated injection-molded solenoid with a captive hex plunger
- Removable, ergonomic, tamper-resistant flow-control handle (APR models)
- Electric H-body with atmospheric vacuum breaker
- Five-year warranty

## OPERATING SPECIFICATIONS

- Flow range: .25-30 GPM
- Pressure range: 10-150 psi

## ELECTRICAL SPECIFICATIONS

- Solenoid: 24 V ac
- Inrush volt-amp: 24 V ac-9.6 VA
- Inrush current: .4 amp
- Holding volt-amp: 24 V ac-4.8 VA
- Holding current: .2 amp
- Meets listing standards of ASSE, IAPMO and CSA

## MODELS

Model	Description
2711APR	¾" electric, flow control, stainless screw bonnet
2713APR	1" electric, flow control, stainless screw bonnet
2711DPR	¾" electric, flow control, threaded bonnet
2713DPR	1" electric, flow control, threaded bonnet
2706PR	¾" manual
2709PR	1" manual

## DIMENSIONS

- **2706:** H: 4 7/8", W: 2 5/8", L: 5 3/4"
- **2709:** H: 5 1/16", W: 3 1/8", L: 6 1/4"
- **2711:** H: 5 5/8", W: 3", L: 6 1/4"
- **2713:** H: 6", W: 3", L: 6 7/8"

## OPTIONAL ACCESSORIES\*

- Recycled-water solenoid kit (RW60-Kit); purple solenoid with purple warning tag
- DC latching solenoid (DCL)  
*Note: Maximum pressure for a valve that utilizes latching solenoid is 120 psi.*
- Threaded bonnet wrench (2400-45) for DPR models

\* Optional accessories are field-installable. Must specify separately if required.



# 311A SERIES

## ELECTRIC ANTI-SIPHON



### 3/4" AND 1" PLASTIC MODELS

The Irritrol® 311 Series offers a comprehensive package of performance-enhancing features. Beginning with the reliability of a leak-proof, double-beaded, nylon-reinforced Buna-N diaphragm, the strength of glass-filled nylon and the expanded range of a maximum working pressure rating of 150 psi, the 311 Series' list of features easily outdistances the competition. Compatibility with the OmniReg® modular pressure regulator make them the industry's only anti-siphon valves with a pressure regulation option. Additional features include an upgraded bonnet design, a self-cleaning metering system for dirty water applications and a captive plunger solenoid. Plus, the actuator module is removable as a single unit with the diaphragm and internal components held in place, which means no more lost diaphragm screws and springs during installation.

### KEY FEATURES & BENEFITS

#### UPPER BODY AND AIR-VENT CAP CONSTRUCTED OF GLASS-FILLED NYLON

Provides long-term performance

#### RUGGED, DOUBLE-BEADED NYLON-REINFORCED BUNA-N DIAPHRAGM

Ensures a leak-proof seal

#### INTERNAL AND EXTERNAL BLEED (FLUSH MODE)

Manual operation

#### ACCEPTS OMNIREG MODULAR PRESSURE REGULATOR

Ensures consistent performance

#### EXTERNALLY REMOVABLE SELF-CLEANING METERING SYSTEM

Ensures consistent performance in recycled-water applications

## PREMIER ANTI-SIPHON VALVES

An externally removable self-cleaning metering system makes this valve ideal for wells and dirty water



Bonnet made of glass-filled nylon for added durability

Built-in atmospheric vacuum breaker keeps drinking water safe

## FRICTION LOSS DATA

MODEL	SIZE	Flow Rate - GPM						
		1	5	10	15	20	25	30
311A-.75	¾"	5.5	6.0	8.0	9.0	11.0		
311A-1	1"	5.5	6.0	7.5	8.5	10.0	13.0	18.5

1) Pressure loss data are derived from valves independently tested by CIT, Fresno, CA.  
2) See friction loss charts on pages 98 through 115 for details.

## SPECIFYING INFORMATION

<b>311A</b> - <b>XX</b>	
MODEL	SIZE
<b>311A</b> - 311 electric anti-siphon valve	<b>.75</b> - ¾" size <b>1</b> - 1" size
Example: A 311 electric anti-siphon 1" valve = <b>311A-1</b>	

Note: Anti-siphon valve to be mounted above ground at least 6" above highest sprinkler head (consult local codes).

## ADDED FEATURES

- Flow control allows precise adjustment and manual shutoff
- Lower body constructed of heavy-duty, corrosion- and UV-resistant PVC
- Buna-N valve seat seal
- All stainless steel hardware and springs
- Unique three-way stainless steel bonnet screws with threaded-brass inserts
- Encapsulated injection-molded solenoid with a captive hex plunger
- Removable, tamper-resistant flow control handle
- Meets listing requirements of IAPMO-UPC and City of Los Angeles
- Five-year warranty

## OPERATING SPECIFICATIONS

- Flow range: 1-30 GPM
- Pressure range: 10-150 psi
- Operating temperature: up to 130° F

## ELECTRICAL SPECIFICATIONS

- Solenoid: 24 V ac
- Inrush volt-amp: 24 V ac-9.6 VA
- Inrush current: .4 amp
- Holding volt-amp: 24 V ac-4.8 VA
- Holding current: .2 amp

## MODELS

Model	Description
311A-.75	¾" flow control, internal bleed
311A-1	1" flow control, internal bleed

## DIMENSIONS

- **311A-.75**: H: 8 ½", W: 3 ⅝", L: 6"
- **311A-1**: H: 8 ½", W: 3 ⅝", L: 6"

## OPTIONAL ACCESSORIES\*

- OmniReg® 5-30 psi regulator (OMR-30)
- OmniReg 5-100 psi regulator (OMR-100)
- Recycled-water solenoid kit (RW60-KIT); purple solenoid with purple warning tag
- DC latching solenoid (DCL)  
*Note: Maximum pressure for a valve that utilizes latching solenoid is 120 psi.*
- Weatherproof gauge (SPK-100)

\* Optional accessories are field-installable.  
Must specify separately if required.

# 2623DPR | 300 SERIES

ELECTRIC VALVE ADAPTERS



## 3/4" AND 1" PLASTIC MODELS

These electric anti-siphon valve adapters feature outstanding durability for consistent, dependable performance in all types of applications. Plus, having all of the internal components captured in a single unit means converting manual valves to electric doesn't get any easier.

## KEY FEATURES & BENEFITS

### **2623DPR SERIES**

**CONVERTS CHAMPION® BRASS ANTI-SIPHON VALVES TO ELECTRIC OPERATION**

Automatic system function

**INTERNAL AND EXTERNAL BLEED (FLUSH MODE)**

Allows for manual operation

**RUGGED, DOUBLE-BEADED SANTOPRENE® DIAPHRAGM**

Provides a leak-proof seal

**HEAVY-DUTY, CORROSION- AND UV-RESISTANT PVC AND STAINLESS STEEL CONSTRUCTION**

For long-term reliability

### **300 SERIES**

**CONVERTS 3/4-INCH AND 1-INCH CHAMPION BRASS ANTI-SIPHON VALVES (MODELS 300-.75 AND 300-1) AND 1-INCH IRRITROL MANUAL VALVES TO ELECTRIC OPERATION**

Automatic system function

**INTERNAL AND EXTERNAL BLEED (FLUSH MODE)**

Allows for manual operation

**RUGGED, DOUBLE-BEADED NYLON-REINFORCED BUNA-N DIAPHRAGM**

Provides a leak-proof seal

**EXTERNALLY REMOVABLE SELF-CLEANING METERING SYSTEM**

Ensures consistent performance in recycled-water applications

**TOUGH, GLASS-REINFORCED NYLON, STAINLESS STEEL AND BRASS CONSTRUCTION**

Provides proven durability



## SINGLE PIECE ADAPTERS MAKE CONVERSIONS SIMPLE

Internal and external bleed for manual operation

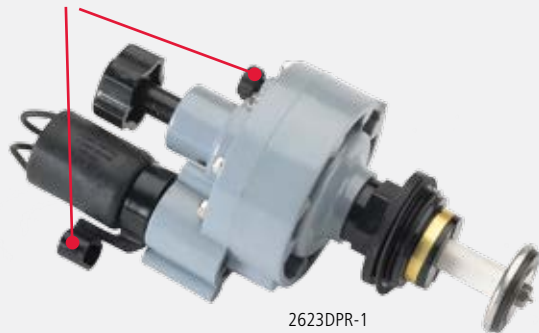

2623DPR-1

Externally removable self-cleaning metering system ensures consistent operation

Constructed of tough glass-filled nylon to handle system surges



300-.75

## SPECIFYING INFORMATION

**2623DPR** - **XX**

MODEL	SIZE
<b>2623DPR</b> - 2623DPR PVC valve adapter	.75 - 3/4" size 1 - 1" size

Example: A 2623DPR, 1" PVC valve adapter = **2623DPR-1**

**300** - **XX**

MODEL	SIZE
<b>300</b> - 300 glass-reinforced nylon valve adapter	.75 - 3/4" size 1 - 1" size

Example: A 300, 1" glass-reinforced nylon valve adapter = **300-1**

Note: Anti-siphon valve to be mounted above ground at least 6" above highest sprinkler head (consult local codes).

## ADDED FEATURES

- Ergonomic flow control allows precise flow adjustment and manual shutoff
- Buna-N valve seat seal
- Encapsulated injection-molded solenoid with a captive hex plunger
- Accepts OmniReg® modular pressure regulator
- Five-year warranty

### 2623DPR Series Only

- Slow-closing design
- Full stainless steel metering system
- Hex/Phillips screws
- Easy installation
- Compact design

### 300 Series Only

- Unique three-way stainless steel bonnet screws with threaded-brass inserts

## OPERATING SPECIFICATIONS

- Pressure range: 10-150 psi

## ELECTRICAL SPECIFICATIONS

- Solenoid: 24 V ac
- Inrush volt-amp: 24 V ac-9.6 VA
- Inrush current: .4 amp
- Holding volt-amp: 24 V ac-4.8 VA
- Holding current: .2 amp

## MODELS

Model	Description
2623DPR-.75	3/4" PVC valve adapter
2623DPR-1	1" PVC valve adapter
300-.75	3/4" glass-reinforced nylon valve adapter
300-1	1" glass-reinforced nylon valve adapter

## DIMENSIONS

- **2623DPR Series:** H: 6 3/4", W: 2 7/8"
- **300 Series:** H: 7 1/4", W: 4"

## OPTIONAL ACCESSORIES\*

- OmniReg 5-30 psi regulator (OMR-30)
- OmniReg 5-100 psi regulator (OMR-100)
- Recycled-water solenoid kit (RW60-KIT); purple solenoid with purple warning tag
- DC latching solenoid (DCL)  
*Note: Maximum pressure for a valve that utilizes latching solenoid is 120 psi.*
- Weatherproof gauge (SPK-100)

\* Optional accessories are field-installable. Must specify separately if required.

# 200B SERIES

## ELECTRIC GLOBE/ANGLE



### 1", 1½" AND 2" PLASTIC MODELS

The Irritrol® 200B Series globe/angle valves have built their popularity on a proven record of reliability and a reputation for offering valuable features at an affordable price. The 200B Series provides manual internal and external bleed, heavy-duty, UV-resistant PVC construction, stainless steel hardware, a double-beaded diaphragm and a captive solenoid plunger.

### KEY FEATURES & BENEFITS

**HEAVY-DUTY, CORROSION- AND UV-RESISTANT PVC CONSTRUCTION WITH STAINLESS STEEL SPRING AND HARDWARE**

Provides consistent operation

**SLOW-CLOSING DESIGN**

Reduces water hammer and resulting stress on the system

**RUGGED, DOUBLE-BEADED SANTOPRENE® DIAPHRAGM**

Ensures a leak-proof seal

**INTERNAL AND EXTERNAL BLEED (FLUSH MODE)**

Allows for manual operation

**ACCEPTS OMNIREG® MODULAR PRESSURE REGULATOR**

Ensures consistent performance

**HIGH-STRENGTH RIBBED BONNET AND BOTTOM INLET**

Increases durability

**UNIQUE THREE-WAY STAINLESS STEEL BONNET**

Screws accept Phillips, flat-blade and hex-driver tools for easy servicing without removal from the system

## DURABLE HEAVY-DUTY CONSTRUCTION

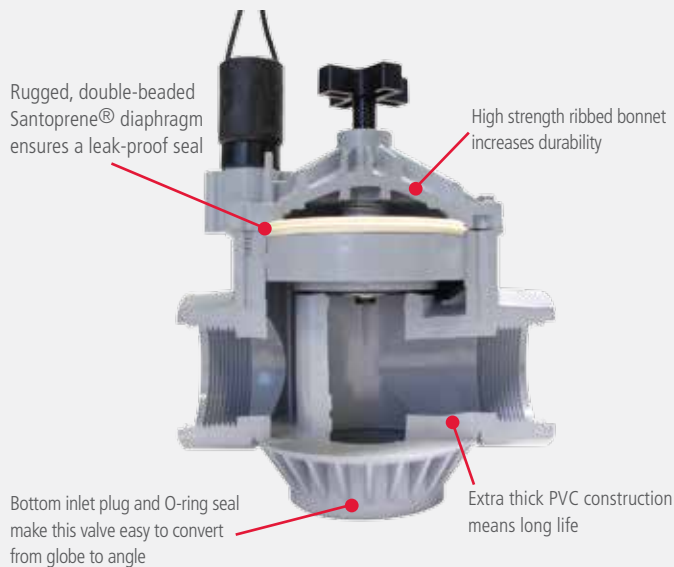

## FRICTION LOSS DATA

MODEL	SIZE	GLOBE ANGLE	Flow Rate - GPM													
			5	10	15	20	30	40	50	60	80	100	120			
214B	1"	G	3.36	2.60	1.82	2.35	5.40									
		A	3.09	2.20	1.48	1.98	4.00									
216B	1½"	G				3.04	2.66	2.33	2.97	4.14	5.62					
		A				2.76	2.24	1.99	2.30	3.10	4.42					
217B	2"	G				2.00	1.93	1.73	1.55	1.68	2.99	4.85	6.31			
		A				2.00	1.93	1.73	1.55	1.59	2.15	3.27	4.88			

1) Pressure loss data are derived from valves independently tested by CIT, Fresno, CA.  
 2) See friction loss charts on pages 98 through 115 for details.

## SPECIFYING INFORMATION

MODEL	SIZE
21 - 200B Series electric valve	4 - 1" size 6 - 1½" size 7 - 2" size
Example: A 200B Series 1" electric valve = <b>214B</b>	

## ADDED FEATURES

- Flow control allows precise adjustment and manual shutoff
- Buna-N valve seat seal
- Unique threaded inlet plug O-ring seal prevents leaks
- Encapsulated injection-molded solenoid with a captive hex plunger
- Five-year warranty

## OPERATING SPECIFICATIONS

- Flow range: 5-120 GPM
- Pressure range: 20-150 psi

## ELECTRICAL SPECIFICATIONS

- Solenoid: 24 V ac
- Inrush volt-amp: 24 V ac-9.6 VA
- Inrush current: .4 amp
- Holding volt-amp: 24 V ac-4.8 VA
- Holding current: .2 amp

## MODELS

Model	Description
214B	1" NPT threads, flow control
216B	1½" NPT threads, flow control
217B	2" NPT threads, flow control

## DIMENSIONS

- **214B:** H: 6 ½", W: 2 ½", L: 4 ½"
- **216B:** H: 7 ¾", W: 4 ¼", L: 5 ½"
- **217B:** H: 8 ¾", W: 5 ¾", L: 6 ¼"

## OPTIONAL ACCESSORIES\*

- OmniReg® 5-30 psi regulator (OMR-30)
- OmniReg 5-100 psi regulator (OMR-100)
- Recycled-water solenoid kit (RW60-KIT); purple solenoid with purple warning tag
- DC latching solenoid (DCL)  
*Note: Maximum pressure for a valve that utilizes latching solenoid is 120 psi.*
- Weatherproof gauge (SPK-100)

\* Optional accessories are field-installable.  
 Must specify separately if required.



## 3/4", 1", 1 1/2" AND 2" PLASTIC MODELS

Featuring a straight-through flow path that dramatically reduces pressure loss, the Irritrol® UltraFlow Series of plastic valves leads the industry in long-term performance and reliability. With a flow range from .1 to 180 GPM and a self-cleaning, 150-mesh stainless steel filter screen, these unique valves are ideal for a multitude of potable and dirty water applications. A glass-reinforced nylon body and bonnet, stainless steel spring and hardware, and a rugged, nylon-reinforced Buna-N diaphragm add an extra dimension of toughness to this very durable family of valves.

## KEY FEATURES & BENEFITS

### UNIQUE STRAIGHT-THROUGH FLOW PATH

Provides extremely low friction loss

### SLOW-CLOSING DESIGN

Reduces water hammer and resulting stress on the system

### TOUGH GLASS-REINFORCED NYLON, STAINLESS STEEL AND BRASS CONSTRUCTION

Provides durability and long life

### HIGH AND LOW-FLOW OPERATION

Ensures consistent performance in a variety of applications

### SELF-FLUSHING, 150-MESH, STAINLESS STEEL FILTER SCREEN ON 1-, 1 1/2- AND 2-INCH MODELS

Provides consistent operation

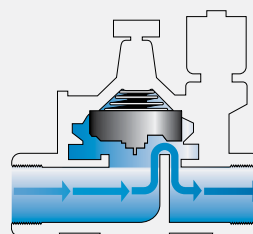

Conventional flow path

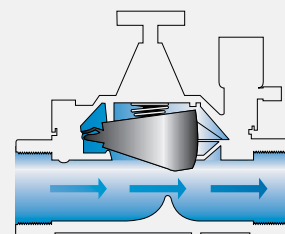

The UltraFlow Series straight-through flow path

## ULTRA-FLOW® TECHNOLOGY



Self-flushing, 150 mesh stainless steel filter screen provides consistent operation

Straight-through flow path provides a wide flow range with minimal friction loss

## FRICTION LOSS DATA

MODEL	SIZE	Flow Rate - GPM								
		0.1	2	5	10	15	20	30	40	50
700B-.75	¾"	0.38	0.38	0.86	1.22	2.03	3.27	6.75		
700-1	1"	2.20	1.59	1.80	2.41	2.23	1.84	3.22	5.58	8.59

MODEL	SIZE	Flow Rate - GPM											
		15	20	30	40	50	60	80	100	120	140	160	180
700-1.5	1½"	0.19	0.36	0.69	1.13	1.49	2.13	3.85	6.06	8.72	11.89		
700-2	2"			0.64	0.83	0.98	1.17	2.07	3.06	3.96	5.21	6.50	8.23

- 1) Pressure loss data are derived from valves independently tested by CIT, Fresno, CA.
- 2) See friction loss charts on pages 98 through 115 for details.

## SPECIFYING INFORMATION

700 - XXX	
MODEL	SIZE
700 - 700 UltraFlow electric valve	B-.75 - ¾" size 1 - 1" size 1.5 - 1½" size 2 - 2" size
Example: A 700 UltraFlow electric 1" valve = <b>700-1</b>	

## ADDED FEATURES

- Manual internal bleed
- Wide flow range
- Flow control allows precise flow adjustment and manual shutoff (not available on ¾-inch model)
- Compact, low-profile design
- Rugged nylon-reinforced Buna-N diaphragm provides leak-proof seal
- Buna-N valve seat seal
- Encapsulated injection-molded solenoid with a captive hex plunger
- Unique three-way stainless steel bonnet screws with threaded brass inserts accept Phillips, flat-blade and hex-driver tools
- Five-year warranty

## OPERATING SPECIFICATIONS

- Flow range: .1-180 GPM (700B-.75 & 700-1 can operate at .1 GPM)
- Pressure range: 10-150 psi (700-2 not recommended under 25 psi)

## ELECTRICAL SPECIFICATIONS

- Solenoid: 24 V ac
- Inrush volt-amp: 24 V ac-9.6 VA
- Inrush current: .4 amp
- Holding volt-amp: 24 V ac-4.8 VA
- Holding current: .2 amp

## MODELS

Model	Description
700B-.75	¾" internal bleed flow control
700-1	1" internal bleed flow control
700-1.5	1½" internal bleed flow control
700-2	2" internal bleed flow control

## DIMENSIONS

- **700B-.75:** H: 4 ½", W: 1 9/10", D: 3 2/5"
- **700-1:** H: 4 ½", W: 3", D: 4 3/5"
- **700-1.5:** H: 5 ½", W: 4 3/8", D: 6 ¼"
- **700-2:** H: 7", W: 5 ½", D: 8"

## OPTIONAL ACCESSORIES\*

- OmniReg® 5-30 psi regulator (OMR-30)
- OmniReg® 5-100 psi regulator (OMR-100)
- Recycled-water solenoid kit (RW60-KIT); purple solenoid with purple warning tag
- DC latching solenoid (DCL)  
*Note: Maximum pressure for a valve that utilizes latching solenoid is 120 psi.*
- Weatherproof gauge (SPK-100)

\* Optional accessories are field-installable. Must specify separately if required.

# 100 SERIES ELECTRIC GLOBE/ANGLE CENTURY PLUS & 102 ANTI-CONTAMINATION MODEL



## 1", 1 1/2", 2" AND 3" PLASTIC MODELS

The Irritrol® 100 Series (Century PLUS) is an excellent example of a good valve getting better. Tracing its origin to the highly popular Century Series, the 100 Series delivers reliable performance with a host of enhanced features. Offered in a globe/angle configuration with sizes ranging from one to three inches, the 100 Series features a pressure range of 10-220 psi, optional modular pressure regulation, stainless steel metering, internal and external bleed, a nylon-reinforced Buna-N double-beaded diaphragm and an anti-contamination design for dirty water applications (available on all 102 Models).

## KEY FEATURES & BENEFITS

### TOUGH, GLASS-REINFORCED NYLON, STAINLESS STEEL AND BRASS CONSTRUCTION

Withstands high temperatures and system surges under pressure for long-term reliability

### 220 PSI PRESSURE RATING

Prevents water hammer and system damage in high-pressure installations

### INTERNAL AND EXTERNAL BLEED (FLUSH MODE)

Manual operation

### EXTERNALLY REMOVABLE SELF-CLEANING METERING SYSTEM

Provides consistent performance in recycled-water applications

### ACCEPTS OMNIREG® MODULAR PRESSURE REGULATOR

Ensures consistent performance

### 102 ANTI-CONTAMINATION MODELS\*

### 150-MESH EXTERNAL CONTROL WATER FILTER AND THREE-WAY SOLENOID

Provides non-continuous metering for recycled water applications

### SELECTABLE NORMALLY OPEN OR NORMALLY CLOSED MODE (FACTORY SET AT NORMALLY CLOSED)

Provides flexibility (102 only)

### CONTROL WATER FILTER

Allows easy external service

\*Not compatible with IBOC®300-9V, OmniReg and DC Latching Solenoid



102P1

## TOUGHEST UNDER PRESSURE

Self-cleaning/easy maintenance, each cycle cleans internal orifices. All parts are easily accessible without removing the valve from the system

Stainless steel springs and hardware assure long life under the most adverse conditions



Internally molded studs provide positive bonnet attachment

Nylon reinforced Buna-N diaphragm provides a leak-proof seal

## FRICTION LOSS DATA

MODEL	SIZE	GLOBE ANGLE	Flow Rate - GPM					
			5	10	20	30	40	50
100P1	1"	G	6.30	4.20	3.20	4.10	7.20	10.90
102P1		A	6.30	4.20	3.10	2.70	4.80	7.90

MODEL	SIZE	GLOBE ANGLE	Flow Rate - GPM								
			30	40	50	60	70	80	90	100	110
100P1.5	1½"	G	1.60	2.30	3.60	5.20	7.00	9.20	11.70	14.40	17.50
102P1.5		A	1.30	1.60	2.80	4.00	5.50	7.10	9.00	11.00	13.30

MODEL	SIZE	GLOBE ANGLE	Flow Rate - GPM								
			80	90	100	110	120	130	140	150	175
100P2	2"	G	2.10	2.70	3.30	4.00	4.80	5.60	6.50	7.50	8.60
102P2		A	1.20	1.60	2.00	2.40	2.80	3.30	3.90	4.40	5.00

MODEL	SIZE	GLOBE ANGLE	Flow Rate - GPM						
			150	175	200	225	250	275	300
100P3/ 102P3	3"	G	2.50	3.00	4.10	5.30	6.70	8.30	10.10
		A	1.90	2.40	3.30	4.30	5.50	6.90	8.50

1) Pressure loss data are derived from valves independently tested by CIT, Fresno, CA.  
2) See friction loss charts on pages 98 through 115 for details.

## SPECIFYING INFORMATION

MODEL	SIZE
<b>100P</b> - 100 internal bleed and flow control valve	1 - 1" size 1.5 - 1½" size
<b>102P</b> - 102 anti-contamination filter valve	2 - 2" size 3 - 3" size

Example: A 100P 1" valve with internal bleed and flow control = **100P1**

## ADDED FEATURES

- Flow control allows precise flow adjustment and manual shutoff
- Buna-N valve seat seal
- Encapsulated injection-molded solenoid with a captive hex plunger
- Positive O-ring seal on inlet plug prevents leaks without damaging seal threads
- Molded-in and anchored studs allow positive bonnet attachment and removal
- Brass flow control stem on 2- and 3-inch models
- Easily serviced without removal from the system
- Five-year warranty

## OPERATING SPECIFICATIONS

- Flow range: 5-300 GPM
- Pressure range: 10-220 psi; 10-100 psi (102 models)

## ELECTRICAL SPECIFICATIONS

- Solenoid: 24 V ac
- Inrush volt-amp: 24 V ac-9.6 VA
- Inrush current: .4 amp (102 models: .48 amp)
- Holding volt-amp: 24 V ac-4.8 VA
- Holding current: .2 amp (102 models: .24 amp)

## MODELS

Model	Description
100P1	1" internal bleed, flow control
100P1.5	1½" internal bleed, flow control
100P2	2" internal bleed, flow control
100P3	3" internal bleed, flow control
102P1	1" anti-contamination filter
102P1.5	1½" anti-contamination filter
102P2	2" anti-contamination filter
102P3	3" anti-contamination filter

## DIMENSIONS

- **100P1:** H: 6 ¾", W: 3 ⅝", D: 4 ¾"
- **102P1:** H: 7 ½", W: 5", D: 4 ¾"
- **100P1.5:** H: 7 ¼", W: 3 ⅝", D: 4 ¾"
- **102P1.5:** H: 7 ½", W: 5", D: 4 ¾"
- **100P2:** H: 9 ½", W: 6 ⅛", D: 7 ¾"
- **102P2:** H: 10 ¼", W: 7 ½", D: 7 ¾"
- **100P3:** H: 10 ¾", W: 6 ⅛", D: 8 ¼"
- **102P3:** H: 11 ½", W: 7 ½", D: 8 ½"

## OPTIONAL ACCESSORIES\*

- OmniReg® 5-30 psi regulator (OMR-30)
- OmniReg 5-100 psi regulator (OMR-100)
- Recycled-water solenoid kit (RW60-KIT); purple solenoid with purple warning tag
- DC latching solenoid (DCL)  
*Note: Maximum pressure for a valve that utilizes latching solenoid is 120 psi.*
- Weatherproof gauge (SPK-100)

\* Optional accessories are field-installable. Must specify separately if required.

# 100-S SERIES

## ELECTRIC GLOBE/ANGLE

### CENTURY PLUS SCRUBBER VALVE



## 2" AND 3" PLASTIC MODELS

Constructed of heavy-duty, glass-reinforced nylon, high grade stainless steel, brass and EPDM rubber materials, the 100 Series scrubber valves resist clogging and feature a patent-pending continuous scrubbing mechanism to actively fight dirt, algae and other particles from disrupting the functionality of the valve. The 100 Series scrubber valves are true dirty water irrigation valves, able to handle the harsh chemicals found in dirty water systems, such as chlorines, chloramines and water treated with ozones.

## KEY FEATURES & BENEFITS

### CONTINUOUS SCRUBBING FEATURE

Actively cleans the metering device for consistent valve operation

### TOUGH, GLASS-REINFORCED NYLON, STAINLESS STEEL AND BRASS CONSTRUCTION

Withstands high temperatures and system surges under pressure for long-term reliability

### FABRIC-REINFORCED EPDM DIAPHRAGM AND EPDM SEAT SEAL

Designed to operate in virtually all water applications

### RUGGED INTERNAL PLASTIC AND STAINLESS STEEL PARTS

Scrubber fan, nut and metering system chlorine and chemical resistant

### COMPLETELY SERVICEABLE AND RETROFITTABLE

Diaphragm assembly may be replaced or retrofitted to previous models

### 220 PSI PRESSURE RATING

Prevents water hammer and system damage in high-pressure installations

### INTERNAL AND EXTERNAL BLEED (FLUSH MODE)

Manual operation

### EXTERNALLY REMOVABLE SELF-CLEANING METERING SYSTEM

Provides consistent performance in recycled-water applications

### ACCEPTS OMNIREG® MODULAR PRESSURE REGULATOR

Ensures consistent performance



## NEXT GENERATION SCRUBBER VALVE

Self-cleaning/easy maintenance, each cycle cleans internal orifices. All parts are easily accessible without removing the valve from the system

Fabric-reinforced EPDM diaphragm and EPDM seat designed to handle the harshest chemicals found in dirty water systems.

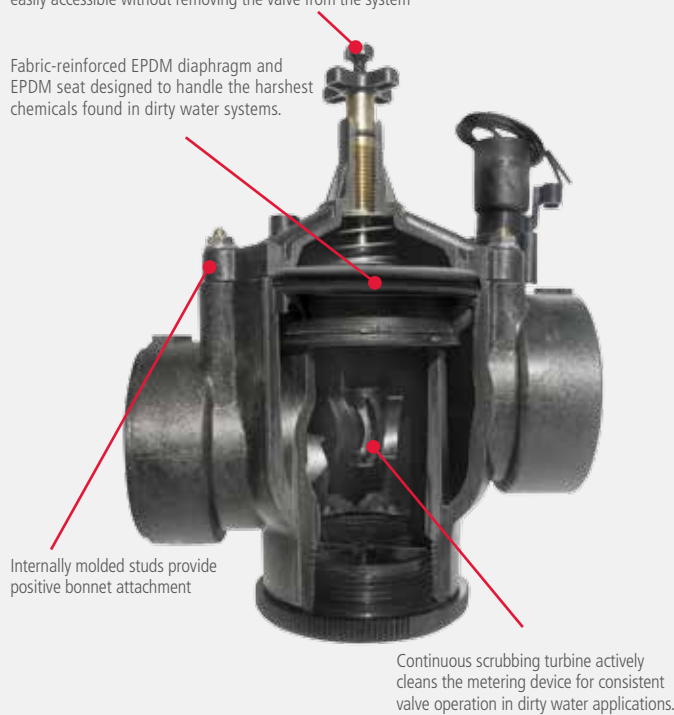

## FRICTION LOSS DATA

MODEL	SIZE	GLOBE ANGLE	Flow Rate - GPM									
			80	90	100	110	120	130	140	150	175	
100P2-S	2"	A	2.80	3.80	4.50	5.50	6.30	7.60	8.70	10.30	13.10	
		G	3.54	4.45	5.40	6.68	8.04	9.26	10.95	12.21	15.65	

MODEL	SIZE	GLOBE ANGLE	Flow Rate - GPM						
			150	175	200	225	250	275	300
100P3-S	3"	A	2.55	3.10	4.50	5.40	7.10	8.40	10.15
		G	2.97	4.04	5.37	6.35	7.99	9.35	11.26

1) See friction loss charts on pages 98 through 115 for details.

## SPECIFYING INFORMATION

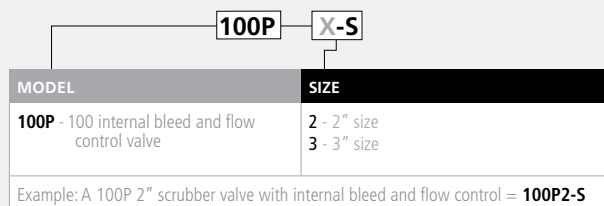

## ADDED FEATURES

- Flow control allows precise flow adjustment and manual shutoff
- EPDM valve seat seal
- Encapsulated injection-molded solenoid with a captive hex plunger
- Positive O-ring seal on inlet plug prevents leaks without damaging seal threads
- Molded-in and anchored studs allow positive bonnet attachment and removal
- Brass flow control stem
- Easily serviced without removal from the system
- Five-year warranty

## OPERATING SPECIFICATIONS

- Flow range: 5-300 GPM
- Pressure range: 10-220 psi (minimum pressure 20 psi)

## ELECTRICAL SPECIFICATIONS

- Solenoid: 24 V ac
- Inrush volt-amp: 24 V ac-9.6 VA
- Inrush current: .4 amp
- Holding volt-amp: 24 V ac-4.8 VA
- Holding current: .2 amp

## MODELS

Model	Description
100P2-S	2" internal bleed, scrubber valve
100P3-S	3" internal bleed, scrubber valve
100P2-S-KIT	2" scrubber diaphragm kit
100P3-S-KIT	3" scrubber diaphragm kit

## DIMENSIONS

- **100P2-S:** H: 9 1/2", W: 6 1/8", D: 7 3/4"
- **100P3-S:** H: 10 3/4", W: 6 1/8", D: 8 1/4"

## OPTIONAL ACCESSORIES\*

- OmniReg® 5-30 psi regulator (OMR-30)
- OmniReg 5-100 psi regulator (OMR-100)
- Recycled-water solenoid kit (RW60-KIT); purple solenoid with purple warning tag
- DC latching solenoid (DCL)  
*Note: Maximum pressure for a valve that utilizes latching solenoid is 120 psi.*
- Weatherproof gauge (SPK-100)

\* Optional accessories are field-installable. Must specify separately if required.

# DRIP ZONE VALVE KITS

ELECTRIC



## 3/4" AND 1" WITH OR WITHOUT AVB

Not all drip zone kits are created equal, and with Irritrol® drip zone kits, you'll know why. Featuring the industry's most recognized valves that have long been a standard for more than 40 years, these all-inclusive kits come complete with all the necessary components you need for a drip zone. Coupled with the added reliability of the industry's most popular valves, these kits include a Y-filter, pressure regulator and all the essential fittings to make a complete drip zone.

## KEY FEATURES & BENEFITS

### COMPLETE WITH IRRITROL CONTROL VALVE

Over 40 years of industry-recognized dependability

### IRRITROL Y-FILTER WITH A 150 MESH STAINLESS STEEL FILTER SCREEN

Proven performance for worry-free operation

### PRESSURE REGULATOR

Provides consistent outlet pressure levels suitable for drip irrigation

### AVAILABLE IN 11 VALVE CONFIGURATIONS IN 3/4" AND 1"

Multiple configurations to handle all installation variances

### ALSO AVAILABLE IN "LESS VALVE" CONFIGURATIONS

Allows for installation versatility



## FRICITION LOSS DATA

Flow Rate - GPM

MODEL	GPM (Flow)	0.25	5	8	15	20
2711APRDK-LF	Friction loss (psi)	3	5	5	n/a	n/a
	Min. Inlet (psi)	30	32	32	34	39
2711APRDK-MF	Friction loss (psi)	3	5	5	7	13
	Min. Inlet (psi)	30	32	32	34	39
2713APRDK-LF	Friction loss (psi)	3	5	5	n/a	n/a
	Min. Inlet (psi)	30	32	32	34	39
2713APRDK-MF	Friction loss (psi)	3	5	5	5	8
	Min. Inlet (psi)	30	32	32	32	35
2500DK-1-LF	Friction loss (psi)	3	3	3	n/a	n/a
	Min. Inlet (psi)	30	30	30	32	34
2500DK-1-MF	Friction loss (psi)	3	3	3	4.5	7
	Min. Inlet (psi)	30	30	30	32	34
2507DK-LF	Friction loss (psi)	3	5	5	n/a	n/a
	Min. Inlet (psi)	30	32	32	34	39
2507DK-MF	Friction loss (psi)	3	5	5	7	13
	Min. Inlet (psi)	30	32	32	34	39
700DK-1-LF	Friction loss (psi)	3	3	3	n/a	n/a
	Min. Inlet (psi)	30	30	30	32	34
700DK-1-MF	Friction loss (psi)	3	3	3	4.5	7
	Min. Inlet (psi)	30	30	30	32	34
700DK-075-LF	Friction loss (psi)	3	3	3	n/a	n/a
	Min. Inlet (psi)	30	30	30	32	34

## SPECIFYING INFORMATION

XXXXXXXX - DK - XXX - XX

MODEL	KIT	VALVE SIZE	FLOW RATE
700 - 700 Series Valve	DK - Drip Zone Kit	1 - 1"	LF - Low Flow
2500 - 2500 Series Valve		075 - 3/4"	MF - Medium Flow
2507 - 2507 Series Valve			
2711APR - 2711 Series Valve			
2713APR - 2713 Series Valve			

Example: A drip zone kit with a 700 Series UltraFlow, 1" commercial valve (0.1-8 gpm) = **700DK-1-LF**

DK - LV - XX

MODEL	LESS VALVE	FLOW RATE
DK - Drip Zone Kit	LV - Less Valve	LF - Low Flow MF - Medium Flow

## ELECTRICAL SPECIFICATIONS

- Solenoid: 24 V ac
- Inrush volt-amp: 24 V ac-9.6 VA
- Inrush current: .4 amp
- Holding volt-amp: 24 V ac-4.8 VA
- Holding current: .2 amp

## MODELS

Model	Description
700DK-1-LF	1" 700 UltraFlow Inline Valve, Filter, Low Flow Regulator & Fittings
700DK-1-MF	1" 700 UltraFlow Inline Valve, Filter, Medium Flow Regulator & Fittings
700DK-075-LF	3/4" 700 UltraFlow Inline Valve, Filter, Low Flow Regulator & Fittings
2500DK-1-LF	1" 2500 Valve, Filter, Low Flow Regulator & Fittings
2500DK-1-MF	1" 2500 Valve, Filter, Medium Flow Regulator & Fittings
2507DK-LF	3/4" 2507 Valve, Filter, Low Flow Regulator and Fittings
2507DK-MF	3/4" 2507 Valve, Filter, Medium Flow Regulator and Fittings
2711APRDK-LF	3/4" 2711APR Valve, AVB, Filter, Low Flow Regulator & Fittings
2711APRDK-MF	3/4" 2711APR Valve, AVB, Filter, Medium Flow Regulator & Fittings
2713APRDK-LF	1" 2713APR Valve, AVB, Filter, Low Flow Regulator & Fittings
2713APRDK-MF	1" 2713APR Valve, AVB, Filter, Medium Flow Regulator & Fittings
DK-LV-LF	Low Flow Regulator & Fittings
DK-LV-MF	Medium Flow Regulator & Fittings

## OPTIONAL ACCESSORIES\*

- Recycled-water solenoid kit (RW60-KIT); purple solenoid with purple warning tag
- DC latching solenoid (DCL)  
*Note: Maximum pressure for a valve that utilizes latching solenoid is 120 psi.*
- Weatherproof gauge (SPK-100)

\* Optional accessories are field-installable. Must specify separately if required.

MODEL	2711APRDK-LF	2711APRDK-MF	2713APRDK-LF	2713APRDK-MF	2500DK-1-LF	2500DK-1-MF	2507DK-LF	2507DK-MF	700DK-1-LF	700DK-1-MF	700DK-075-LF
Connection Size	3/4"	3/4"	1"	1"	1"	1"	3/4"	3/4"	1"	1"	3/4"
Control Valve Solenoid	24V ac, Inrush: 0.4 amps, 11.5 V a, Holding 0.20 amps, 5.75 V a										
Minimum Flow Rate	0.25 GPM	2 GPM	0.25 GPM	2 GPM	0.1 GPM	2 GPM	0.25 GPM	2 GPM	0.1 GPM	2 GPM	0.25 GPM
Maximum Flow Rate	8 GPM	20 GPM	8 GPM	20 GPM	8 GPM	20 GPM	8 GPM	20 GPM	8 GPM	20 GPM	8 GPM
Maximum Pressure	150 psi	150 psi	150 psi	150 psi	150 psi	150 psi	150 psi	150 psi	150 psi	150 psi	150 psi
Y-Filter Degree of Filtration	150 mesh	150 mesh	150 mesh	150 mesh	150 mesh	150 mesh	150 mesh	150 mesh	150 mesh	150 mesh	150 mesh
Regulator-Preset Pressure	25 psi	25 psi	25 psi	25 psi	25 psi	25 psi	25 psi	25 psi	25 psi	25 psi	25 psi
Thread Connection-Upstream	Female NPT	Female NPT	Female NPT	Female NPT	Female NPT	Female NPT	Female NPT	Female NPT	Female NPT	Female NPT	Female NPT
Thread Connection-Downstream	Female NPT	Female NPT	Male NPT	Female NPT	Male NPT	Female NPT	Female NPT	Female NPT	Male NPT	Female NPT	Female NPT
Minimum Number of Emitters:											
0.5 GPH	30	240	30	240	12	240	30	240	12	240	30
1 GPH	15	120	15	120	6	120	15	120	6	120	15
2 GPH	8	60	8	60	3	60	8	60	3	60	8
Maximum Number of Emitters:											
0.5 GPH	960	2400	960	2400	960	2400	960	2400	960	2400	960
1 GPH	490	1200	490	1200	490	1200	490	1200	490	1200	490
2 GPH	240	600	240	600	240	600	240	600	240	600	240

Note: Consult your local plumbing code for backflow prevention requirements.

\* AVB = Atmospheric Vacuum Breaker (Anti-siphon Valve)

# OMNIREG®

MODULAR PRESSURE REGULATOR



OMR-100

This pressure-regulating device enables the user to quickly and accurately set the exact downstream pressure required for any application.

## KEY FEATURES & BENEFITS

### MAINTAINS CONSTANT DOWNSTREAM PRESSURE, REGARDLESS OF WIDELY VARYING INLET PRESSURE

For consistent operation of heads

### ONE MODEL FITS ALL HEAVY-DUTY COMMERCIAL 100 SERIES (CENTURY PLUS), 700 SERIES (ULTRAFLOW®), 200B AND 311A SERIES VALVES\*

Streamlines inventory requirements

### REQUIRES ONLY 1 GPM TO OPERATE

Ideal for low-flow applications

### "DROP IN" INSTALLATION IS FAST AND EASY, REQUIRING TIGHTENING OF ONLY TWO CAPTURE SCREWS

For reduced labor time

\* Compatible with Century PLUS (excluding anti-contamination models), 700 UltraFlow® (1", 1½" and 2") and 311A manufactured after 1/1/96; 700 UltraFlow (¾") manufactured after 5/4/96; and 200B manufactured after 12/1/98.

## EASILY KEEP DOWNSTREAM PRESSURE CONSTANT



Simply turn the dial to the desired pressure

## ADDED FEATURES

- Clearly marked dial settings permit precise control of downstream pressure
- Desired pressure may be set with water on or off
- Delivers an accuracy of  $\pm 3$  psi
- Low-profile design permits use in applications with limited space
- Schrader valve test port is easily accessible for in-line use
- Manufactured of heavy-duty, corrosion-resistant glass-filled nylon
- Easily serviced internal module
- Stainless steel and brass hardware
- Vandal cap to avoid unauthorized use
- Five-year warranty

## OPERATING SPECIFICATIONS

- Flow range: 1 to 300 GPM
- Inlet pressure range: Up to 200 psi
- Pressure regulation:  
OMR-30: 5 to 30 psi, OMR-100: 5 to 100 psi
- Inlet pressure to be 10 psi greater than outlet pressure

## MODELS

Model	Description
OMR-30	Modular regulator 5-30 psi
OMR-100	Modular regulator 5-100 psi
OMR-DS	Downstream sensing kit

## SPECIFYING INFORMATION

MODEL	DESCRIPTION
OMR - Modular regulator	30 - 5-30 psi 100 - 5-100 psi DS - Downstream sensing kit**

Example: A regulator to regulate from 5-30 psi = **OMR-30**

\*\* This accessory may be used with either the OMR-30 or OMR-100 model to sense downstream pressure

# ACCESSORIES



**R811-24VACG**

- Captive hex plunger feature
- 24 V ac, .40 amp inrush, .20 amp holding



**RW60-KIT**

- Purple solenoid with purple warning tag
- Captive hex plunger feature
- 24 V ac, .40 amp inrush, .20 amp holding



**DCL SOLENOID**

DC latching solenoid for Hardie®, Richdel® and Irritrol® valves used with IBOC® and IBOC® Plus Series controllers



**SPK-100**

100 psi weatherproof gauge (fits OmniReg® and all Hardie® and Richdel® pressure regulators)



**SPK-HR1**

Prepackaged repair kit includes diaphragm assembly, O-ring, metering rod and fasteners (bulk 24 per)



**R205KIT**

Prepackaged repair kit for 205 Series non-flow control valves. Includes diaphragm assembly, bonnet assembly, fasteners and spring



**R205TFKIT**

Prepackaged repair kit for 205 Series flow control valves. Includes diaphragm assembly, bonnet assembly, fasteners and spring



**2400-45**

Threaded nut-ring wrench speeds assembly and service of 2400, 2600, 2711DPR and 2713DPR valves



**SPK-700-X**

Prepackaged repair kit for UltraFlow® Series valves includes diaphragm assembly, support ring, seat seal, O-rings and fasteners (bulk 24 per; repair instructions and parts breakdown included)



**SPK-100-X**

Prepackaged repair kit for Century Series valves includes diaphragm assembly, O-ring, metering rod and fasteners (bulk 24 per; repair instructions and parts breakdown included)



**R100PX**

Prepackaged repair kit for Century PLUS Series valves includes diaphragm assembly, O-rings, metering rod and fastening nuts (bulk 24 per; repair instructions and parts breakdown included)



**100P-S-KIT**

100 (Century) Series Scrubber valve diaphragm assembly kit. Complete with scrubbing turbine, EPDM diaphragm, EPDM seat seal and 316SS filter. Available in 2" and 3", fully assembled and ready to drop in a Century Series valve.

SPK-700X - XX	
MODEL	SIZE
SPK-700B	0.75"
SPK-700	1"
SPK-700	1.5"
SPK-700	2"

SPK-100 - XX	
MODEL	SIZE
SPK-100	1"
SPK-100	1.5"
SPK-100	2"
SPK-100	3"

R100P - XX	
MODEL	SIZE
R100P	1"
R100P	1.5"
R100P	2"
R100P	3"

100P - X - S-KIT	
MODEL	SIZE
100P	2"
100P	3"

# ROTORS

With taller pop-up heights and automatic arc return, Irritrol® rotors stand tall in the yard and in the industry. Add to that, easy installation and adjustment features and you can see why durable Irritrol rotors are rapidly becoming the contractor's choice.

# AT-A-GLANCE



**430R**

**TITAN**

**550R**

**PLATINUM SPORT**

pgs 70

pgs 71

pgs 72-73

pgs 74-75

## APPLICATION

TURF



SHRUBS/  
GROUND COVER



SLOPES



RUBBER COVER FOR  
ATHLETIC FIELDS



FULL/PART CIRCLE  
IN ONE SPRINKLER



RADIUS

20' – 35'

32' – 45'

25' – 50'

46' – 75'

INLET SIZE

1/2"

1/2" or 3/4"

3/4"

1"

PRESSURE RATING

30 – 50 psi

30 – 50 psi

25 – 65 psi

40 – 100 psi

STAINLESS STEEL  
RISER



CHECK VALVE



RECYCLED  
WATER OPTION



SHRUB



HIGH POP



AUTOMATIC  
RETURN



POP-UP HEIGHT

4"

3"

5"

5"

WARRANTY

2 Years

2 Years

5 Years

5 Years

## FEATURES

# 430R SERIES POP-UP ROTOR



## 1/2" GEAR-DRIVEN ROTOR

Rapidly becoming a contractor favorite, the 430R rotor from Irritrol® offers everything you would expect from a 1/2" rotor. When your application calls for more than ordinary spray heads, but not enough for large rotors, we offer the 430R. With a familiar arc setting and the ability to quick check the left and right stops, the 430R is sure to save time on installation.

## KEY FEATURES & BENEFITS

### FAMILIAR TOP ADJUSTMENT, WET OR DRY

For fast convenient installation

### REVERSING FULL- AND PART-CIRCLE OPERATION

Allows you to adjust the rotor from 40° to 360°

### PRESSURE-ACTIVATED WIPER SEAL

Reduces flow-by at pop-up and eliminates leaking. Ideal for low flow applications

### WIDE SELECTION OF NOZZLES

5 interchangeable nozzles to cover varying flow requirements

### POSITIVE LEFT AND RIGHT STOPS (FIXED RIGHT STOP)

Reduces set-up time by allowing you to quick check the arc

### STAINLESS STEEL ADJUSTMENT SCREW

Allows up to 25% radius reduction

### RATCHETING RISER

For easy arc adjustment



#### NO SPECIAL TOOLS REQUIRED

All arc adjustments made from the top with a standard screwdriver reduces set up time



Nozzle tree



Tool

## OPERATING SPECIFICATIONS

- Inlet: 1/2" female-threaded NPT
- Adjustable arc range: 40° to 360°
- Flow range: .8 – 3.4 GPM
- Recommended operating pressure: 30 – 50 psi
- Maximum operating pressure: 60 psi
- Overall height (retracted): 6"
- Radius: 20' to 35'
- Standard nozzle trajectory: 25°
- 5 interchangeable nozzles
- Riser height: 4"
- Two-year warranty

## MODELS

Model	Description
430R	1/2" inlet with 4" pop-up

## PERFORMANCE DATA

Nozzle	Pressure psi	Radius ft.	Flow GPM	Precip. ■ in/h	Precip. ▲ in/h
0.75	30	20	0.80	0.39	0.44
	40	21	0.90	0.39	0.45
	50	22	1.00	0.40	0.46
1.0	30	26	1.00	0.28	0.33
	40	27	1.10	0.29	0.34
	50	28	1.30	0.32	0.37
1.5	30	29	1.30	0.30	0.34
	40	30	1.50	0.32	0.37
	50	31	1.70	0.34	0.39
2.0	30	30	1.70	0.36	0.42
	40	31	2.00	0.40	0.46
	50	31	2.30	0.46	0.53
3.0	30	34	2.60	0.43	0.50
	40	35	3.00	0.47	0.54
	50	35	3.40	0.53	0.65

1. Precipitation rates based on half-circle operation
2. ■ square spacing based on 50% diameter of throw
3. ▲ triangular spacing based on 50% diameter of throw

Note: Data collected in zero wind conditions

## SPECIFYING INFORMATION

430R	
MODEL	INLET
430R - Gear-driven rotor	1/2" Female Threaded NPT
Example: 430R rotor, 1/2" female threaded, 4" height = <b>430R</b>	





## COMBINATION 1/2" OR 3/4" IMPACT ROTOR

Heavy-duty construction combined with a host of convenient features makes this rotor ideal for a broad range of residential and light commercial applications.

## KEY FEATURES & BENEFITS

### DOUBLE-WEIGHTED SPRAY GUIDE ARM

Controls stream and prevents side splash onto buildings and walkways

### 5 INTERCHANGEABLE, COLOR-CODED MPR NOZZLES

Pre-installed with black 3.0 gpm nozzle (no tools needed to change nozzles)

### HEAVY-DUTY, HIGH IMPACT CASE

With sturdy, reinforced ribbed design

### PRESSURE-ACTIVATED WIPER SEAL

Assures reliable pop-up and pop-down

### RADIUS REDUCTION SCREW

Allows for up to 25% in-field radius reduction

### UNIQUE LIP CASE DESIGN

Aids in setting proper installation height, prevents grass and weeds from growing into head and minimizes backwash

### REPLACES COMPETITIVE SPRINKLERS

Simple upgrade for other impacts, including Rain Bird® Maxi-Paw®

### STRAIGHT FLOW-THROUGH PATH

Ensures low pressure loss and positive action—even in very dirty water conditions

## OPERATING SPECIFICATIONS

- Filter screen to prevent clogging
- Removable cap for easy servicing and debris removal
- Full- and part-circle adjustable from 20° to 360°
- Radius: 32' - 45'
- Flow rate: 1.50–7.50 GPM
- Recommended operating pressure range: 30–50 psi
- Maximum operating pressure: 60 psi
- Recommended spacing: 22' to 45'
- Trajectory: 18°
- Pop-up to nozzle: 3"
- Combination 1/2" or 3/4" female-threaded inlet
- Dimensions:
  - Body diameter: 2 1/2"–5"
  - Cap diameter: 5"
  - Height: 9 3/10"
- Two-year warranty

## MODELS

Model	Description
430R	1/2" inlet with 4" pop-up

## TITAN ROTOR - Standard Nozzle

Nozzle	Pressure psi	Radius ft.	Flow GPM	Precip. in/h	Precip. in/h
1.5 (Orange)	30	32	1.5	0.16	0.14
	40	35	1.8	0.16	0.14
	50	36	2.3	0.20	0.17
2.0 (Red)	30	33	2.0	0.20	0.18
	40	37	2.2	0.18	0.15
	50	40	2.5	0.17	0.15
3.0 (Black)	30	35	2.9	0.26	0.23
	40	39	3.6	0.26	0.23
	50	41	5.0	0.26	0.23
4.0 (Blue)	30	38	3.8	0.29	0.25
	40	41	4.2	0.28	0.24
	50	42	5.1	0.32	0.28
6.0 (Green)	30	39	5.8	0.42	0.37
	40	43	6.5	0.39	0.34
	50	45	7.5	0.41	0.36

# 550R SERIES

## POP-UP ROTOR



### 3/4" GEAR-DRIVEN ROTOR

The new Irritrol® 550R rotor delivers basic simplicity and dependable action all in one rotor. With its proven 3/4" gear-driven design, 50' of watering radius and a full 5" pop-up, this rotor just gets more done. Installation is made simple with Irritrol's familiar top arc adjustment and all-in-one full- and part-circle operation from 40 to 360 degrees. And, with the ability to quick check the arc with positive left and right stops, set-up time is further reduced. The 550R comes with a wide selection of nozzles (8 standard and 4 low angle nozzles) making it the ideal rotor for your everyday installations.

### KEY FEATURES & BENEFITS

#### FAMILIAR TOP ADJUSTMENT, WET OR DRY

For fast convenient installation

#### REVERSING FULL- AND PART-CIRCLE OPERATION

Allows you to adjust the rotor from 40° to 360°

#### NON-FLUSHING WIPER SEAL

Reduces leaks caused by debris trapped under seal

#### ALL ADJUSTMENTS MADE WITH A STANDARD SCREWDRIVER

No special tools required

#### STANDARD RUBBER COVER

Provides added protection against debris and keeps playing areas safe

#### WIDE SELECTION OF NOZZLES

8 standard and 4 low angle nozzles included with each rotor to handle a wide range of applications

#### POSITIVE LEFT AND RIGHT STOPS (FIXED LEFT STOP)

Reduces set-up time by allowing you to quick check the arc

#### OPTIONAL CHECK VALVE HOLDS UP TO 7' OF ELEVATION CHANGE

Eliminates water waste

#### FULL 5" POP-UP

Fits in competitive footprint without extra digging

## PERFORMANCE DATA

### 550R Rotor - Standard Nozzle

Nozzle	Pressure psi	Radius ft.	Flow GPM	Precip. ■ in/h	Precip. ▲ in/h
1.5	25	33	1.15	0.20	0.23
	35	34	1.38	0.23	0.27
	45	35	1.59	0.25	0.29
	55	35	1.74	0.27	0.32
	65	36	1.88	0.28	0.32
2.0	25	35	1.45	0.23	0.26
	35	36	1.80	0.27	0.31
	45	37	2.12	0.30	0.34
	55	37	2.30	0.32	0.37
	65	37	2.58	0.36	0.42
2.5	25	35	1.75	0.28	0.32
	35	36	2.20	0.33	0.38
	45	37	2.55	0.36	0.41
	55	37	2.80	0.39	0.45
	65	37	3.05	0.43	0.50
3.0	25	36	2.20	0.33	0.38
	35	38	2.60	0.35	0.40
	45	40	3.05	0.37	0.42
	55	40	3.52	0.42	0.49
	65	40	3.80	0.46	0.53
4.0	25	37	2.95	0.41	0.48
	35	40	3.55	0.43	0.49
	45	42	4.10	0.45	0.52
	55	42	4.45	0.49	0.56
	65	43	4.85	0.50	0.58
5.0	25	39	3.75	0.47	0.55
	35	41	4.50	0.52	0.60
	45	43	5.10	0.53	0.61
	55	45	5.75	0.55	0.63
	65	45	6.10	0.58	0.67
6.0	25	39	4.20	0.53	0.61
	35	43	5.20	0.55	0.63
	45	46	6.05	0.60	0.69
	55	47	6.65	0.58	0.67
	65	48	7.25	0.61	0.70
8.0	25	36	5.75	0.85	0.99
	35	43	7.10	0.74	0.85
	45	47	8.05	0.70	0.81
	55	48	8.95	0.75	0.86
	65	50	9.70	0.75	0.86

### 550R Rotor - Low Angle Nozzle

Nozzle	Pressure psi	Radius ft.	Flow GPM	Precip. ■ in/h	Precip. ▲ in/h
1.0 LA	25	25	0.74	0.23	0.26
	35	28	0.94	0.23	0.27
	45	28	1.02	0.23	0.27
	55	29	1.14	0.26	0.30
	65	29	1.25	0.29	0.33
1.5 LA	25	27	1.10	0.29	0.34
	35	30	1.35	0.29	0.33
	45	31	1.52	0.30	0.35
	55	31	1.75	0.35	0.40
	65	31	1.90	0.38	0.44
2.0 LA	25	29	1.40	0.32	0.37
	35	31	1.72	0.34	0.40
	45	32	2.05	0.39	0.45
	55	33	2.25	0.40	0.46
	65	33	2.45	0.43	0.50
3.0 LA	25	29	2.20	0.50	0.58
	35	33	2.60	0.46	0.53
	45	34	3.05	0.51	0.59
	55	36	3.40	0.51	0.58
	65	36	3.70	0.55	0.63

1. Precipitation rates based on half-circle operation
2. ■ square spacing based on 50% diameter of throw
3. ▲ triangular spacing based on 50% diameter of throw

Note: Data collected in zero wind conditions

## OPERATING SPECIFICATIONS

- Inlet: 3/4" female-threaded NPT
- Adjustable arc range: 40° to 360°
- Flow range: .74 – 9.70 gpm
- Recommended operating pressure: 45 psi
- Precipitation rate: .20 – .99 inches per hour
- Overall height (retracted): 7 3/8"
- Radius: 25' – 50'
- Pressure range: 25 to 70 psi
- Standard nozzle trajectory: 25°
- Low angle nozzle trajectory: 12°
- 8 standard and 4 low angle nozzles included  
*(unit comes with 3.0 nozzle pre-installed)*
- Riser height: 5"
- Five-year warranty

## MODELS

Model	Description
550R	3/4" inlet, 5" lawn pop-up
550RS	3/4" inlet, shrub
550RHP	3/4" inlet, 12" high-pop
550R-CV	3/4" inlet, 5" lawn pop-up w/check valve
550R-NP	3/4" inlet, 5" lawn pop-up w/non-potable cover

## OPTIONAL ACCESSORIES

- Recycled-water indicator cover (purple)
- Field-installable check valve (102-7714)

## SPECIFYING INFORMATION

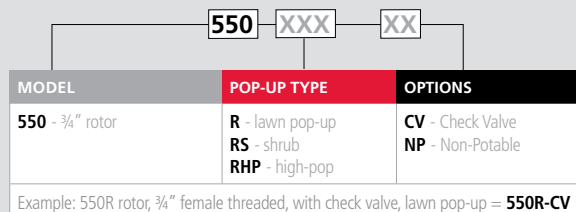

## SAVE VALUABLE SET-UP TIME



# PLATINUM SPORT SERIES

POP-UP ROTOR



## 1" GEAR-DRIVEN ROTOR

The Irritrol® Platinum Sport Series rotor is designed for reliable performance and superior coverage in light commercial and commercial applications. A full 5 ¾-inch pop-up height provides superior coverage in tall grass, while full- and part-circle operation in one unit reduces inventory requirements and increases convenience. Add to this a choice of seven nozzle sizes and it's easy to see why the Platinum Sport Series is quickly becoming an industry favorite.

## KEY FEATURES & BENEFITS

### FULL 5-INCH POP-UP HEIGHT TO NOZZLE

Clears tall grass

### REVERSIBLE CHECK VALVE

Eliminates low-head drainage

### STANDARD RUBBER COVER

Provides added protection against debris and keeps playing areas safe

### ARCVIEW ARC INDICATOR

Simplifies adjustments

### ADJUSTABLE PART-CIRCLE AND UNIDIRECTIONAL FULL-CIRCLE COVERAGE IN ONE UNIT (45°-360°)

Reduces inventory requirements

### AUTOMATIC ARC RETURN

Protects against tampering and vandalism

### WATER-LUBRICATED GEAR DRIVE ASSEMBLY

Enhances reliability

### TOP ADJUST, WET OR DRY

For fast, convenient installation

### OPTIONAL STAINLESS STEEL RISER

Helps to deter vandalism and provides longer life

## PERFORMANCE DATA

Nozzle	Pressure psi	Radius ft.	Flow GPM	Precip. ■ in/h	Precip. ▲ in/h
7.0	40	46	6.8	0.62	0.72
	50	49	7.4	0.65	0.75
	60	49	8.1	0.68	0.78
	70	50	8.9	0.71	0.82
	80	52	9.7	0.72	0.83
	90	52	10.3	0.73	0.84
	100	53	10.9	0.72	0.83
9.0	40	47	7.5	0.66	0.76
	50	51	8.3	0.64	0.73
	60	50	8.9	0.66	0.76
	70	52	9.8	0.70	0.81
	80	54	10.5	0.69	0.80
	90	53	11.2	0.71	0.82
12.0	40	50	10.0	0.77	0.89
	50	53	10.5	0.78	0.90
	60	56	11.5	0.79	0.91
	70	59	12.5	0.83	0.96
	80	60	13.5	0.86	0.99
	90	61	14.3	0.88	1.03
	100	63	15.2	0.90	1.04
16.0	40	52	13.4	0.92	1.06
	50	57	15.0	0.92	1.06
	60	60	15.8	0.90	1.04
	70	61	14.1	0.95	1.09
	80	64	18.4	0.95	1.10
	90	64	19.7	0.98	1.14
	100	66	20.8	1.01	1.17
20.0	40	52	16.1	1.10	1.27
	50	57	18.4	1.05	1.22
	60	61	19.6	1.05	1.21
	70	64	21.0	1.09	1.26
	80	66	22.6	1.03	1.19
	90	68	24.0	1.06	1.23
	100	70	25.3	1.09	1.25
24.0	40	54	15.5	1.10	1.27
	50	60	17.7	0.95	1.09
	60	64	19.8	0.96	1.11
	70	66	21.6	0.99	1.14
	80	68	23.2	1.00	1.15
	90	70	24.9	1.04	1.20
	100	72	26.3	1.00	1.16
27.0	40	55	19.3	1.23	1.42
	50	64	22.0	1.00	1.16
	60	71	23.8	0.91	1.05
	70	72	25.6	0.95	1.10
	80	73	27.3	0.99	1.14
	90	74	29.0	1.02	1.18
100	75	30.5	1.05	1.21	



PTSPORT



PTSPORT-SS

1. Precipitation rates based on half-circle operation
2. ■ square spacing based on 50% diameter of throw
3. ▲ triangular spacing based on 50% diameter of throw

Note: Data collected in zero wind conditions



Nozzle Tree & Tool

## ADDED FEATURES

- Threaded cap-retained riser assembly
- Variable reversing stator
- Seven nozzle sizes (7-27 GPM); pre-installed with 12.0 nozzle
- Small 2.2" exposed surface diameter
- Nozzle support/breakup screw
- Riser pull-up feature on top of nozzle base
- Adjustment/pull up tool supplied
- Locking cap screw
- Five-year warranty

## OPERATING SPECIFICATIONS

- Precipitation rate: .62-1.42 inches per hour
- Radius: 46'-75'
- Flow rate: 6.8-30.5 GPM
- Recommended operating pressure range: 40-100 psi
- Optimum operating pressure: 70 psi
- Inlet size: 1" threaded NPT or 1" BSP
- Nozzle trajectory: 25°
- Arc adjustment: 45°-360° (unidirectional at 360°)

## DIMENSIONS

- Pop-up height to nozzle: 5"
- Body height: 8.8"
- Rubber cover diameter: 2.2"
- Body diameter: 2.7"

## MODELS

Model	Description
PTSPORT	1" inlet sport field rotor
PTSPORT-SS	1" inlet, stainless steel sport field rotor
PTSPORT-NP	1" inlet sport field rotor w/recycled purple cover
PTSPORT-NP-SS	1" inlet stainless steel with recycle purple cover

## OPTIONAL ACCESSORIES

- Recycled-water indicator cover (purple)

## SPECIFYING INFORMATION

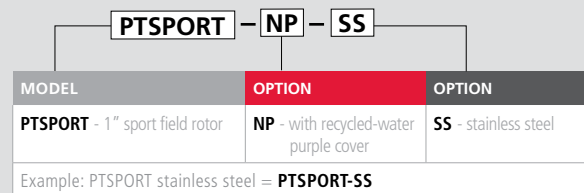

## ARC INDICATOR FEATURE

Top arc indicator allows you to see the arc setting, saving valuable set up time



# SPRAY HEADS & NOZZLES

Quite simply—our spray heads pop up, do their job, then disappear. Just like they're supposed to. And they do it year after year, season after season. Durable construction makes Irritrol® spray heads extremely reliable. And their design makes them easy to install and use.

AT-A-GLANCE					
		I-PRO™ SERIES	I-PRO™ NOZZLES	PRO-VAN NOZZLES	SPECIALTY NOZZLES
		pgs 78-79	pgs 80-81	pgs 82-83	pgs 81
POP-UP HEIGHT	2"				
	3"	●			
	4"	●			
	6"	●			
	12"	●			
FEATURES	SIDE INLET	● (6" and 12" models)			
	CHECK VALVE OPTION	●			
	PRESSURE REGULATOR OPTION	● (Excluding 3" model)			
	PRE-INSTALLED NOZZLE OPTION				
	RECYCLED WATER OPTION	● (Field-installable)			
	RETROFIT OPTION (LESS BODY)	● (Excluding 3" model)			
RADIUS			5', 8', 10', 12', 15'	8', 10', 12', 15', 17'	Specialty
ARC			1/4, 1/3, 1/2, 2/3, 3/4, Full*	Adjustable	9-EST, 9-CST, 9-SST, 15-EST, 15-CST, 15-SST
FLOW RANGE			.06-4.75 GPM	.53-4.60 GPM	.41-1.35 GPM
RECOMMENDED OPERATING PRESSURE			20-50 psi	20-50 psi	20-40 psi
WARRANTY			5 years	5 years	5 years

\* 2/3 and 3/4 arcs not available in 5', 8' and 10' nozzles



## 3", 4", 6" AND 12" MODELS

Irritrol's I-PRO™ Series spray heads combine a pressure-activated wiper seal and advanced formula lubricant that virtually eliminates troublesome stick ups. Add a unique tapered lip design that prevents debris from entering the body and you have a spray head with superior performance. It's rugged and reliable with a textured body style for a non-slip grip and even easier installation. I-PRO offers a 4", 6" and 12" replacement spray head that allows a complete retrofit without having to purchase the body – it even fits the Rain Bird® 1800® Series body. Available in four pop-up heights with side inlet, pressure regulation and check valve options, the I-PRO Series fits most landscape applications.

## KEY FEATURES & BENEFITS

### **PRESSURE-ACTIVATED SEAL WITH LUBRICANT ADDITIVE**

Cleans debris from stem, reduces flow-by during pop-up and prevents leaking between cap and body. Extra lubricant additive further eliminates stick-ups

### **PRE-INSTALLED IN-RISER PRESSURE REGULATOR (OPTIONAL)**

Maintains optimum nozzle performance at 30 psi and eliminates misting in varying pressure applications

### **PRE-INSTALLED CHECK VALVE (OPTIONAL)**

Prevents low-head drainage, eliminating flood or erosion damage by keeping water in lateral pipes in elevation changes up to 14'

### **RETROFITTABLE RISER**

Fits Rain Bird 1800 Series body

### **STURDY AND ROBUST, TEXTURED BODY**

Provides for easy installation with a non-slip grip

### **SIDE AND BOTTOM INLETS ON 6" AND 12" MODELS**

#### **(6" ALSO AVAILABLE IN NON-SIDE INLET)**

Reduces installation time

### **HEAVY-DUTY, STAINLESS STEEL RETRACTION SPRING**

Ensures positive pop-down

### **MALE-THREADED RISER**

Compatible with any female-threaded nozzle in the industry

### **PRE-INSTALLED FLUSH PLUG**

Makes system flushing a breeze and allows for easy nozzle installation

### **RATCHETING RISER**

Easiest ratchet in the market, even while hands are wet, yet won't come out of adjustment!



### SUPERIOR PERFORMING WIPER SEAL

Additional lubricant additive helps eliminate stick-ups

Tapered lip design prevents the intrusion of debris

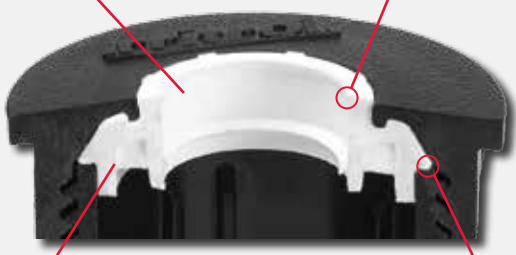

Pressure-activated lip seal ensures a positive seal around the riser and reduces "flow-by"

Lip creates positive seal to prevent body to cap leaks

### REPLACEMENT SPRAY AVAILABLE (4", 6" & 12")

Why pay for a body you're just going to throw away? I-PRO offers a 4", 6" and 12" replacement spray head that is everything but the body! Ideal for maintenance, this spray head also fits right in the can of the Rain Bird® 1800® series for an easy retrofit. With features that are contractor-driven and field-proven, the I-PRO Series is sure to save you time and money.



Easily retrofits to Rain Bird 1800 Series

Remove the "guts" of Rain Bird 1806 spray head

Drop in I-PRO replacement and retrofit is complete

### COMPLETE FAMILY OFFERING

Available in four pop-up heights with side inlet, pressure regulation and check valve options, I-PRO is a spray series for most landscape applications.



### SPECIFYING INFORMATION

MODEL	HEIGHT	SIDE INLET	OPTIONS
<b>I-PRO</b> - I-PRO pop-up spray head series	300 - 3" 400 - 4" 400R - 4", less body 600 - 6" 600R - 6", less body 1200 - 12" 1200R - 12", less body	SI - Side inlet	CV - Pre-installed check valve PR - Pre-installed pressure regulator PR-CV - Pre-installed pressure regulator and check valve

Example: An I-PRO Series sprinkler with a 6" pop-up height, side inlet, pressure regulation option and check valve = **I-PRO600-SI-PR-CV**

### SPECIFICATIONS

- Inlet size: 1/2" female NPT threads
- Exposed diameter: 2 1/4"
- Body diameter: 1 5/8"
- Body height:
  - I-PRO300: 4 7/8"
  - I-PRO400: 5 3/4"
  - I-PRO600: 9 1/4"
  - I-PRO1200: 16"
- Side inlet: 4 3/8" from center of side inlet to top of cap
- Recommended working pressure:
  - Standard: 20-50 psi (max 75 psi)
  - CV: 25-50 psi (max 75 psi)
  - PR: 30-70 psi (max 75 psi)
- Precipitation rate:
  - Spacing: 4' – 15'
  - Flow-by: 0 at 10 psi or greater; .1 GPM otherwise
- Five-year warranty

### MODELS

Model	Description
I-PRO300	3" Pop-Up
I-PRO400	4" Pop-Up
I-PRO400-CV	4" Pop-Up w/Check Valve
I-PRO400-PR	4" Pop-Up w/Pressure Regulator
I-PRO400-PR-CV	4" Pop-Up w/Pressure Regulator and Check Valve
I-PRO600	6" Pop-Up
I-PRO600-CV	6" Pop-Up w/Check Valve
I-PRO600-PR	6" Pop-Up w/Pressure Regulator
I-PRO600-PR-CV	6" Pop-Up w/Pressure Regulator and Check Valve
I-PRO600-SI	6" Pop-Up w/Side Inlet
I-PRO600-SI-PR	6" Pop-Up w/Side Inlet and Pressure Regulator
I-PRO1200-SI	12" Pop-Up w/Side Inlet
I-PRO1200-SI-CV	12" Pop-Up w/Side Inlet and Check Valve
I-PRO1200-SI-PR	12" Pop-Up w/Side Inlet and Pressure Regulator
I-PRO1200-SI-PR-CV	12" Pop-Up w/Side Inlet, Pressure Regulator and Check Valve
I-PRO400R	4" Pop-Up Replacement
I-PRO400R-CV	4" Pop-Up Replacement w/Check Valve
I-PRO400R-PR	4" Pop-Up Replacement w/Pressure Regulator
I-PRO400R-PR-CV	4" Pop-Up Replacement w/Pressure Regulator and Check Valve
I-PRO600R	6" Pop-Up Replacement
I-PRO600R-CV	6" Pop-Up Replacement w/Check Valve
I-PRO600R-PR	6" Pop-Up Replacement w/Pressure Regulator
I-PRO600R-PR-CV	6" Pop-Up Replacement w/Pressure Regulator and Check Valve
I-PRO1200R	12" Pop-Up Replacement
I-PRO1200R-CV	12" Pop-Up Replacement w/Check Valve
I-PRO1200R-PR	12" Pop-Up Replacement w/Pressure Regulator
I-PRO1200R-PR-CV	12" Pop-Up Replacement w/Pressure Regulator and Check Valve

### OPTIONAL ACCESSORIES

- Recycled-water indicator cap (I-PRO-NPC)
- Field-installable check valve (I-PRO-CV)

# I-PRO™ NOZZLE SERIES



## MPR NOZZLES

Irritrol's I-PRO™ nozzles with Matched Precipitation Rate are designed to simplify your design process while delivering the precision performance you've come to expect. An I-PRO MPR nozzle ensures even water distribution within an arc family allowing for accurate control of precipitation rate, radius and flow. Runoff and over-watering are both dramatically reduced. And compared to the competition, these I-PRO nozzles give an equal to or lower on-average precipitation and flow rate adding greater irrigation efficiency. Color-coded on top for quick radius identification, users will be able to easily verify proper nozzle installation—whether the system is on or off. Available in 5 radius sizes and 6 arc settings\*, I-PRO nozzles are female-threaded and include a ribbed-edge design for a non-slip grip. Compatible with all Irritrol spray heads as well as any male-threaded riser in the industry, Irritrol's I-PRO nozzle series are just the right nozzles to get the job done.

## KEY FEATURES & BENEFITS

### MATCHED PRECIPITATION RATES

Ensures even water distribution within each family

### LOW-FLOW RATES

Allow for more sprinklers to be installed on the same zone

### COLOR-CODED TOP

For quick and easy radius identification

### FEMALE-THREADED

Compatible with any male-threaded riser in the industry

### RIBBED-EDGE DESIGN

Provides for a non-slip grip



\*5', 8' and 10' nozzles are not available in TT and TQ arc settings





## VARIABLE ARC NOZZLES

Featuring an exclusive “Smart Grip” head design that requires no tools, Irritrol® Pro-VAN nozzles provide the industry’s easiest 0° to 360° arc adjustment—even when wet—while ensuring precision adjustment for pinpoint coverage. No more dry spots on the lawn. No more wasted water on sidewalks or driveways. Pro-VANs are available in five radii, from 8' to 17', and each allows for up to a 25% radius reduction for even further fine tuning. Plus, because each nozzle is compatible with all Irritrol spray heads, as well as any male-threaded riser in the industry, nozzle inventory can be dramatically reduced. Additional features include a visible left-stop arrow at the top of the nozzle to ensure setting accuracy and color-coding for easy radius identification.

## KEY FEATURES & BENEFITS

### FULLY ADJUSTABLE ARC – FROM 0° TO 360°

Reduces inventory by meeting the needs of any size or shape landscape

### PRECISION ADJUSTMENT

Eliminates dry spots on lawns and reduces water waste on sidewalks, etc.

### EXCLUSIVE “SMART GRIP” HEAD DESIGN

Requires no tools and provides the industry’s easiest arc adjustment – even when wet

### COMPATIBLE WITH ANY MALE-THREADED RISER IN THE INDUSTRY

Reduces inventory requirements

### VISIBLE LEFT-STOP ARROW ON TOP OF NOZZLE

Ensures setting accuracy

## PERFORMANCE DATA

### 8' Series with 5° Trajectory ●

Nozzle	Pressure psi	Radius ft.	Flow GPM	Precip. ■ in/h	Precip. ▲ in/h
360° 	20	8	1.72	2.59	2.99
	30	8	2.13	3.20	3.70
	40	9	2.48	3.73	4.31
	50	9	2.78	4.18	4.83
270° 	20	8	1.36	2.73	3.15
	30	9	1.65	3.31	3.82
	40	9	1.89	3.79	4.38
180° 	20	9	0.87	2.62	3.02
	30	9	1.07	3.22	3.72
	40	9	1.23	3.70	4.27
90° 	20	9	0.53	3.19	3.68
	30	10	0.64	3.85	4.45
	40	10	0.72	4.33	5.00
	50	10	0.78	4.69	5.42

### 10' Series with 10° Trajectory ●

Nozzle	Pressure psi	Radius ft.	Flow GPM	Precip. ■ in/h	Precip. ▲ in/h
360° 	20	10	1.98	1.91	2.20
	30	10	2.41	2.32	2.68
	40	11	3.19	3.07	3.55
	50	12	3.59	3.46	3.99
270° 	20	10	1.60	2.05	2.37
	30	11	1.95	2.50	2.88
	40	12	2.26	2.89	3.34
180° 	20	10	1.13	2.18	2.51
	30	11	1.38	2.66	3.07
	40	12	1.58	3.04	3.51
90° 	20	11	0.62	2.39	2.76
	30	12	0.77	2.96	3.42
	40	12	0.89	3.43	3.96
	50	13	1.00	3.85	4.45

### 12' Series with 15° Trajectory ●

Nozzle	Pressure psi	Radius ft.	Flow GPM	Precip. ■ in/h	Precip. ▲ in/h
360° 	20	11	2.26	1.51	1.74
	30	12	2.79	1.86	2.15
	40	13	3.20	2.14	2.47
	50	13	3.62	2.42	2.79
270° 	20	11	1.85	1.65	1.90
	30	12	2.29	2.04	2.36
	40	13	2.64	2.35	2.72
180° 	20	11	1.33	1.78	2.05
	30	12	1.63	2.18	2.52
	40	13	1.89	2.53	2.92
90° 	20	12	0.75	2.01	2.32
	30	13	0.93	2.49	2.87
	40	14	1.06	2.83	3.27
	50	14	1.21	3.24	3.74

### 15' Series with 20° Trajectory ●

Nozzle	Pressure psi	Radius ft.	Flow GPM	Precip. ■ in/h	Precip. ▲ in/h
360° 	20	14	2.76	1.18	1.36
	30	15	3.35	1.43	1.65
	40	15	3.87	1.66	1.91
	50	16	4.31	1.84	2.13
270° 	20	14	2.36	1.35	1.55
	30	15	2.89	1.65	1.90
	40	16	3.30	1.88	2.17
180° 	20	15	1.70	1.45	1.68
	30	16	2.09	1.79	2.06
	40	16	2.42	2.07	2.39
90° 	20	17	2.71	2.32	2.68
	30	16	1.20	2.05	2.37
	40	17	1.40	2.40	2.77
	50	17	1.56	2.67	3.08

### 17' Series with 26° Trajectory ●

Nozzle	Pressure psi	Radius ft.	Flow GPM	Precip. ■ in/h	Precip. ▲ in/h
360° 	20	14	2.90	0.97	1.12
	30	16	3.60	1.20	1.38
	40	17	4.10	1.37	1.58
	50	17	4.60	1.53	1.77
270° 	20	14	2.50	1.11	1.28
	30	16	3.10	1.38	1.59
	40	17	3.60	1.60	1.85
180° 	20	15	1.90	1.27	1.46
	30	17	2.40	1.60	1.85
	40	17	2.70	1.80	2.08
90° 	20	15	1.20	2.00	2.31
	30	17	1.50	2.00	2.31
	40	18	1.70	2.26	2.62
	50	18	1.90	2.53	2.92

- Square spacing based on 50% diameter of throw
- ▲ Triangle spacing based on 50% diameter of throw

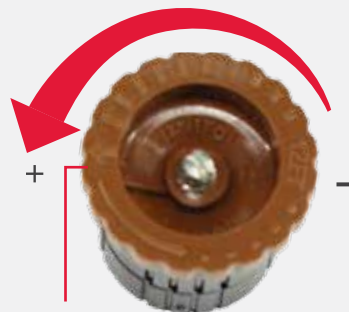

Top-visible arrow quickly indicates left edge of arc setting when adjusted

## AVAILABLE IN 5 DIFFERENT RADII



8'

10'

12'

15'

17'

## ADDED FEATURES

- Color-coded for easy radius identification
- Pre-assembled at 0°
- Stainless steel radius adjustment screw allows for up to 25% radius reduction
- Five-year warranty

## SPECIFICATIONS

- Flow rate: 0.53 - 4.60 GPM
- Recommended operating pressure range: 20-50 psi
- Maximum operation range: 75 psi

## MODELS

Model	Description
PRO-VAN8	8' variable arc pattern
PRO-VAN10	10' variable arc pattern
PRO-VAN12	12' variable arc pattern
PRO-VAN15	15' variable arc pattern
PRO-VAN17	17' variable arc pattern

## SPECIFYING INFORMATION

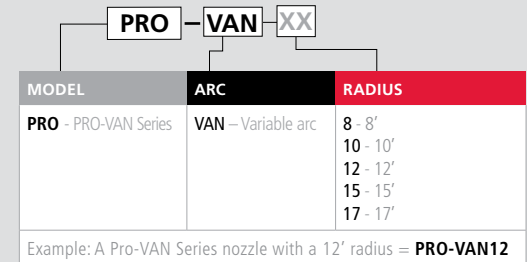

# 533 BUBBLER



## SPECIFICATIONS

- Recommended working pressure: 20-40 psi
- Flow rate: 1.36-5.90 GPM
- Maximum operation pressure: 75 psi
- Inlet size: 1/2" female NPT threads
- Five-year warranty

## DIMENSIONS

- H: 1 1/8"
- Top diameter: 1 1/16"

## PERFORMANCE DATA

	90° Adjustment	180° Adjustment	270° Adjustment	360° Adjustment
psi	GPM	GPM	GPM	GPM
15	1.36	2.37	2.85	2.97
20	1.56	2.75	3.31	3.45
25	1.77	3.04	3.71	3.86
30	1.93	3.36	4.05	4.32
35	2.01	3.59	4.37	5.51
40	2.25	3.84	4.70	5.90

Designed for localized watering of flower beds, roses, shrub areas and ground covers, Irritrol's 533 Bubbler is the only hand-adjustable flood bubbler that shuts down to a true zero flow.

## KEY FEATURES & BENEFITS

### SIMPLE TWIST TOP FLOW ADJUSTMENT

Easily adjusts by hand with no tools needed!

### TRUE ZERO FLOW SHUT-OFF

Allows for temporary maintenance needs

### FULLY ADJUSTABLE ARC AND FLOW RATE

For flexibility in precise watering needs

### HEAVY-DUTY ABS MATERIAL

Provides durability and long-lasting life

### AVAILABLE IN LAVENDER

To easily identify non-potable water systems



533 Bubbler



533NP Bubbler

# HS100 (SHRUB ADAPTER)

Designed for use with all Irritrol spray head nozzles in shrub and other low traffic areas.



HS100

## FEATURES

- Threads directly onto riser
- UV-treated for above-ground mount
- Manufactured of heavy-duty ABS
- Accepts all Irritrol nozzles and any other female-threaded nozzle
- Five-year warranty

## SPECIFICATIONS

- Inlet size: 1/2" female NPT threads.

# I-PRO-NPC (RECYCLED-WATER CAP)

Purple cap assembly (includes seal) replaces standard spray cap on I-PRO Series to easily identify non-potable water systems.



I-PRO-NPC

## FEATURES

- Threads onto all I-PRO Series spray head bodies as well as Rain Bird® 1800® Series bodies
- UV-resistant
- Manufactured of heavy-duty ABS material

# I-PRO-CV (I-PRO CHECK VALVE)

For use in I-PRO Series spray heads for protection against low-head drainage. Also reduces water waste and erosion.



I-PRO-CV

## FEATURES

- Field-installable
- Holds back up to 10' of elevation change
- One-piece molded plastic
- Manufactured of durable polyolefin material

# SUPER BLUE FLEX™



## BLUE FLEX PIPE

With a strong product heritage and proven years of performance, this tubing is designed to simplify spray head installation making it ideal for challenging landscapes and hard-to-reach areas.



EHF1295-010-D  
Flex pipe ½" 100' coil

### KEY FEATURES & BENEFITS

#### **DURABLE PREMIUM GRADE VIRGIN LINEAR, LOW-DENSITY POLYETHYLENE**

Achieves higher psi strength and performance over time vs. competitive products

#### **HIGHLY FLEXIBLE**

For ease of use

#### **EASILY UNWINDS FROM CENTER OF COIL**

For added convenience

### ADDED FEATURES

- Coils are shrink-wrapped for ease of handling
- Low-density design protects tubing from landscape
- Five-year warranty

### SPECIFICATIONS

- Maximum working pressure: 120 psi at 100° F
- Inside diameter: .49"
- Outside diameter: .68"
- Wall thickness: .095"
- Nominal size: .50"
- Coil size: 100'



# BLUE FLEX ASSEMBLIES



Available in two popular lengths, these sturdy, flexible assemblies protect spray head risers and pipes from breaking when hit or run over by equipment.

## KEY FEATURES & BENEFITS

### STANDARD 8-INCH LENGTH

Provides greater flexibility and strength than competitors' 6-inch models

### PRE-ASSEMBLED

Saves time and money

### TAPE-FREE FITTING INSTALLATION

Makes installation faster and easier

### FEWER THREADED JOINTS

Minimizes leaks

# BLUE FLEX FITTINGS



Used with Super Blue Flex™ pipe for installation of spray head risers. Ideal for use in high-traffic areas.

## ADDED FEATURES

- Easily adjusts sprinkler head to required grade
- Compatible for below-grade installation
- Five-year warranty

## SPECIFICATIONS

- Operating pressure range: 25-75 psi
- Maximum operating pressure: 85 psi
- Pressure-tested to 120 psi

## MODELS

Model	Description
B-FLEX8-05	8" x 1/2" male x 1/2" street ell
B-FLEX12-05	12" x 1/2" male x 1/2" street ell
B-FLEX8-0575	8" x 1/2" male x 3/4" street ell
B-FLEX12-0575	12" x 1/2" male x 3/4" street ell

## SPECIFYING INFORMATION

B-FLEX - XX - XXXX

MODEL	LENGTH	FITTING
B-FLEX - Blue Flex swing assembly	8 - 8" 12 - 12"	05 - 1/2" male x 1/2" street ell 0575 - 1/2" male x 3/4" street ell

Example: A 12" swing assembly with 3/4" street elbow = **B-FLEX12-0575**

## SUPER BLUE FLEX ASSEMBLY FRICTION LOSS DATA

MODELS	GPM FLOW						
	1	2	3	4	5	6	7
B-FLEX8-05	0.04	0.11	0.27	0.47	0.85	1.22	1.78
B-FLEX12-05	0.05	0.15	0.36	0.62	1.13	1.62	2.37
B-FLEX8-0575	0.05	0.14	0.31	0.60	1.07	1.65	2.29
B-FLEX12-0575	0.06	0.18	0.41	0.80	1.42	2.20	3.05

## ADDED FEATURES

- Five-year warranty

## MODELS

Model	Description
FFP-T	1/2" barbed tee
FFP-75EM	3/4" male x 1/2" barb elbow
FFP-50EM	1/2" male x 1/2" barb elbow
FFP-C	1/2" barbed coupler

# RESOURCES

We are here to help. From friction loss tables to wire sizing, we have all the stats you need to keep working hard.



# COMMUNICATIONS DIRECTORY

## IRRITROL HEADQUARTERS

**Phone:** 800-634-TURF (8873)

**Fax:** 800-862-8676

**Website:** [www.irritrol.com](http://www.irritrol.com)

## ORDER SERVICES

**Phone:** 800-883-1234

**Fax:** 800-883-5432

**email:** [orderservices@irritrol.com](mailto:orderservices@irritrol.com)

## CUSTOMER RESOURCE CENTER

At your service to provide literature, promotional and product information, and branch support, as well as answer any questions regarding doing business with Irritrol.

**Phone:** 800-634-TURF (8873)

**Fax:** 800-862-8676

**email:** [crc@irritrol.com](mailto:crc@irritrol.com)

## TECHNICAL SUPPORT

**Phone:** 800-634-TURF (8873)

**email:** [irrigationsupport@irritrol.com](mailto:irrigationsupport@irritrol.com)

**Rain Master® Control Systems:** 800-777-1477

## CONTROLLER REPAIR

**Phone:** 800-899-2058

## FORMULAS

To Calculate:	U.S.	METRIC
<b>Precipitation Rates</b>		
Equilateral Triangular Spacing	P.R.= (in/hr) $\frac{(\text{gpm of } 360) \times 96.25}{(\text{Head spacing})^2 \times .866}$	P.R.= (mm/hr) $\frac{\text{m}^3/\text{hr of } 360 \times 1000}{\text{m}^2 \times .866}$
Square/Rectangular Spacing	P.R.= (in/hr) $\frac{(\text{gpm of } 360) \times 96.25}{\text{Head spacing} \times \text{row spacing}}$	P.R.= (mm/hr) $\frac{\text{m}^3/\text{hr of } 360 \times 1000}{\text{Head spacing} \times \text{row spacing}}$
Square/Rectangular Spacing for Specific Arc	P.R.= (in/hr) $\frac{(34650 \times \text{gpm (for any arc)})}{\text{Degrees of arc} \times \text{head spacing} \times \text{row spacing}}$	P.R.= (mm/hr) $\frac{\text{m}^3/\text{hr (for any arc)} \times 1000}{\text{Degrees of arc} \times \text{head spacing} \times \text{row spacing}}$
<b>Horsepower</b>		
	H.P.= $\frac{\text{gpm} \times \text{ft. of Head}}{3,900 \times \text{pump efficiency}}$ (expressed as a decimal)	
<b>Station Run Time</b>		
	S.R.T.= (min/wk) $\frac{\text{Total weekly req'd (inch/wk)} \times 60 \text{ (min/hr)}}{\text{Precipitation rate (in/hr)}}$	S.R.T.= (min/wk) $\frac{\text{Total weekly req'd (inch/wk)} \times 60 \text{ (min/hr)}}{\text{Precipitation rate (mm/hr)}}$
<b>Pipe Velocity</b>		
	V= (ft/sec) $\frac{0.4085 \times \text{Flow (GPM)}}{(\text{Inside pipe diameter in inches})^2}$	V= (m/sec) $\frac{1273.24 \times \text{Flow (l/sec)}}{(\text{Inside pipe diameter in millimeters})^2}$
<b>Scheduling Coefficient</b>		
	S.C.= $\frac{\text{Average precipitation rate (in/hr)}}{\text{Lowest precipitation rate (in/hr)}}$	S.C.= $\frac{\text{Average precipitation rate (mm/hr)}}{\text{Lowest precipitation rate (mm/hr)}}$
<b>Slope</b>		
	S = $\frac{\text{Rise (measure of length)}}{\text{Run (measure of length)}}$	

## SPRINKLER SPACING AND PRECIPITATION RATE FORMULAS

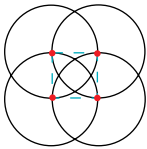
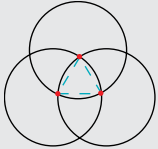
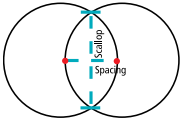
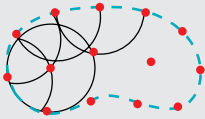
<p>Square-spaced sprinklers in pattern:</p> $\frac{\text{GPM of full circle} \times 96.3}{(\text{spacing})^2}$		<p>Square Spacing</p> <ul style="list-style-type: none"> <li>- No wind — 55% of diameter</li> <li>- 4 mph wind — 50% of diameter</li> <li>- 8 mph wind — 45% of diameter</li> </ul>
<p>Triangular-spaced sprinklers in pattern:</p> $\frac{\text{GPM of full circle} \times 96.3}{(\text{spacing})^2 (0.866)}$		<p>Triangular Spacing</p> <ul style="list-style-type: none"> <li>- No wind — 50% of diameter</li> <li>- 4 mph wind — 55% of diameter</li> <li>- 8 mph wind — 50% of diameter</li> </ul>
<p>Single row:</p> $\frac{\text{GPM of full circle} \times 96.3}{(\text{spacing}) (\text{scallop})}$		<p>Single-Row Spacing</p> <ul style="list-style-type: none"> <li>- No wind — 50% of diameter</li> <li>- 4 mph wind — 50% of diameter</li> <li>- 8 mph wind — 45% of diameter</li> </ul>
<p>Area and flow:</p> $\frac{\text{Total GPM of zone} \times 96.3}{\text{Total irrigated square feet of zone}}$		

Irritrol does not recommend designing for 0 mph wind conditions. Design in consideration of the worst wind conditions.

**CONVERSION FACTORS**

To Convert:	From	To	Multiply by
<b>AREA</b>	acres	feet <sup>2</sup>	43,560
	acres	meters <sup>2</sup>	4046.8
	meters <sup>2</sup>	feet <sup>2</sup>	10.764
	feet <sup>2</sup>	inches <sup>2</sup>	144
	inches <sup>2</sup>	centimeters <sup>2</sup>	6.452
	hectares	meters <sup>2</sup>	10,000
	hectares	acres	2.471
<b>POWER</b>	kilowatts	horsepower	1.3410
<b>FLOW</b>	feet <sup>3</sup> /minute	meters <sup>3</sup> /second	0.0004719
	feet <sup>3</sup> /second	meters <sup>3</sup> /second	.02832
	yards <sup>3</sup> /minute	meters <sup>3</sup> /second	.01274
	gallons/minute	meters <sup>3</sup> /hour	.22716
	gallons/minute	liters/minutes	3.7854
	gallons/minute	liters/second	.06309
	meters <sup>3</sup> /hour	liters/minute	16.645
	meters <sup>3</sup> /hour	liters/second	.2774
	liters/minute	liters/second	60
<b>LENGTH</b>	feet	inches	12
	inches	centimeters	2.540
	feet	meters	.30481
	kilometers	miles	.6214
	miles	feet	5,280
	miles	meters	1609.34
	millimeters	inch	.03937
<b>PRESSURE</b>	psi	kilopascals	6.89476
	psi	bars	.068948
	Bars	kilopascals	100
	psi	feet of head	2.31
<b>VELOCITY</b>	feet/second	meters/second	.3048
<b>VOLUME</b>	feet <sup>3</sup>	gallons	7.481
	feet <sup>3</sup>	liters	28.32
	meters <sup>3</sup>	feet <sup>3</sup>	35.31
	meters <sup>3</sup>	yard <sup>3</sup>	1.3087
	yards <sup>3</sup>	feet <sup>3</sup>	27
	yards <sup>3</sup>	gallons	202
	acres/feet	feet <sup>3</sup>	43,560
	gallons	meters <sup>3</sup>	.003785
	gallons	liters	3.785
	imperial gallons	gallons	1.833

**FRICTION LOSS FORMULAS**
**Friction Loss Tables are based upon the following:**

Hazen-Williams Equation:

$$H_f = (0.2083) (100 / C)^{1.852} (Q^{1.852} / D^{4.866})$$

(The result is multiplied by .433 to give psi loss for 100 feet of pipe)

The velocity values were derived using the following:

$$V = (0.408 \times Q_{gpm}) / d^2$$

(The average inside diameter of OD controlled pipe was based upon subtracting two times the minimum wall thickness plus one-half of the wall thickness tolerance from the outside diameter.)

- Pressure ratings for plastic pipes are based on 23° C or 73.4° F
- Head loss decreases (increases) approximately 1% for every 3 degrees F above (below) the reference temperature (73.4° F)













FRICITION LOSS CHARACTERISTICS

# TYPE 'K' COPPER TUBING

Size: 1/2" thru 3"      Flow: 1 thru 600GPM  
 ASTM B 88 C=140 PSI LOSS PER 100 FEET OF PIPE (PSI/100 FT)

size	1/2"	5/8"	3/4"	1"	1 1/4"	1 1/2"	2"	2 1/2"	3"	
Avg.ID	0.527	0.652	0.745	0.995	1.245	1.481	1.959	2.435	2.907	
Pipe OD	0.625	0.750	0.875	1.125	1.375	1.625	2.125	2.625	3.125	
Avg Wall	0.049	0.049	0.065	0.065	0.065	0.072	0.083	0.095	0.109	
Flow GPM	Velocity FPS	PSI Loss	Velocity FPS	PSI Loss	Velocity FPS	PSI Loss	Velocity FPS	PSI Loss	Velocity FPS	PSI Loss
1	1.47	1.09	0.96	0.39	0.74	0.20	0.41	0.05	0.26	0.02
2	2.94	3.94	1.92	1.40	1.47	0.73	0.82	0.18	0.53	0.06
3	4.41	8.35	2.88	2.97	2.21	1.55	1.24	0.38	0.79	0.13
4	5.88	14.23	3.84	5.05	2.94	2.64	1.65	0.65	1.05	0.22
5	7.35	21.51	4.80	7.64	3.68	3.99	2.06	0.98	1.32	0.33
6	8.81	30.15	5.76	10.70	4.41	5.59	2.47	1.37	1.58	0.46
7	10.28	40.12	6.72	14.24	5.15	7.44	2.88	1.82	1.84	0.61
8	11.75	51.37	7.68	18.24	5.88	9.53	3.30	2.33	2.11	0.78
9	13.22	63.90	8.64	22.68	6.62	11.85	3.71	2.90	2.37	0.97
10	14.69	77.66	9.60	27.57	7.35	14.41	4.12	3.52	2.63	1.18
12			11.52	38.64	8.82	20.20	4.95	4.94	3.16	1.66
14			13.44	51.41	10.29	26.87	5.77	6.57	3.69	2.21
16			15.36	65.83	11.76	34.41	6.59	8.42	4.21	2.83
18			17.28	81.88	13.23	42.80	7.42	10.47	4.74	3.52
20					14.70	52.02	8.24	12.72	5.26	4.28
22					16.17	62.06	9.07	15.18	5.79	5.10
24					17.64	72.91	9.89	17.84	6.32	5.99
26							10.71	20.69	6.84	6.95
28							11.54	23.73	7.37	7.97
30							12.36	26.96	7.90	9.06
32							13.19	30.39	8.42	10.21
34							14.01	34.00	8.95	11.42
36							14.84	37.79	9.48	12.70
38							15.66	41.77	10.00	14.04
40							16.48	45.94	10.53	15.43
42							17.31	50.28	11.06	16.89
44									11.58	18.41
46									12.11	19.99
48									12.63	21.63
50									13.16	23.33
55									14.48	27.84
60									15.79	32.70
65									17.11	37.93
70									18.43	43.51
75									13.02	18.70
80									13.95	21.24
85									14.88	23.94
90									15.81	26.79
95									16.74	29.78
100									17.67	32.91
110									18.60	36.19
120										
130									11.69	11.07
140									12.76	13.01
150									13.82	15.08
160									14.88	17.30
170									15.95	19.66
180									17.01	22.16
190									18.07	24.79
200										
220									11.01	7.69
240									11.70	8.60
260									12.39	9.56
280									13.07	10.57
300									13.76	11.62
320									15.14	13.87
340									16.51	16.29
360									17.89	18.90
380									19.27	21.68
400										
420										
440										
460										
480										
500										

Shaded area represents velocities over 7 fps.  
 Use with caution, where water hammer is a concern.

See pg 93 for friction loss formulas













**FRICITION LOSS CHARACTERISTICS**

**HDPE DR 13.5 128 PSI (IPS SIZE, OD CONTROLLED)**

Size: 3" thru 18" Flow: 1 thru 4000GPM

ANSI/ASAE S376.2 PE3408, ASTM D2239 C=150 PSI LOSS PER 100 FEET OF PIPE (PSI/100 FT)

size	3"	4"	6"	8"	10"	12"	14"	16"	18"	
Avg.ID	2.950	3.794	5.583	7.269	9.062	10.748	11.802	13.488	15.174	
Pipe OD	3.500	4.500	6.625	8.625	10.750	12.750	14.000	16.000	18.000	
Avg Wall	0.275	0.353	0.521	0.678	0.844	1.001	1.099	1.256	1.413	
Min Wall	0.259	0.333	0.491	0.639	0.796	0.944	1.037	1.185	1.333	
Flow GPM	Velocity FPS	PSI Loss	Velocity FPS	PSI Loss	Velocity FPS	PSI Loss	Velocity FPS	PSI Loss	Velocity FPS	PSI Loss
50	2.34	0.31	1.42	0.09	0.65	0.01				
60	2.81	0.43	1.70	0.13	0.79	0.02				
70	3.28	0.58	1.98	0.17	0.92	0.03				
80	3.75	0.74	2.27	0.22	1.05	0.03				
90	4.22	0.92	2.55	0.27	1.18	0.04				
100	4.69	1.11	2.83	0.33	1.31	0.05	0.77	0.01		
120	5.63	1.56	3.40	0.46	1.57	0.07	0.93	0.02		
140	6.56	2.08	3.97	0.61	1.83	0.09	1.08	0.03		
160	7.50	2.66	4.54	0.78	2.09	0.12	1.24	0.03		
180	8.44	3.31	5.10	0.97	2.36	0.15	1.39	0.04		
200			5.67	1.18	2.62	0.18	1.54	0.05	0.99	0.02
220			6.24	1.41	2.88	0.22	1.70	0.06	1.09	0.02
240			6.80	1.66	3.14	0.25	1.85	0.07	1.19	0.02
260			7.37	1.92	3.40	0.29	2.01	0.08	1.29	0.03
280			7.94	2.20	3.67	0.34	2.16	0.09	1.39	0.03
300					3.93	0.38	2.32	0.11	1.49	0.04
320					4.19	0.43	2.47	0.12	1.59	0.04
340					4.45	0.48	2.63	0.13	1.69	0.05
360					4.71	0.54	2.78	0.15	1.79	0.05
380					4.97	0.59	2.93	0.16	1.89	0.06
400					5.24	0.65	3.09	0.18	1.99	0.06
450					5.89	0.81	3.47	0.22	2.24	0.08
500					6.54	0.98	3.86	0.27	2.48	0.09
550					7.20	1.17	4.25	0.33	2.73	0.11
600					7.85	1.38	4.63	0.38	2.98	0.13
650					8.51	1.60	5.02	0.44	3.23	0.15
700							5.41	0.51	3.48	0.17
750							5.79	0.58	3.73	0.20
800							6.18	0.65	3.97	0.22
850							6.56	0.73	4.22	0.25
900							6.95	0.81	4.47	0.28
950							7.34	0.90	4.72	0.31
1000							7.72	0.98	4.97	0.34
1050							8.11	1.08	5.22	0.37
1100									5.47	0.40
1150							5.71	0.44	4.06	0.19
1200							5.96	0.47	4.24	0.21
1250							6.21	0.51	4.41	0.22
1300							6.46	0.55	4.59	0.24
1350							6.71	0.59	4.77	0.26
1400							6.96	0.63	4.94	0.27
1450							7.20	0.67	5.12	0.29
1500							7.45	0.71	5.30	0.31
1550							7.70	0.76	5.47	0.33
1600							7.95	0.80	5.65	0.35
1650							8.20	0.85	5.83	0.37
1700									6.00	0.39
1750									6.18	0.41
1800									6.36	0.44
1900									6.71	0.48
2000									7.06	0.53
2100									7.42	0.58
2200									7.77	0.63
2300									8.12	0.69
2400									7.03	0.47
2500									7.32	0.51
2600									7.62	0.55
2700									7.91	0.59
2800									8.20	0.63
2900									6.50	0.35
3000									6.73	0.37
3300									7.40	0.44
3600									8.07	0.52
3900									6.91	0.34
4000									7.09	0.36

Shaded area represents velocities over 5 fps.  
Use with caution.

See pg 93 for friction loss formulas

FRICITION LOSS

FRICITION LOSS CHARACTERISTICS

C900 DR 18 CLASS 150 (C.I.O.D.)										
Size: 4" thru 12"					Flow: 25 thru 8500GPM					
AWWA C900 ASTM D1784 C=150					PSI LOSS PER 100 FEET OF PIPE (PSI/100 FT)					
size	4"		6"		8"		10"		12"	
Avg.ID	4.234		6.088		7.984		9.792		11.646	
Pipe OD	4.800		6.900		9.050		11.100		13.200	
Avg Wall	0.283		0.406		0.533		0.654		0.777	
Min Wall	0.267		0.383		0.503		0.617		0.733	
Flow GPM	Velocity FPS	PSI Loss	Velocity FPS	PSI Loss	Velocity FPS	PSI Loss	Velocity FPS	PSI Loss	Velocity FPS	PSI Loss
25	0.57	0.01	0.28	0.00	0.16	0.00	0.11	0.00	0.08	0.00
50	1.14	0.05	0.55	0.01	0.32	0.00	0.21	0.00	0.15	0.00
75	1.71	0.11	0.83	0.02	0.48	0.01	0.32	0.00	0.23	0.00
100	2.28	0.19	1.10	0.03	0.64	0.01	0.43	0.00	0.30	0.00
125	2.84	0.29	1.38	0.05	0.80	0.01	0.53	0.00	0.38	0.00
150	3.41	0.41	1.65	0.07	0.96	0.02	0.64	0.01	0.45	0.00
175	3.98	0.54	1.93	0.09	1.12	0.02	0.74	0.01	0.53	0.00
200	4.55	0.69	2.20	0.12	1.28	0.03	0.85	0.01	0.60	0.01
225	5.12	0.86	2.48	0.15	1.44	0.04	0.96	0.01	0.68	0.01
250	5.69	1.05	2.75	0.18	1.60	0.05	1.06	0.02	0.75	0.01
275	6.26	1.25	3.03	0.21	1.76	0.06	1.17	0.02	0.83	0.01
300	6.83	1.47	3.30	0.25	1.92	0.07	1.28	0.02	0.90	0.01
325	7.40	1.70	3.58	0.29	2.08	0.08	1.38	0.03	0.98	0.01
350	7.97	1.95	3.85	0.33	2.24	0.09	1.49	0.03	1.05	0.01
375	8.53	2.22	4.13	0.38	2.40	0.10	1.60	0.04	1.13	0.02
400	9.10	2.50	4.40	0.43	2.56	0.11	1.70	0.04	1.20	0.02
450			4.95	0.53	2.88	0.14	1.91	0.05	1.35	0.02
500			5.50	0.65	3.20	0.17	2.13	0.06	1.50	0.03
550			6.05	0.77	3.52	0.21	2.34	0.08	1.65	0.03
600			6.60	0.91	3.84	0.24	2.55	0.09	1.80	0.04
700			7.71	1.20	4.48	0.32	2.98	0.12	2.11	0.05
800			8.81	1.54	5.12	0.41	3.40	0.15	2.41	0.07
900			9.91	1.92	5.76	0.51	3.83	0.19	2.71	0.08
1000					6.40	0.62	4.26	0.23	3.01	0.10
1100					7.04	0.74	4.68	0.28	3.31	0.12
1200					7.68	0.87	5.11	0.32	3.61	0.14
1300					8.32	1.01	5.53	0.38	3.91	0.16
1400					8.96	1.16	5.96	0.43	4.21	0.19
1500					9.60	1.32	6.38	0.49	4.51	0.21
1600					10.24	1.49	6.81	0.55	4.81	0.24
1700							7.23	0.62	5.11	0.27
1800							7.66	0.69	5.41	0.29
1900							8.08	0.76	5.72	0.33
2000							8.51	0.83	6.02	0.36
2100							8.94	0.91	6.32	0.39
2200							9.36	0.99	6.62	0.43
2300									6.92	0.46
2400									7.22	0.50
2500									7.52	0.54
2600									7.82	0.58
2700									8.12	0.63
2800										
2900										
3000										
3100										
3200										
3300										
3400										
3500										
3600										
3800										
3900										
4000										
4200										
4400										
4600										
4800										
5000										
5500										
6000										
6500										
7000										
7500										
8000										
8500										

Shaded area represents velocities over 5 fps.  
Use with caution.

See pg 93 for friction loss formulas

FRICITION LOSS CHARACTERISTICS

### C900 DR 25 CLASS 100 (C.I.O.D.)

Size: 4" thru 12"      Flow: 25 thru 8500GPM  
 AWWA C900   ASTM D1784   C=150      PSI LOSS PER 100 FEET OF PIPE (PSI/100 FT)

size	4"		6"		8"		10"		12"	
Avg.ID	4.392		6.314		8.282		10.158		12.080	
Pipe OD	4.800		6.900		9.050		11.100		13.200	
Avg Wall	0.204		0.293		0.384		0.471		0.560	
Min Wall	0.192		0.276		0.362		0.444		0.528	
Flow GPM	Velocity FPS	PSI Loss	Velocity FPS	PSI Loss	Velocity FPS	PSI Loss	Velocity FPS	PSI Loss	Velocity FPS	PSI Loss
25	0.53	0.01	0.26	0.00	0.15	0.00	0.10	0.00	0.07	0.00
50	1.06	0.04	0.51	0.01	0.30	0.00	0.20	0.00	0.14	0.00
75	1.59	0.09	0.77	0.02	0.45	0.00	0.30	0.00	0.21	0.00
100	2.12	0.16	1.02	0.03	0.59	0.01	0.40	0.00	0.28	0.00
125	2.64	0.24	1.28	0.04	0.74	0.01	0.49	0.00	0.35	0.00
150	3.17	0.34	1.54	0.06	0.89	0.02	0.59	0.01	0.42	0.00
175	3.70	0.45	1.79	0.08	1.04	0.02	0.69	0.01	0.49	0.00
200	4.23	0.58	2.05	0.10	1.19	0.03	0.79	0.01	0.56	0.00
225	4.76	0.72	2.30	0.12	1.34	0.03	0.89	0.01	0.63	0.01
250	5.29	0.88	2.56	0.15	1.49	0.04	0.99	0.01	0.70	0.01
275	5.82	1.05	2.81	0.18	1.64	0.05	1.09	0.02	0.77	0.01
300	6.35	1.23	3.07	0.21	1.78	0.06	1.19	0.02	0.84	0.01
325	6.87	1.43	3.33	0.24	1.93	0.07	1.29	0.02	0.91	0.01
350	7.40	1.63	3.58	0.28	2.08	0.07	1.38	0.03	0.98	0.01
375			3.84	0.32	2.23	0.08	1.48	0.03	1.05	0.01
400			4.09	0.36	2.38	0.10	1.58	0.04	1.12	0.02
450			4.61	0.45	2.68	0.12	1.78	0.04	1.26	0.02
500			5.12	0.54	2.97	0.14	1.98	0.05	1.40	0.02
550			5.63	0.65	3.27	0.17	2.17	0.06	1.54	0.03
600			6.14	0.76	3.57	0.20	2.37	0.08	1.68	0.03
700			7.16	1.01	4.16	0.27	2.77	0.10	1.96	0.04
800			8.19	1.29	4.76	0.35	3.16	0.13	2.24	0.05
900			9.21	1.61	5.35	0.43	3.56	0.16	2.52	0.07
1000			10.23	1.95	5.95	0.52	3.95	0.19	2.80	0.08
1100					6.54	0.62	4.35	0.23	3.08	0.10
1200					7.14	0.73	4.74	0.27	3.36	0.12
1300					7.73	0.85	5.14	0.31	3.63	0.14
1400					8.33	0.97	5.54	0.36	3.91	0.16
1500					8.92	1.11	5.93	0.41	4.19	0.18
1600					9.52	1.25	6.33	0.46	4.47	0.20
1700							6.72	0.52	4.75	0.22
1800							7.12	0.57	5.03	0.25
1900							7.51	0.63	5.31	0.27
2000							7.91	0.70	5.59	0.30
2100							8.30	0.76	5.87	0.33
2200							8.70	0.83	6.15	0.36
2300									6.43	0.39
2400									6.71	0.42
2500									6.99	0.45
2600									7.27	0.49
2700									7.55	0.52
2800									7.83	0.56
2900									8.11	0.60
3000									8.39	0.64
3100									8.67	0.68
3200										
3300										
3400										
3500										
3600										
3800										
3900										
4000										
4200										
4400										
4600										
4800										
5000										
5500										
6000										
6500										
7000										
7500										
8000										
8500										

Shaded area represents velocities over 5 fps.  
 Use with caution.

See pg 93 for friction loss formulas

FRICITION LOSS



FRICION LOSS CHARACTERISTICS

**PVC SCHEDULE 40 IPS PLASTIC PIPE**

Size: 4" thru 12"      Flow: 10 thru 3000GPM  
 ASTM D1785   C=150      PSI LOSS PER 100 FEET OF PIPE (PSI/100 FT)

size	4"		6"		8"		10"		12"	
Avg.ID	3.998		6.031		7.942		9.976		11.889	
Pipe OD	4.500		6.625		8.625		10.750		12.750	
Avg Wall	0.251		0.297		0.342		0.387		0.431	
Min Wall	0.237		0.280		0.322		0.365		0.406	
Flow GPM	Velocity FPS	PSI Loss	Velocity FPS	PSI Loss	Velocity FPS	PSI Loss	Velocity FPS	PSI Loss	Velocity FPS	PSI Loss
10	0.26	0.00	0.11	0.00	0.06	0.00	0.04	0.00	0.03	0.00
20	0.51	0.01	0.22	0.00	0.13	0.00	0.08	0.00	0.06	0.00
30	0.77	0.03	0.34	0.00	0.19	0.00	0.12	0.00	0.09	0.00
40	1.02	0.05	0.45	0.01	0.26	0.00	0.16	0.00	0.12	0.00
50	1.28	0.07	0.56	0.01	0.32	0.00	0.20	0.00	0.14	0.00
60	1.53	0.10	0.67	0.01	0.39	0.00	0.25	0.00	0.17	0.00
70	1.79	0.13	0.79	0.02	0.45	0.00	0.29	0.00	0.20	0.00
80	2.04	0.17	0.90	0.02	0.52	0.01	0.33	0.00	0.23	0.00
90	2.30	0.21	1.01	0.03	0.58	0.01	0.37	0.00	0.26	0.00
100	2.55	0.25	1.12	0.03	0.65	0.01	0.41	0.00	0.29	0.00
120	3.06	0.36	1.35	0.05	0.78	0.01	0.49	0.00	0.35	0.00
140	3.57	0.47	1.57	0.06	0.91	0.02	0.57	0.01	0.40	0.00
160	4.08	0.61	1.79	0.08	1.03	0.02	0.66	0.01	0.46	0.00
180	4.59	0.75	2.02	0.10	1.16	0.03	0.74	0.01	0.52	0.00
200	5.11	0.92	2.24	0.12	1.29	0.03	0.82	0.01	0.58	0.00
225	5.74	1.14	2.52	0.15	1.46	0.04	0.92	0.01	0.65	0.01
250	6.38	1.39	2.80	0.19	1.62	0.05	1.02	0.02	0.72	0.01
275	7.02	1.65	3.08	0.22	1.78	0.06	1.13	0.02	0.79	0.01
300	7.66	1.94	3.37	0.26	1.94	0.07	1.23	0.02	0.87	0.01
325	8.30	2.25	3.65	0.30	2.10	0.08	1.33	0.03	0.94	0.01
350	8.93	2.58	3.93	0.35	2.26	0.09	1.43	0.03	1.01	0.01
375			4.21	0.40	2.43	0.10	1.54	0.03	1.08	0.01
400			4.49	0.45	2.59	0.12	1.64	0.04	1.15	0.02
425			4.77	0.50	2.75	0.13	1.74	0.04	1.23	0.02
450			5.05	0.56	2.91	0.15	1.84	0.05	1.30	0.02
475			5.33	0.62	3.07	0.16	1.95	0.05	1.37	0.02
500			5.61	0.68	3.23	0.18	2.05	0.06	1.44	0.02
550			6.17	0.81	3.56	0.21	2.25	0.07	1.59	0.03
600			6.73	0.95	3.88	0.25	2.46	0.08	1.73	0.03
650			7.29	1.10	4.20	0.29	2.66	0.09	1.88	0.04
700			7.85	1.26	4.53	0.33	2.87	0.11	2.02	0.05
750					4.85	0.38	3.07	0.12	2.16	0.05
800					5.17	0.42	3.28	0.14	2.31	0.06
850					5.50	0.47	3.48	0.16	2.45	0.07
900					5.82	0.53	3.69	0.17	2.60	0.07
950					6.15	0.58	3.89	0.19	2.74	0.08
1000					6.47	0.64	4.10	0.21	2.89	0.09
1050					6.79	0.70	4.30	0.23	3.03	0.10
1150					7.44	0.83	4.71	0.27	3.32	0.12
1200					7.76	0.90	4.92	0.30	3.46	0.13
1250							5.12	0.32	3.61	0.14
1300							5.33	0.34	3.75	0.15
1350							5.53	0.37	3.90	0.16
1400							5.74	0.39	4.04	0.17
1500							6.15	0.45	4.33	0.19
1550							6.35	0.47	4.47	0.20
1600							6.56	0.50	4.62	0.21
1650							6.76	0.53	4.76	0.23
1700							6.97	0.56	4.91	0.24
1750							7.17	0.59	5.05	0.25
1800									5.20	0.27
1850									5.34	0.28
1900									5.48	0.29
1950									5.63	0.31
2000									5.77	0.32
2100									6.06	0.35
2200									6.35	0.39
2300									6.64	0.42
2400									6.93	0.45
2500									7.22	0.49
2600										
2700										
2800										
2900										
3000										

Shaded area represents velocities over 5 fps.  
 Use with caution.

See pg 93 for friction loss formulas

FRICION LOSS

FRICION LOSS CHARACTERISTICS

PVC SCHEDULE 80 IPS PLASTIC PIPE										
Size: 4" thru 12"					Flow: 10 thru 3000GPM					
ASTM D1785			C=150		PSI LOSS PER 100 FEET OF PIPE (PSI/100 FT)					
size	4"		6"		8"		10"		12"	
Avg.ID	3.786		5.709		7.565		9.493		11.294	
Pipe OD	4.500		6.625		8.625		10.750		12.750	
Avg Wall	0.357		0.458		0.530		0.629		0.728	
Min Wall	0.337		0.432		0.500		0.593		0.687	
Flow GPM	Velocity FPS	PSI Loss	Velocity FPS	PSI Loss	Velocity FPS	PSI Loss	Velocity FPS	PSI Loss	Velocity FPS	PSI Loss
10	0.28	0.00	0.13	0.00	0.07	0.00	0.05	0.00	0.03	0.00
20	0.57	0.02	0.25	0.00	0.14	0.00	0.09	0.00	0.06	0.00
30	0.85	0.04	0.38	0.00	0.21	0.00	0.14	0.00	0.10	0.00
40	1.14	0.06	0.50	0.01	0.29	0.00	0.18	0.00	0.13	0.00
50	1.42	0.09	0.63	0.01	0.36	0.00	0.23	0.00	0.16	0.00
60	1.71	0.13	0.75	0.02	0.43	0.00	0.27	0.00	0.19	0.00
70	1.99	0.17	0.88	0.02	0.50	0.01	0.32	0.00	0.22	0.00
80	2.28	0.22	1.00	0.03	0.57	0.01	0.36	0.00	0.26	0.00
90	2.56	0.27	1.13	0.04	0.64	0.01	0.41	0.00	0.29	0.00
100	2.85	0.33	1.25	0.04	0.71	0.01	0.45	0.00	0.32	0.00
120	3.42	0.46	1.50	0.06	0.86	0.02	0.54	0.01	0.38	0.00
140	3.98	0.62	1.75	0.08	1.00	0.02	0.63	0.01	0.45	0.00
160	4.55	0.79	2.00	0.11	1.14	0.03	0.72	0.01	0.51	0.00
180	5.12	0.98	2.25	0.13	1.28	0.03	0.81	0.01	0.58	0.00
200	5.69	1.19	2.50	0.16	1.43	0.04	0.91	0.01	0.64	0.01
225	6.40	1.49	2.82	0.20	1.60	0.05	1.02	0.02	0.72	0.01
250	7.12	1.81	3.13	0.24	1.78	0.06	1.13	0.02	0.80	0.01
275	7.83	2.15	3.44	0.29	1.96	0.07	1.25	0.02	0.88	0.01
300	8.54	2.53	3.76	0.34	2.14	0.09	1.36	0.03	0.96	0.01
325	9.25	2.94	4.07	0.40	2.32	0.10	1.47	0.03	1.04	0.01
350	9.96	3.37	4.38	0.46	2.50	0.12	1.58	0.04	1.12	0.02
375			4.69	0.52	2.67	0.13	1.70	0.04	1.20	0.02
400			5.01	0.58	2.85	0.15	1.81	0.05	1.28	0.02
425			5.32	0.65	3.03	0.17	1.92	0.06	1.36	0.02
450			5.63	0.73	3.21	0.18	2.04	0.06	1.44	0.03
475			5.95	0.80	3.39	0.20	2.15	0.07	1.52	0.03
500			6.26	0.88	3.56	0.22	2.26	0.07	1.60	0.03
550			6.88	1.05	3.92	0.27	2.49	0.09	1.76	0.04
600			7.51	1.24	4.28	0.31	2.72	0.10	1.92	0.04
650			8.14	1.44	4.63	0.36	2.94	0.12	2.08	0.05
700			8.76	1.65	4.99	0.42	3.17	0.14	2.24	0.06
750					5.35	0.48	3.40	0.16	2.40	0.07
800					5.70	0.54	3.62	0.18	2.56	0.08
850					6.06	0.60	3.85	0.20	2.72	0.09
900					6.42	0.67	4.07	0.22	2.88	0.09
950					6.77	0.74	4.30	0.24	3.04	0.10
1000					7.13	0.81	4.53	0.27	3.20	0.12
1050					7.49	0.89	4.75	0.29	3.36	0.13
1150					8.20	1.05	5.21	0.35	3.68	0.15
1200					8.56	1.14	5.43	0.38	3.84	0.16
1250							5.66	0.41	4.00	0.17
1300							5.89	0.44	4.16	0.19
1350							6.11	0.47	4.32	0.20
1400							6.34	0.50	4.48	0.22
1500							6.79	0.57	4.80	0.24
1550							7.02	0.60	4.96	0.26
1600							7.24	0.64	5.12	0.28
1650							7.47	0.68	5.28	0.29
1700							7.70	0.72	5.44	0.31
1750							7.92	0.76	5.60	0.33
1800									5.76	0.34
1850									5.92	0.36
1900									6.08	0.38
1950									6.24	0.40
2000									6.40	0.42
2100									6.72	0.46
2200									7.04	0.50
2300									7.36	0.54
2400									7.68	0.58
2500									8.00	0.63
2600										
2700										
2800										
2900										
3000										

Shaded area represents velocities over 5 fps.  
Use with caution.

See pg 93 for friction loss formulas

WATER METER PRESSURE LOSS CHART

AWWA STANDARD PRESSURE LOSSES (PSI)								
Water Meter Nominal Size								
Flow GPM	5/8"	3/4"	1"	1 1/2"	2"	3"	4"	Flow GPM
1	0.2	0.1						1
2	0.3	0.2						2
3	0.4	0.3						3
4	0.6	0.5	0.1					4
5	0.9	0.6	0.2					5
6	1.3	0.7	0.3					6
7	1.8	0.8	0.4					7
8	2.3	1.0	0.5					8
9	3.0	1.3	0.6					9
10	3.7	1.6	0.7					10
11	4.4	1.9	0.8					11
12	5.1	2.2	0.9					12
13	6.1	2.6	1.0					13
14	7.2	3.1	1.1					14
15	8.3	3.6	1.2					15
16	9.4	4.1	1.4	0.4				16
17	10.7	4.6	1.6	0.5				17
18	12.0	5.2	1.8	0.6				18
19	13.4	5.8	2.0	0.7				19
20	15.0	6.5	2.2	0.8				20
22		7.9	2.8	1.0				22
24		9.5	3.4	1.2				24
26		11.2	4.0	1.4				26
28		13.0	4.6	1.6				28
30		15.0	5.3	1.8	0.7			30
32			6.0	2.1	0.8			32
34			6.9	2.4	0.9			34
36			7.8	2.7	1.0			36
38			8.7	3.0	1.2			38
40			9.6	3.3	1.3			40
42			10.6	3.6	1.4			42
44			11.7	3.9	1.5			44
46			12.8	4.2	1.6			46
48			13.9	4.5	1.7			48
50			15.0	4.9	1.9			50
52				5.3	2.1			52
54				5.7	2.2			54
56				6.2	2.3			56
58				6.7	2.5			58
60				7.2	2.7	1.0		60
65				8.3	3.2	1.1		65
70				9.8	3.7	1.3		70
75				11.3	4.3	1.5		75
80				12.8	4.9	1.6	0.7	80
90				16.1	6.2	2.0	0.8	90
100				20.0	7.8	2.5	0.9	100
110					9.5	2.9	1.0	110
120					11.3	3.4	1.2	120
130					13.0	3.9	1.4	130
140					15.1	4.5	1.6	140
150					17.3	5.1	1.8	150
160					20.0	5.8	2.1	160
170						6.5	2.4	170
180						7.2	2.7	180
190						8.0	3.0	190
200						9.0	3.2	200
220						11.0	3.9	220
240						13.0	4.7	240
260						15.0	5.5	260
280						17.3	6.3	280
300						20.0	7.2	300
350							10.0	350
400							13.0	400
450							16.2	450
500							20.0	500
75% of max. meter capacity	15 gpm	22.5 gpm	37.5 gpm	75 gpm	120 gpm	225 gpm	375 gpm	75% of max. meter capacity

FRICTION LOSS/  
PRESSURE LOSS

## SLOPE IRRIGATION CHART

### PERCENT, ANGLE AND RATIO

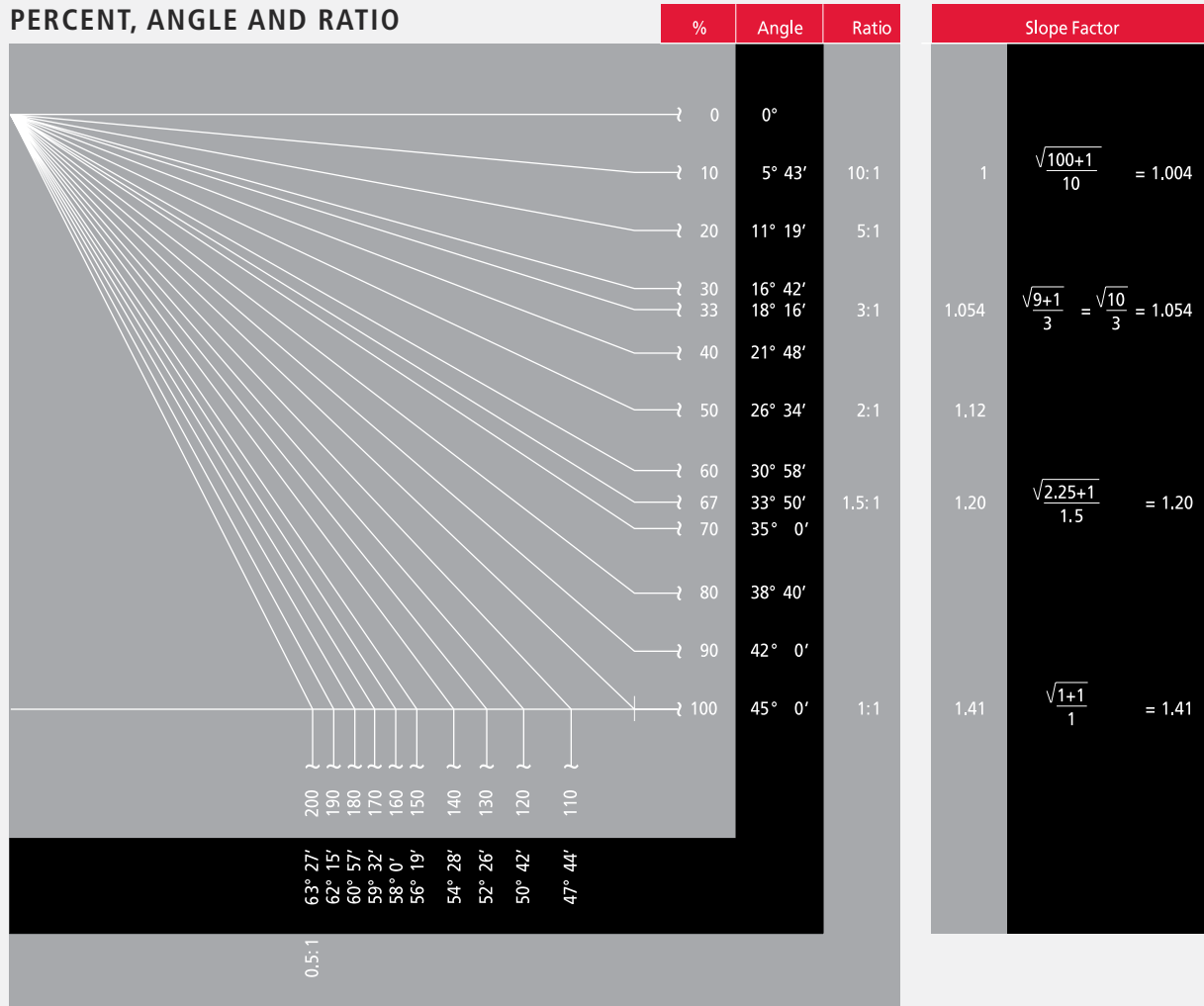

### MAXIMUM PRECIPITATION RATES

Soil Texture	Inches Per Hour							
	0 to 5% slope		5 to 8% slope		8 to 12% slope		12% + slope	
	Cover	Bare	Cover	Bare	Cover	Bare	Cover	Bare
Coarse sandy soils	2.00	2.00	2.00	1.50	1.50	1.00	1.00	0.50
Coarse sandy soils over compact subsoils	1.75	1.50	1.25	1.00	1.00	0.75	0.75	0.40
Uniform light sandy loams	1.75	1.00	1.25	0.80	1.00	0.60	0.75	0.40
Light sandy soils over compact subsoils	1.25	0.75	1.00	0.50	0.75	0.40	0.50	0.30
Uniform silt loams	1.00	0.50	0.80	0.40	0.60	0.30	0.40	0.20
Silt loams over compact subsoil	0.60	0.30	0.50	0.25	0.40	0.15	0.30	0.10
Heavy clay or clay loam	0.20	0.15	0.15	0.10	0.12	0.08	0.10	0.06

The maximum PR values listed are as suggested by the United States Department of Agriculture. The values are average and may vary with respect to actual soil condition and condition of ground cover.



## METHOD OF WIRE SIZING FOR ELECTRICAL COMPONENTS OF AN AUTOMATIC IRRIGATION SYSTEM

### Data Needed

- Maximum current draw of the electrical unit (valve or controller) in amperes (I)
- Distance in feet (one way) to the electrical unit (F)
- The allowable voltage drop in the wire without affecting functions of the electrical unit (Vd)

### Steps

1. Calculate the maximum allowable wire resistance per 1000 feet with the following formula:

$$R = \frac{*500 \times Vd}{F \times I}$$

where R = allowable wire resistance per 1000 feet.

2. Select the wire size from Chart #2 which has a resistance less than that calculated in the above formula.

**EXAMPLE:** A valve with a minimum operation voltage of 20 volts and inrush current of .30 amps is to be located 2680 ft. from a controller. The controller minimum output voltage is 24V ac.

The allowable voltage drop

$$(Vd) = 24 - 20 = 4 \text{ volts}$$

The distance to valve (F) = 2680 ft.

The current draw (I) = .3 amps

$$R = \frac{500 \times 4}{2680 \times .3} = 2.49 \text{ ohm/1000 ft.}$$

From Chart #2 we find that #14 AWG wire has slightly too much resistance. Therefore, choose #12 AWG copper wire.

The accompanying charts are useful for quick and easy selection of wire sizes for valves with standard and optional solenoids. Chart #3 is set up to provide maximum wire runs given a standard 24V ac valve with a minimum operation voltage of 20 volts and a controller output of 24V ac. Chart #4 is a multiplier factor for determining maximum wire runs for other controller output voltages and optional solenoids.

**EXAMPLE:** Determine maximum wire run to a valve with model 24V ac-D solenoid and controller output voltage of 26 volts and #14 control and ground wire.

From Chart #3 we find a length of 2590 ft. with #14 ground and control wire. From Chart #4 the multiplier factor at 26V ac controller output with a model 24V ac-D solenoid is 4.33. Therefore, the maximum wire distance to the valve is: 4.33 x 2590 feet = 11,215'.

\* This assumes control wire and ground wire are the same size.

## MINIMUM OPERATING VOLTAGES AT VARIOUS STATIC PRESSURES (standard 24V ac solenoid)

### CHART 1

Minimum Solenoid Operation Voltage Under Various Line Pressure

Line Pressure	Voltage (Internal Bleed Configuration)	Voltage (External Bleed Configuration)
200 psi	21.1	
175 psi	20.2	
150 psi	19.1	20.0
125 psi	18.2	19.1
100 psi	17.1	18.2
75 psi	16.1	17.3
50 psi	16.0	16.4

### CHART 2

Copper Wire Resistance of Various Sizes

Size AWG	Resistance at 20°C Ohms per 1000 ft.
4	.25
6	.40
8	.64
10	1.02
12	1.62
14	2.57
16	4.10
18	6.51

### CHART 3

Maximum One-Way Distance (ft) Between Controller and Valve (Standard 24V ac Solenoid)\*

Ground Wire	Valve Wire Sizing						
	CONTROL WIRE						
	18	16	14	12	10	8	6
18	1020	1260	1470	1640	1770	1860	1930
16	1260	1630	2000	2330	2610	2810	2960
14	1470	2000	2590	3180	3710	4150	4480
12	1640	2330	3180	4120	5050	5900	6590
10	1770	2610	3710	5050	6540	8030	9380
8	1860	2810	4150	5900	8030	10400	12770
6	1930	2960	4480	6590	9380	12770	16540

\* Solenoid Models: 24V ac, Pressure: 150 psi, Voltage Drop: 4 V, Min Op. Voltage: 20 V Amperage (peak): 0.3A

## MULTIPLIER FACTOR FOR VARIOUS CONTROLLER OUTPUT VOLTAGES AND OPTIONAL LOW VOLTAGE SOLENOIDS

### CHART 4

Controller Output Voltage	24-VOLT SOLENOID		
	24V ac	24V ac-D	24V DC
28	2.00	5.79	5.45
27	1.75	5.05	4.77
26	1.50	4.33	4.09
25	1.25	3.61	3.41
24	1.00	2.88	2.73
23	.75	2.16	2.05
22	.50	1.44	1.36

### CHART 5

Controller Output Voltage	12-VOLT SOLENOID		
	12V ac	12V ac-D	12V DC
16	.58	2.50	1.96
15	.50	2.08	1.63
14	.41	1.67	1.30
13	.33	1.25	.98
12	.25	.83	.65
11	.17	.42	.33

# INTRODUCING THE MOST EXCITING NEW MOBILE APP IN THE INDUSTRY

View products by category



Obtain product details



Quickly access how-to videos



Easily view product images



This FREE app is designed to save you valuable time by putting everything **Irritrol** in one place. Find the latest information on:

- Promotions
- Installation guides
- Bidding specifications
- How-to videos
- Product images
- And much, much more...



**PRO ONLY**

Download FREE at



**Irritrol**<sup>®</sup>  
For Professionals Only.™

# TRADE WARRANTY

**Excluding software and products formerly produced under the Rain Master™ brand name, Irritrol® offers the following coverage to its trade customers:**

For the first year from the date of original sale to the trade customer, “hassle-free” over-the-counter exchange of products found to have original manufacturing defects; and for years two through five from the date of original sale to the trade customer, repair or replacement—at our option and without charge—of all parts which are found to have original manufacturing defects, provided the product is returned to the original place of purchase or sent to the Irritrol repair facility at 5825 Jasmine St., Riverside, CA 92504, at the customer’s expense.

All Rain Master “R M E” Series Controllers have a 5-year (5-yr) warranty; all other Rain Master products have a 2-year (2-yr) warranty. A 3-year (3-yr) warranty applies to the following products: the KwikDial® controller, and the Wireless RainSensor®; a 2-year (2-yr) warranty applies to: the JR Max™ controller, the CRR, 430R, TITAN, and drip zone kit filter and pressure regulator.

All PC-related software, which includes but is not limited to, PCW Control, Evolution, AIM, Advanced ET, OASIS, Weather Station, etc, have a 90-day warranty. All computer hardware purchased from Irritrol in conjunction with its PC-related software is **NOT** covered by any Irritrol warranty. Computer hardware and its installed operating system(s) is specifically covered by the hardware manufacturer’s warranty as provided by the hardware manufacturer.

This warranty does not apply to loss or damage to the product due to improper installation, abuse, alteration, mishandling, accident, or if the product has been serviced by other than Irritrol or its authorized service centers. This warranty is not a consumer warranty and does not extend to anyone other than those trade customers who purchase Irritrol products.

**NOTE: Irritrol is not liable for (i) failure of products not manufactured by Irritrol even though such products may be sold or used in conjunction with Irritrol products; (ii) indirect, incidental or consequential damages, including but not limited to vegetation loss during periods of malfunction or resulting non-use; (iii) any loss or damage (e.g., property damage) resulting from an installer’s negligence; or (iv) implied warranties of merchantability or fitness for a particular purpose. Some states do not allow the exclusion of incidental or consequential damages, so the above exclusion may not apply to you.**

In no event shall Irritrol be liable or in any way responsible for any damages or defects in the product which were caused by repairs or attempted repairs performed by anyone other than an authorized Irritrol /Service dealer or center.

This warranty supersedes all previous warranties and shall be the sole and exclusive warranty granted by Irritrol and shall be the sole and exclusive remedy available to the trade customer. Correction of defects, in the manner and period of time described herein, shall constitute complete fulfillment of all liabilities and responsibilities of Irritrol to the trade customer with respect to the product, and shall constitute full satisfaction of all claims, whether based on contract, negligence, strict liability or otherwise.

NOTE: The user is cautioned that changes and modifications made to the equipment without the express written consent of the manufacturer will void this warranty.

SERVICE: Irritrol Technical Services: 1-800-634-8873

Irritrol Controller Repair: 1-800-899-2058

Rain Master® Control Systems: 1-800-777-1477

# Irritrol®

For Professionals Only.™

**PRO ONLY**

Only one major irrigation brand is totally dedicated to the professional. That brand is Irritrol. Everything we design and manufacture goes to you. The pros. The ones who make their living installing and selling what we make. Which means we don't sell to big box stores or hardware centers.

Since 1967, we've dedicated everything we do to just the pros. You're the ones who built our company. You're the ones who'll keep building our company. **And in our book, loyalty is a very big thing.**

## HEADQUARTERS

5825 Jasmine St  
Riverside, CA 92504-1183

Tel 800-634-TURF (8873)

Fax 800-862-8676

[www.irritrol.com](http://www.irritrol.com)